

## Conductive Polymer Aluminum Solid Capacitors

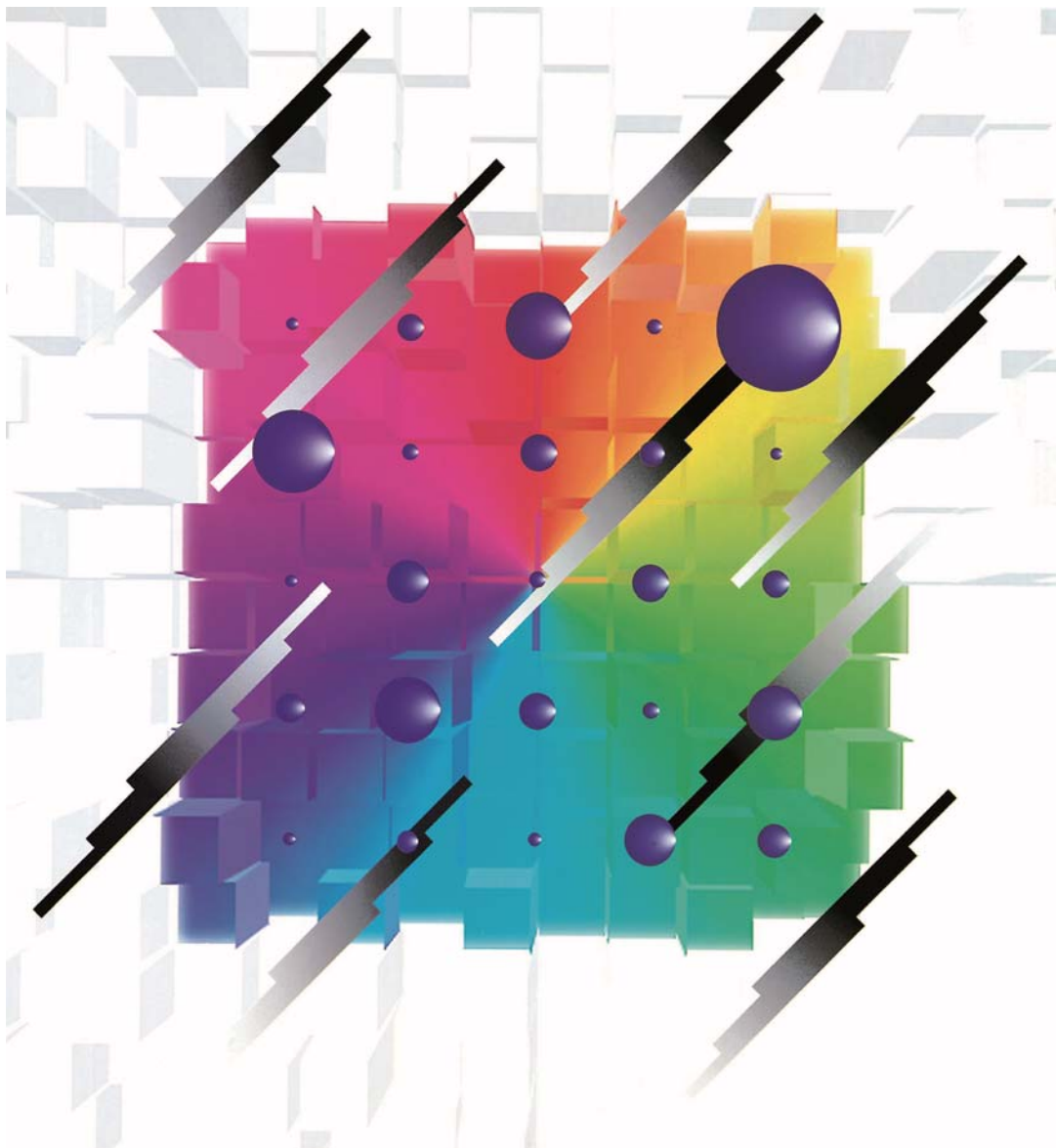

## Notices

### ■ Applicable laws and regulations

- This product complies with the RoHS Directive (Restriction of the use of certain hazardous substances in electrical and electronic equipment (DIRECTIVE 2011/65/EU).
- No Ozone Depleting Chemicals(ODC's), controlled under the Montreal Protocol Agreement, are used in producing this product.  
We do not use PBBs or PBDEs as brominated flame retardants.
- Export procedure which followed export related regulations, such as foreign exchange and a foreign trade method, on the occasion of export of this product.
- These products are not dangerous goods on the transportation as identified by UN(United Nations) numbers or UN classification.

### ■ Limited applications

- This capacitor is designed to be used for electronics circuits such as audio/visual equipment, home appliances, computers and other office equipment, optical equipment, measuring equipment.
- High reliability and safety are required [ be / a possibility that incorrect operation of this product may do harm to a human life or property ] more. When use is considered by the use, the delivery specifications which suited the use separately need to be exchanged.

## Items to be observed

### ■ For specification

- This specification guarantees the quality and performance of the product as individual components.  
Before use, check and evaluate their compatibility with installed in your products.
- Do not use the products beyond the specifications described in this document.

### ■ Upon application to products where safety is regarded as important

Install the following systems for a failsafe design to ensure safety if these products are to be used in equipment where a defect in these products may cause the loss of human life or other signification damage, such as damage to vehicles (automobile, train, vessel), traffic lights, medical equipment, aerospace equipment, electric heating appliances, combustion/ gas equipment, rotating rotating equipment, and disaster/crime prevention equipment.

- (1) The system is equipped with a protection circuit and protection device.
- (2) The system is equipped with a redundant circuit or other system to prevent an unsafe status in the event of a single fault.

### ■ Conditions of use

- Before using the products, carefully check the effects on their quality and performance, and determined whether or not they can be used. These products are designed and manufactured for general-purpose and standard use in general electronic equipment. These products are not intended for use in the following special conditions.
  - (1) In liquid, such as Water, Oil, Chemicals, or Organic solvent.
  - (2) In direct sunlight, outdoors, or in dust.
  - (3) In vapor, such as dew condensation water of resistive element, or water leakage, salty air, or air with a high concentration corrosive gas, such as Cl<sub>2</sub>, H<sub>2</sub>S, NH<sub>3</sub>, SO<sub>2</sub>, or NO<sub>x</sub>.
  - (4) In an environment where strong static electricity or electromagnetic waves exist.
  - (5) Mounting or placing heat-generating components or inflammables, such as vinyl-coated wires, near these products.
  - (6) Sealing or coating of these products or a printed circuit board on which these products are mounted, with resin and other material.
  - (7) Using res solvent, water or water-soluble cleaner for flux cleaning agent after soldering. (In particular, when using water or a water-soluble cleaning agent, be careful not to leave water residues)
  - (8) Using in the atmosphere which strays acid or alkaline.
  - (9) Using in the atmosphere which there are excessive vibration and shock.
- Please arrange circuit design for preventing impulse or transitional voltage.  
Do not apply voltage, which exceeds the full rated voltage when the capacitors receive impulse voltage, instantaneous high voltage, high pulse voltage etc.
- Our products there is a product are using an electrolyte solution. Therefore, misuse can result in rapid deterioration of characteristics and functions of each product. Electrolyte leakage damages printed circuit and affects performance, characteristics, and functions of customer system.

## ⚠ Guidelines and precautions (OS-CON)

### 1. Circuit design

#### 1.1 Prohibited circuits

- (1) Leakage current of the OS-CON may increase in the following conditions.
    - (a) Soldering
    - (b) When voltage is not applied : high temperature no-load test, high temperature and high humidity no-load test, rapidly changing temperature test, etc.
  - (2) Avoid the use of the OS-CON in the following type of circuits because leakage current may increase.
    - (a) High-impedance circuits
    - (b) Coupling circuits
    - (c) Time constant circuits
    - (d) Other circuits that are significantly affected by leakage current.
- \* If you plan to use 2 or more OS-CONs in a series connection, please contact us before use.

#### 1.2 Failure and life-span

The failure rate is 0.5 % /1000 h (Confidence level : 60 %) based on JIS C 5003.

The prospective failure is not zero. The mainly failure modes are as follows.

##### 1.2-1 Contingency failure

The most common failure mode is a short circuit. Mainly caused by the soldering or operating temperature environment, along with heat stresses, electrical stresses or mechanical stresses as follows.

- Applying voltage over the rated voltage.
- Applying reverse voltage
- Excessive mechanical stress
- Applying rush current by sudden charge or discharge out of the specification.

- (1) The following phenomenon is seen when short-current is applied to the OS-CON.
  - (a) When current is relatively low. ( $\phi 10$  : approx 1 A or less,  $\phi 8$  : approx 0.5 A or less,  $\phi 6.3$  : approx 0.2 A or less)

The OS-CON becomes heated, but no effects are visible even when the current is continuously carried.
  - (b) When the short circuit currents exceed the mentioned value above.

After internal temperature increase, sealing rubber may be turned over.  
In some cases, odorous gas may be produced.
- (2) In case a short circuit occurs, ensure safety by fully considering the followings.
  - (a) If odorous gas is released, turn off the main power of the equipment.

In this case, keep your face and hands away from the area.
  - (b) Though it depends on the conditions, it takes seconds to minutes before odorant gas generates.

Protective circuit should operate in this period.
  - (c) If the gas comes into eyes, rinse immediately. If the gas is inhaled, gargle immediately.
  - (d) Do not lick the electrolyte. If the electrolyte touches skin, wash it off with soap immediately.
  - (e) The OS-CON contains combustible substances. In case a large current continues to flow after a short circuit, in the worst case, the shorted-out section may ignite. For safety, install a redundant circuit or a protective circuit, etc.

##### 1.2-2 Wear-out failure (life time)

When lifetime span exceeded the specified guarantee time of endurance and damp heat, electrolyte might insulate and cause electric characteristic changed. This is called an open circuit.

The electric characteristics of capacitance and ESR may possibly change within the specified range in specifications even if it is used under the condition of the rated voltage, electric and mechanical performance. Please note it when designing.

## 1.3 Leakage current

Mechanical stress may cause OS-CON's leakage current increased.

In such a case, leakage current will gradually decrease by applying voltage (within the category voltage and the upper limit of category temperature).

Then, self-healing speed of leakage current is faster when it is near to the upper limit of category temperature and the category voltage.

OS-CON  
leakage current restoration characteristics  
16 V.DC / 10  $\mu$ F (16 V.DC applied)

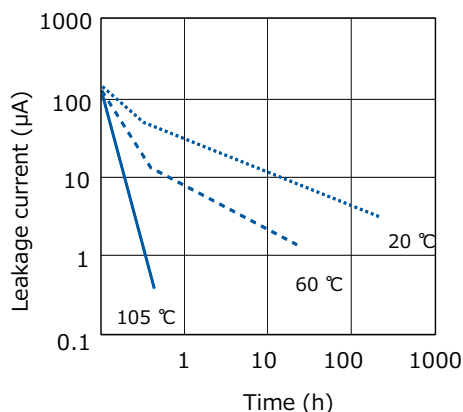

OS-CON  
leakage current restoration characteristics  
10 V.DC / 33  $\mu$ F (Ambient temperature 65 °C)  
(Measured voltage 10 V)

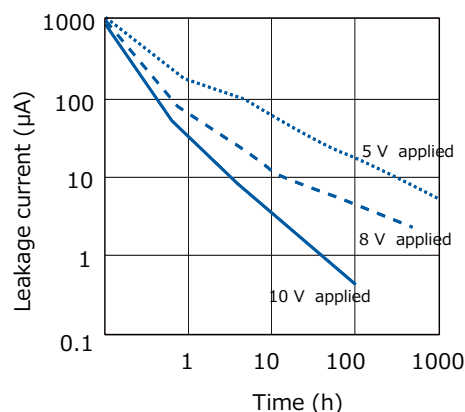

※ To make the recovery of LC values easy to show, samples that LC values have been increased on purpose are used in the test.

## 1.4 Rapid charge and discharge limitation

Allowance of a large rush current to flow due to rapid charge and discharge may result in short circuit or large leakage current. The protection circuit, to maintain high reliability, is recommended when rush current to flow to the OS-CON is in the following cases.

- (1) Products which 10 times of allowable ripple current is less than 10 A : It is when 10 A or over of rush current is applied.
- (2) Products which 10 times of allowable ripple current is 10 A or over : It is when rush current, which the figure is over 10 times of allowable ripple current, is applied.

## 2. Mounting

### 2.1 Soldering with a soldering iron

- (1) When lead terminals for radial lead type must be processed because the lead pitch and the PCB holes do not match, process them without any stresses to the OS-CON before soldering.
- (2) Solder without any excessive stresses to the OS-CON itself.
- (3) When the OS-CON has been soldered once and needs to be removed, remove it after the solder has been completely melted.
- (4) Do not let the tip of the soldering iron touch the OS-CON itself.

### 2.2 Flow soldering

- (1) Do not apply flow soldering to OS-CON SMD type.
- (2) Do not solder the OS-CON itself by submerging it in melted solder.
- (3) Solder the opposite side that the OS-CON is mounted on.
- (4) Note that flux does not adhere to anywhere except the lead terminal.
- (5) Note that other components do not fall over and touch the OS-CON when soldering.

### 2.3 Reflow soldering

- (1) Do not apply reflow soldering to OS-CON Radial Lead type.
- (2) Please contact us for setting VPS conditions.

## 2.4 Capacitor handling after soldering

Do not subject the OS-CON to excessive stress as follows.

- (1) Do not tilt, bend or twist the OS-CON.
- (2) Do not move the PCB with holding the OS-CON itself.
- (3) Do not hit the OS-CON with objects.
- (4) When stacking PCBs, make sure that the OS-CON does not touch other PCBs or components.

## 2.5 Circuit board cleaning

Check the following items before washing PC board with these detergents: high quality alcohol-based cleaning fluid such as Pine-a ST-100S, clean thru 750H, 750L, 710M, 750K or Techno Care FRW 14 through 17 or detergents including substitute freon as AK-225AES or IPA.

- (1) Use immersion or ultrasonic waves to clean within 2 minutes.
- (2) The temperature of the cleaning fluid should be less than 60 °C.
- (3) Watch the contamination of the detergent such as conductivity, pH, specific gravity, water content, etc.
- (4) Do not store the OS-CON in a location subject to gases from the cleaning fluid or in an airtight container after cleaning.
- (5) Dry the PCB or OS-CON with hot air that should be less than the upper category temperature.
- (6) Please note that indication may disappear when rubbing print side after washing depending on a cleaner.
- (7) Please contact us for details about detergents, cleaning methods and detergents other than those listed above.

## 2.6 Fixatives and coating materials

- (1) Select the appropriate covering and sealant materials for the OS-CON. In particular, don't use acetone in the fixative, coating agent and diluent.
- (2) Before applying the fixative or coating, completely remove any flux residue and foreign matter from the area where the board and the OS-CON will be jointed together.
- (3) Allow any detergent to dry before applying the fixative or coating.
- (4) Please contact us for the fixative and coating heat curing conditions.

## 2.7 Capacitor insulation

Be sure to completely separate the case, negative lead terminal, positive lead terminal and PC board patterns with each other due to the following reasons.

- (1) Insulation is not guaranteed at a part of resin on the surface of a case.
- (2) It offers inconstant resistance between a case and a negative lead terminal and it isn't insulated.

## 3. Storage

Open the bags just before mounting and use up all products once opened,  
For keeping a good solderability, store the OS-CON as follows.

		Before unsealing	After unsealing
SMD type <sup>*1</sup>		Within 24 months after shipment	Within 30 days from opening (packaged with carrier tape)
Radial lead type	Bag packing product	Within 30 months after shipment	Within 7 days from opening
	Taping product	Within 24 months after shipment	

\*1 : The JEDEC J-STD-020 standard is not applicable

### \* Intellectual property right

We, Panasonic Group are providing the product and service that customers can use without anxiety, and are working positively on the protection of our products under intellectual property rights.

Representative patents relating to OS-CON are as follows:

US Patent No. 6310765, 6508846 and 7158367

### Line up

#### SMD type

Series	Features	Small size/Low profile	Large cap.	Low ESR	High voltage	Long life/High reliability	Category tem. range (°C)	Rated voltage range (V.DC)	ESR (mΩ)	Rated cap. range (μF)	Size code	Size (mm)	
												ΦD	L
SVF	High voltage Large capacitance 125°C 1000 h		●		●	●	-55 to 125	16 to 25	27 to 40	27 to 82	B6	5.0	5.9
							-55 to 125	16 to 50	22 to 40	10 to 180	C6	6.3	5.9
							-55 to 125	16 to 50	22 to 35	18 to 270	E7	8.0	6.9
							-55 to 125	16 to 50	14 to 25	39 to 560	E12	8.0	11.9
							-55 to 125	16 to 50	12 to 20	68 to 1000	F12	10.0	12.6
UPGRADE SVPK	High voltage Large capacitance 125°C 1000 h		●		●	●	-55 to 125	16 to 50	27 to 80	10 to 100	B6	5.0	5.9
							-55 to 125	16 to 50	22 to 35	22 to 220	C6	6.3	5.9
							-55 to 125	16 to 50	22 to 35	33 to 330	E7	8.0	6.9
							-55 to 125	16 to 50	14 to 25	68 to 680	E12	8.0	11.9
							-55 to 125	16 to 50	12 to 20	120 to 1200	F12	10.0	12.6
UPGRADE SXV	Super high voltage 125°C 1000 h				●	●	-55 to 125	63 to 100	60	6.8 to 18	E7	8.0	6.9
							-55 to 125	63 to 100	50 to 60	15 to 39	F8	10.0	7.9
							-55 to 125	63 to 100	25 to 40	15 to 56	E12	8.0	11.9
							-55 to 125	63 to 100	25 to 30	18 to 100	F12	10.0	12.6
SVPG	Low ESR High ripple current 105°C 5000 h			●	●		-55 to 105	16 to 25	25 to 30	15 to 47	B45	5.0	4.4
							-55 to 105	16	10	270	C8	6.3	7.9
							-55 to 105	16	8	270	C10	6.3	9.9
SVPF	High voltage Large capacitance 105°C 5000 h	●		●	●		-55 to 105	16 to 25	27 to 40	27 to 82	B6	5.0	5.9
							-55 to 105	16 to 50	22 to 40	10 to 180	C6	6.3	5.9
							-55 to 105	16 to 50	22 to 35	18 to 270	E7	8.0	6.9
							-55 to 105	16	18	560	E10	8.0	10.0
							-55 to 105	16 to 50	14 to 25	39 to 560	E12	8.0	11.9
							-55 to 105	16 to 50	12 to 20	68 to 1000	F12	10.0	12.6
SVPA	Low ESR High ripple current			●			-55 to 105	2.5 to 20	30 to 40	10 to 82	B6	5.0	5.9
							-55 to 105	2.5 to 20	20 to 35	22 to 180	C6	6.3	5.9
							-55 to 105	2.5 to 20	20 to 33	47 to 330	E7	8.0	6.9
							-55 to 105	2.5 to 16	19 to 29	180 to 820	F8	10.0	7.9
SVPB	Low profile	●					-55 to 105	2.5 to 20	40 to 45	15 to 120	C5	6.3	4.9
							-55 to 105	20	35	22	C55	6.3	5.4
SVPC	Low ESR Large capacitance	●	●				-55 to 105	2.5 to 16	19 to 35	39 to 180	B6	5.0	5.9
							-55 to 105	2.5 to 16	15 to 30	68 to 560	C6	6.3	5.9
							-55 to 105	2.5 to 16	19 to 27	120 to 680	E7	8.0	6.9
							-55 to 105	2.5 to 16	9 to 16	270 to 1500	E12	8.0	11.9
							-55 to 105	2.5	12	2700	F12	10.0	12.6
SVPD	Guaranteed at 125°C High voltage 85°C 85 % RH				●	●	-55 to 125	10 to 25	45 to 65	10 to 56	C6	6.3	5.9
							-55 to 125	16 to 35	40 to 70	8.2 to 82	E7	8.0	6.9
							-55 to 125	25 to 35	45 to 60	18 to 39	F8	10.0	7.9
							-55 to 125	25 to 35	30 to 50	22 to 47	E12	8.0	11.9
							-55 to 125	25 to 35	28 to 30	47 to 82	F12	10.0	12.6

### Line up

#### SMD type

Series	Features	Small size/Low profile	Large cap.	Low ESR	High voltage	Long life/High reliability	Category tem. range (°C)	Rated voltage range (V.DC)	ESR (mΩ)	Rated cap. range (μF)	Size code	Size (mm)	
												ΦD	L
SVPE	Super low ESR Large capacitance		●	●			-55 to 105	2.5 to 6.3	10 to 15	150 to 390	B6	5.0	5.9
							-55 to 105	2.5 to 10	10 to 20	220 to 390	C6	6.3	5.9
							-55 to 105	2.5 to 16	8 to 11	180 to 1200	C10	6.3	9.9
							-55 to 105	16	10	470	F12	10.0	12.6
SVPS	Long life				●		-55 to 105	4.0 to 10	200 to 220	10 to 33	A5	4.0	5.4
							-55 to 105	4.0 to 16	30 to 90	22 to 68	B6	5.0	5.9
							-55 to 105	4.0 to 20	22 to 60	22 to 150	C6	6.3	5.9
							-55 to 105	4.0 to 25	22 to 60	10 to 270	E7	8.0	6.9
							-55 to 105	4.0 to 16	20 to 35	100 to 680	F8	10.0	7.9
SVQP	Guaranteed at 125°C				●		-55 to 105	4.0 to 20	40 to 60	22 to 150	C6	6.3	5.9
							-55 to 105	6.3 to 20	35 to 45	47 to 220	E7	8.0	6.9
SVP	Standard						-55 to 105	4.0 to 16	200 to 260	3.3 to 33	A5	4.0	5.4
							-55 to 105	4.0 to 20	60 to 120	10 to 68	B6	5.0	5.9
							-55 to 105	2.5 to 20	23 to 60	22 to 220	C6	6.3	5.9
							-55 to 105	4.0 to 20	35 to 45	33 to 330	E7	8.0	6.9
							-55 to 105	4.0 to 20	25 to 40	56 to 680	F8	10.0	7.9
							-55 to 105	2.5 to 20	13 to 24	100 to 680	E12	8.0	11.9
-55 to 105	2.5 to 20	12 to 20	150 to 1500	F12	10.0	12.6							

### Line up

#### Radial lead type

Series	Features	Small size/Low profile	Large cap.	Low ESR	High voltage	Long life/High reliability	Category tem. range (°C)	Rated voltage range (V.DC)	ESR (mΩ)	Rated cap. range (μF)	Size code	Size (mm)	
												ΦD	L
SEF	High voltage Large capacitance 125°C 1000 h		●	●	●		-55 to 125	16 to 35	22 to 35	22 to 180	C6	6.3	5.9
							-55 to 125	16 to 35	22 to 30	39 to 270	E7	8.0	6.9
							-55 to 125	16 to 35	14 to 20	82 to 560	E12	8.0	11.9
							-55 to 125	16 to 5	12 to 18	120 to 1000	F13	8.0	12.9
SEK	High voltage Large capacitance 125°C 1000 h		●	●	●		-55 to 125	25 to 50	25 to 35	22 to 82	C6	6.3	5.9
							-55 to 125	25 to 50	24 to 35	33 to 120	E7	8.0	6.9
							-55 to 125	25 to 50	16 to 25	68 to 270	E12	8.0	11.9
							-55 to 125	25 to 50	14 to 20	120 to 470	F13	8.0	12.9
UPGRADE SEPG	Low ESR High ripple current 105°C 5000 h			●	●		-55 to 105	16	10	270	C9	10.0	8.9
							-55 to 105	16	8	270	C10	6.3	9.9
							-55 to 105	16	8	470	E9	8.0	8.9
							-55 to 105	16	8	560	E13	8.0	12.9
UPGRADE SXE	Super high voltage 125°C 1000 h				●	●	-55 to 125	63 to 100	60	6.8 to 18	E7	8.0	6.9
							-55 to 125	63 to 100	50 to 60	15 to 39	F8	8.0	7.9
							-55 to 125	63 to 100	25 to 40	15 to 56	E12	8.0	11.9
							-55 to 125	63 to 100	25 to 30	18 to 100	F13	8.0	12.9
SEPF	Small size Low profile High voltage Large capacitance 105°C 5000 h	●	●		●	●	-55 to 105	16 to 32	30 to 35	22 to 150	C55	6.3	5.4
							-55 to 105	16 to 35	22 to 35	22 to 180	C6	6.3	5.9
							-55 to 105	16 to 35	22 to 30	39 to 270	E7	8.0	6.9
							-55 to 105	16 to 35	14 to 20	82 to 560	E12	8.0	11.9
							-55 to 105	16 to 35	12 to 18	120 to 1000	F13	10.0	12.9
SEPC	Super low ESR Large capacitance Small size Low profile 105°C 5000 h	●	●	●	●	●	-55 to 105	2.5	7	100 to 560	B9	5.0	8.9
							-55 to 105	6.3	18	220	C55	6.3	5.4
							-55 to 105	2.5 to 16	10 to 24	100 to 560	C6	6.3	5.9
							-55 to 105	2.5 to 16	7 to 10	100 to 820	C9	6.3	8.9
							-55 to 105	2.5 to 16	8 to 22	150 to 1000	E7	8.0	6.9
							-55 to 105	2.5 to 16	5 to 10	180 to 1000	E9	8.0	8.9
							-55 to 105	16	11 to 16	180 to 270	E12	8.0	11.9
							-55 to 105	2.5 to 6.3	7 to 8	470 to 820	E13	8.0	12.9
SEQP	105°C 5000 h Guaranteed at 125°C Rated 32 V.DC max.				●	●	-55 to 125	4.0 to 20	40 to 60	22 to 150	C6	6.3	5.9
							-55 to 125	4.0 to 32	35 to 100	6.8 to 330	E7	8.0	6.9
							-55 to 125	4.0 to 32	25 to 80	15 to 680	F8	10.0	7.9
							-55 to 125	4.0 to 32	13 to 50	18 to 560	E12	8.0	11.9
							-55 to 125	4.0 to 20	12 to 20	150 to 1200	F13	10.0	12.9
SEP	Standard				●	●	-55 to 105	4.0 to 20	40 to 60	22 to 150	C6	6.3	5.9
							-55 to 105	4.0 to 20	35 to 45	33 to 330	E7	8.0	6.9
							-55 to 105	4.0 to 20	25 to 40	56 to 680	F8	10.0	7.9
							-55 to 105	2.5 to 20	13 to 24	100 to 680	E12	8.0	11.9
							-55 to 105	2.5 to 20	12 to 20	150 to 1500	F12	10.0	12.9
							-55 to 105	2.5 to 20	12 to 20	150 to 1500	F12	10.0	12.9



### Diagram

● SMD type

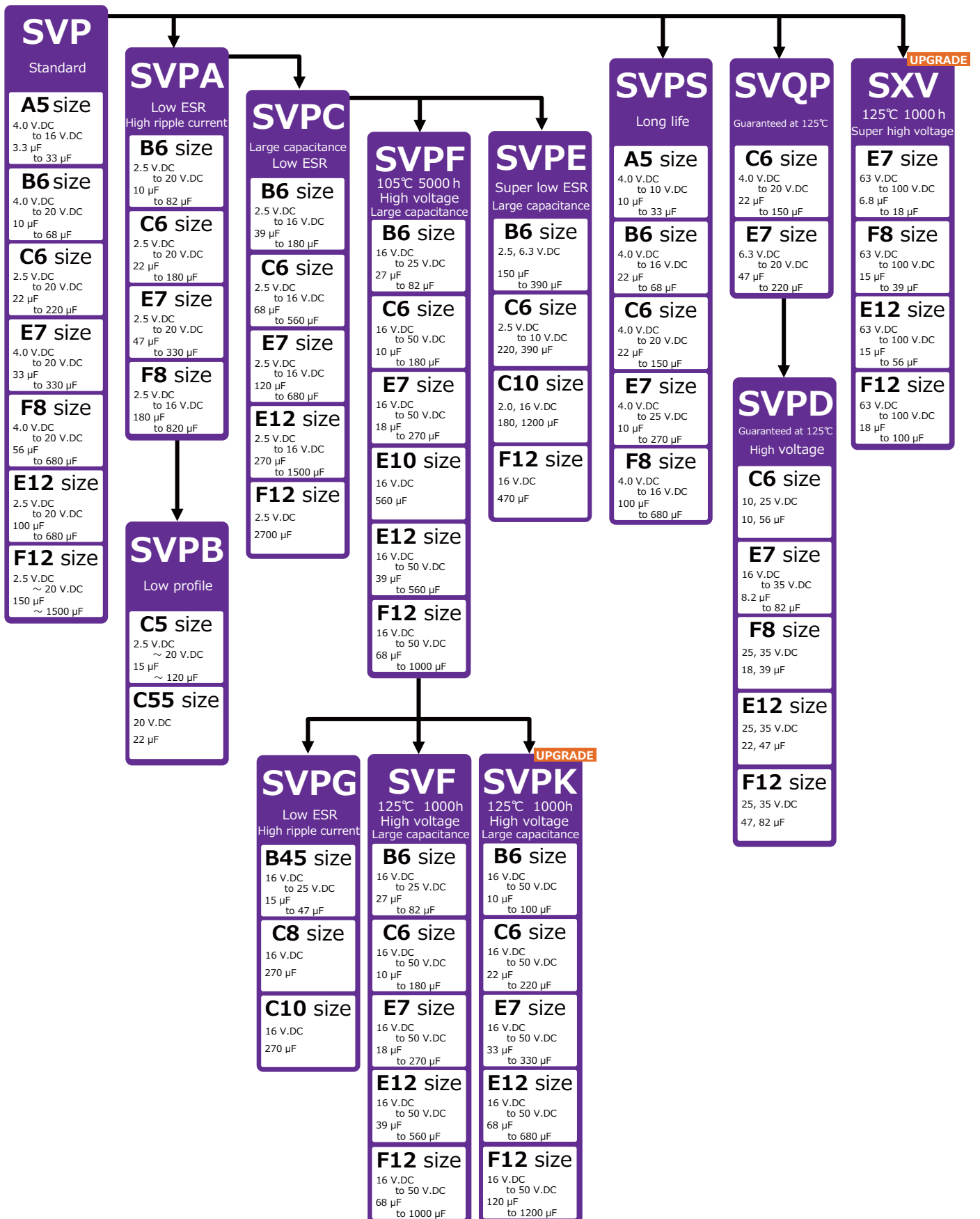

### Diagram

- Radial lead type

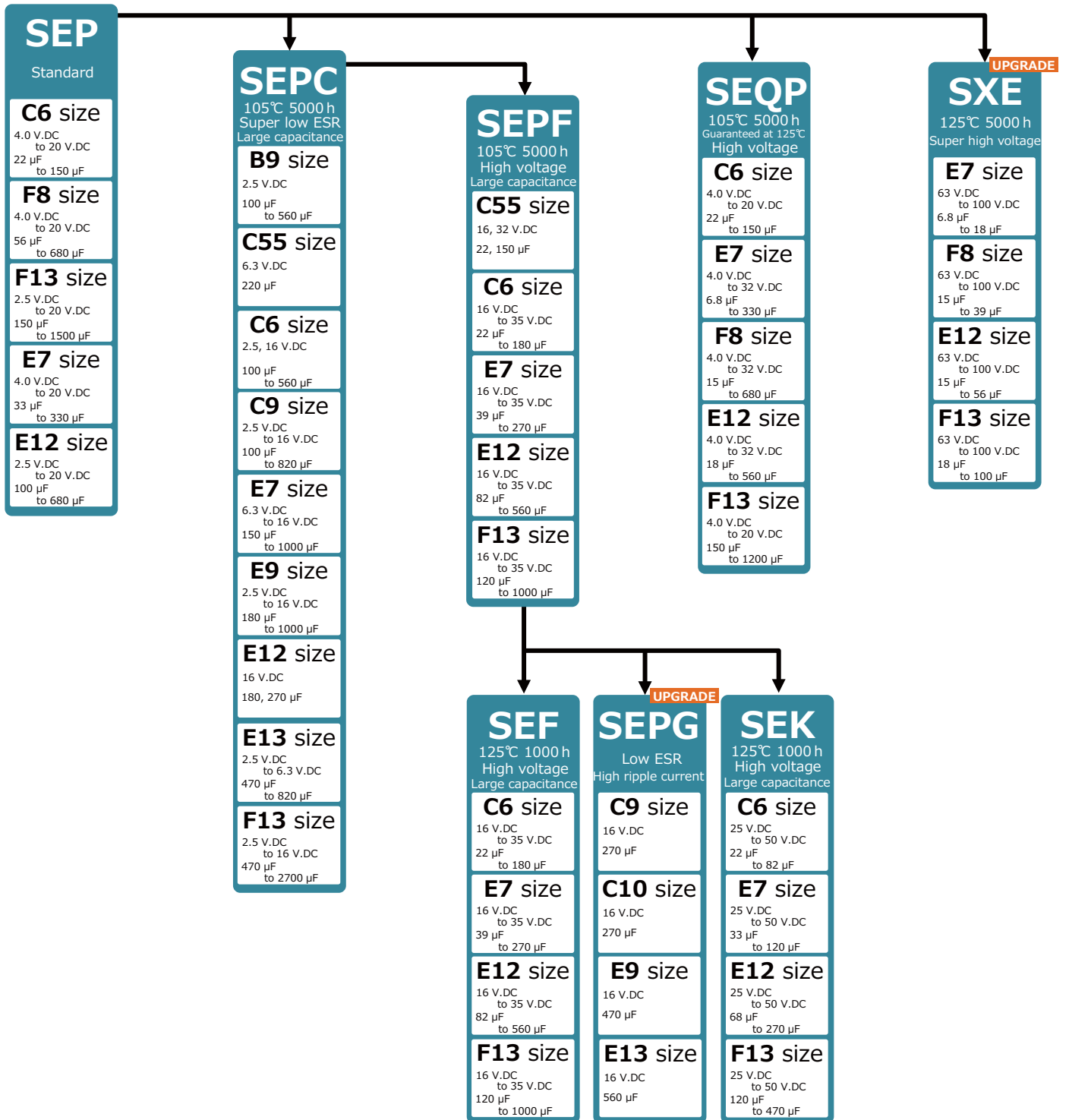

### Explanation of part numbers

#### ◇ Part number system

##### ·Surface mount type

16		SVP		3R3		M	
Rated voltage		Series		Rated capacitance		Capacitance tolerance	
Rated volt. (V.DC)	Code	Series		Rated cap. (μF)	Code	Cap. tolerance	Code
2.0	2	SVF		3.3	3R3	±20%	M
2.5	2R5	SVPK		4.7	4R7		
4.0	4	SXV		10	10		
6.3	6	SVPG		22	22		
10	10	SVPF		100	100		
16	16	SVPA		220	220		
20	20	SVPB		470	470		
25	25	SVPC		1500	1500		
35	35	SVPD					
100	100	SVPE					
		SVPS					
		SVQP					
		SVP					

##### ·Radial lead type

16		SEPC		470		M		+ T	
Rated voltage		Series		Rated capacitance		Capacitance tolerance		Taping or forming of terminal code	
Rated volt. (V.DC)	Code	Series		Rated cap. (μF)	Code	Cap. tolerance	Code	<div style="border: 1px solid black; padding: 5px;">                     Taping of lead terminal wire process code.                      None suffix for regular length lead type products.                 </div>	
2.5	2R5 <sup>※1</sup>	SEF		6.8	6R8	±20%	M		
4.0	4	SEK		10	10				
6.3	6	SEPG		22	22				
10	10	SXE		100	100				
16	16	SEPC		220	220				
20	20	SEPF		470	470				
25	25	SEQP		1000	1000				
32	32	SEP		2700	2700				
100	100								

※1 Code 2 is used for 2.5 V products of B9, C6, C9, E7, E9 and F13 size in SEPC series.

### Mounting specifications

#### ◇ Recommendable reflow soldering

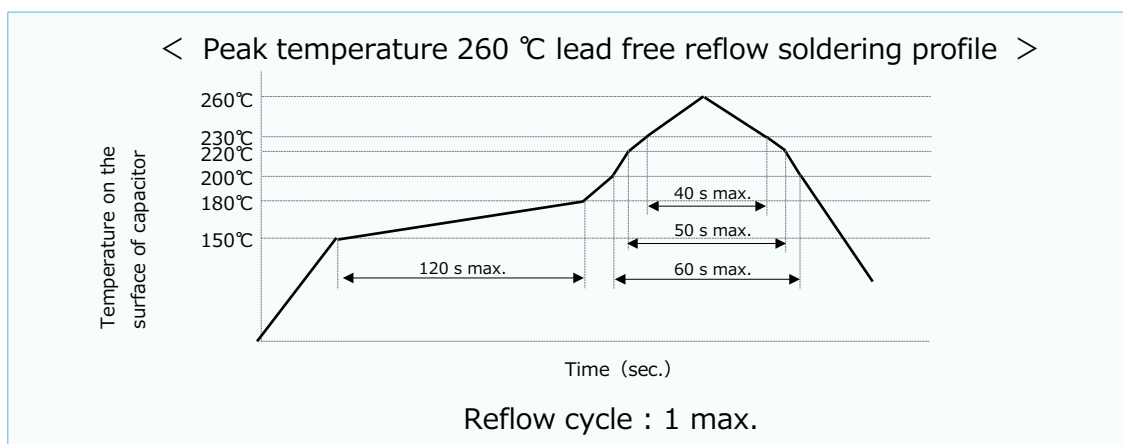
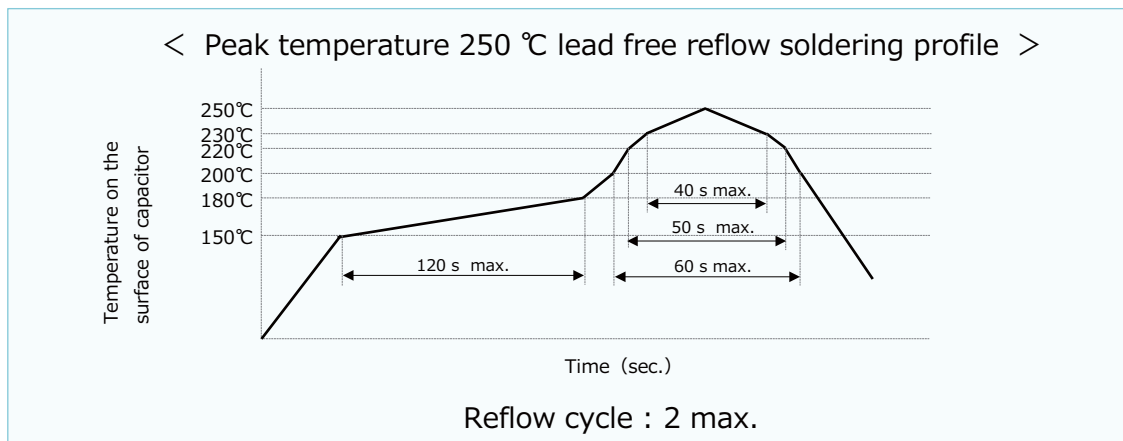

- Soldering with a soldering iron  
 Tip of a soldering iron : 400 °C±10 °C  
 Working time : 5 sec. max.

- Flow soldering

	Temperature	Time	Flow number
Preheating	120 °C or less (ambient temperature)	120 sec. or less	1 time
Soldering condition	260 °C+5 °C or less	10+1 sec. or less	2 times or less <sup>*1</sup>

\*1 : When soldering 2 times, total immersion time should be 10+1 sec. or less.

### Land pattern

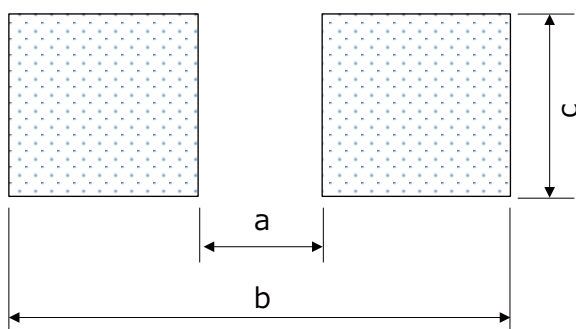

Size code	Unit : mm		
	a	b	c
A5	1.0	6.2	1.6
B45	1.4	7.4	1.6
B6	1.4	7.4	1.6
C5	2.1	9.1	1.6
C55	2.1	9.1	1.6
C6	2.1	9.1	1.6
C8	2.1	9.1	1.6
C10	2.1	9.1	1.6
E7	2.8	11.1	1.9
E10	2.8	11.1	1.9
E12	2.8	11.1	1.9
F8	4.3	13.1	1.9
F12	4.3	13.1	1.9

## Packing specifications

### ◇ SMD type

#### ● Taping

#### 1-1. Carrier tape

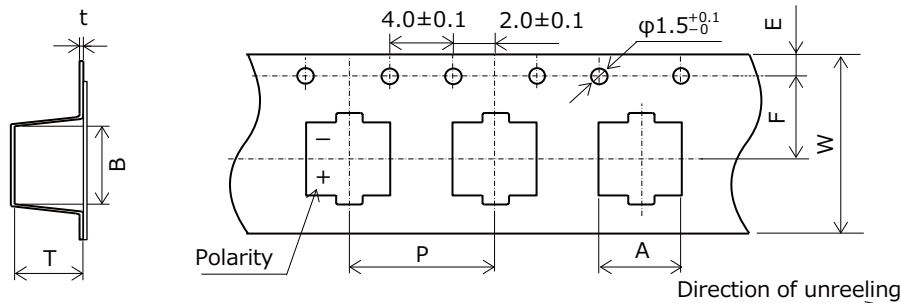

Size code	$A \pm 0.2$	$B \pm 0.2$	$W \pm 0.3$	$F \pm 0.1$	$E \pm 0.1$	$P \pm 0.1$	$t \pm 0.1$	$T \pm 0.2$
A5	4.7	4.7	12.0	5.5	1.75	8.0	0.4	5.8
B45	5.6	5.6	16.0	7.5	1.75	8.0	0.4	4.8
B6	5.6	5.6	16.0	7.5	1.75	8.0	0.4	6.2
C5	6.9	6.9	16.0	7.5	1.75	12.0	0.4	5.3
C55	6.9	6.9	16.0	7.5	1.75	12.0	0.4	6.2
C6	6.9	6.9	16.0	7.5	1.75	12.0	0.4	6.2
C8	7.0	7.0	16.0	7.5	1.75	12.0	0.5	8.2
C10	7.0	7.0	24.0	11.5	1.75	16.0	0.5	10.5
E7	8.6	8.6	24.0	11.5	1.75	12.0	0.4	7.2
E10	8.6	8.6	24.0	11.5	1.75	16.0	0.5	11.0
E12	8.6	8.6	24.0	11.5	1.75	16.0	0.5	12.3
F8	10.7	10.7	24.0	11.5	1.75	16.0	0.4	8.2
F12	10.7	10.7	24.0	11.5	1.75	16.0	0.4	13.0

#### 1-2. Reel

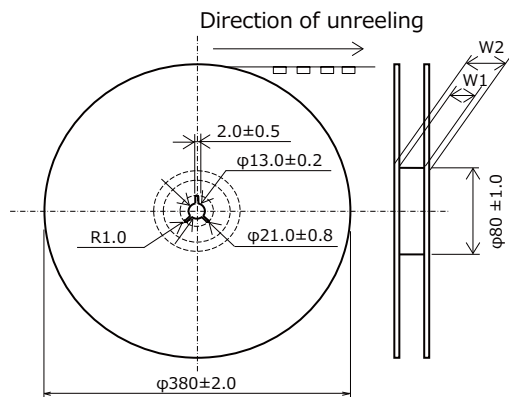

Size code	$W1 \pm 0.5$	$W2 \pm 1.0$
A5	13.0	17.5
B45, B6, C5, C55, C6, C8	17.0	21.5
C10, E7, E10, E12, F8, F12	25.0	29.5

#### ● Minimum packing quantity and weight

Size code	Quantity (pcs./Reel, $\phi 380$ )	Typical weight (g)
A5	2000	700
B45	2500	900
B6	1500	800
C5	1300	800
C55	1000	800
C6	1000	800
C8	900	800
C10	500	700
E7	1000	1100
E10	500	900
E12	400	800
F8	500	1000
F12	400	1000

## Packing specifications

### ◇ Radial lead type

#### ● Lead terminal process

#### 1-1. Applications

※ The following table is a standard specification. Please contact us separately concerning specifications except for that mentioned below.  
 Because of a limit on the length of a model name, the part of process name changes to +S from +TSS, +D from +TS, +3 from +C3,  
 Please contact us for details.

Series	Size cde	Bag-packed product (lead terminal cutting)		Taping
		Not processed	Straight cut	
SEP, SEQP, SEPC	B9, C55, C6, C9, C10, E7, E9, E12	○	+C3	+TSS (+S)
SEPF, SXE, SEPG	E13	○	+C3	+TS (+D)
SEF, SEK	F8, F13	○	+C3	+T

#### 1-2. Lead terminal cutting

Lead terminal cutting code	Process names	Size code (φD)	Dimensions																																	
+C3 (+3)	Straight cut	B9 (φ5)																																		
		C55, C6, C9, C10 (φ6.3)																																		
		E7, E9, E12, E13 (φ8)	<table border="1"> <thead> <tr> <th colspan="5">Unit : mm</th> </tr> <tr> <th></th> <th colspan="4">C3</th> </tr> <tr> <th>L</th> <td colspan="4">3.5</td> </tr> </thead> <tbody> <tr> <th colspan="5">Unit : mm</th> </tr> <tr> <th>Size code</th> <th>B9</th> <th>C55, C6, C9, C10</th> <th>E7, E9, E12, E13</th> <th>F8, F13</th> </tr> <tr> <th>F size</th> <td>2.0</td> <td>2.5</td> <td>3.5</td> <td>5.0</td> </tr> </tbody> </table>				Unit : mm						C3				L	3.5				Unit : mm					Size code	B9	C55, C6, C9, C10	E7, E9, E12, E13	F8, F13	F size	2.0	2.5	3.5	5.0
Unit : mm																																				
	C3																																			
L	3.5																																			
Unit : mm																																				
Size code	B9	C55, C6, C9, C10	E7, E9, E12, E13	F8, F13																																
F size	2.0	2.5	3.5	5.0																																
		F8, F13 (φ10)																																		

#### 1-3. Lead terminal taping

Taping code	F size	Size code (φD)	Taping
+T	F=5.0 mm	F8, F13 (φ10)	
+TS (+D)	F=3.5 mm	E13 (φ8)	
+TSS (+S)	F=2.0 mm F=2.5 mm F=3.5 mm	B9 (φ5) C55, C6, C9, C10 (φ6.3) E7, E9, E12 (φ8)	

Code	F <sup>+0.8</sup> <sub>-0.2</sub>	P±1.0	P <sub>0</sub> ±0.2	P <sub>1</sub> ±0.5	P <sub>2</sub> ±1.0	Δh±1.0	W±0.5	W <sub>0</sub> (min.)	W <sub>1</sub> ±0.5
+T φ10	5.0	12.7	12.7	3.85	6.35	0	18.0	9.5	9.0
+TS(+D) φ8	3.5	12.7	12.7	4.60	6.35	0	18.0	9.5	9.0
+TSS φ5	2.0	12.7	12.7	5.35	6.35	0	18.0	9.5	9.0
(+S) φ6.3	2.5	12.7	12.7	5.10	6.35	0	18.0	9.5	9.0
φ8	3.5	12.7	12.7	4.60	6.35	0	18.0	9.5	9.0

Code	W <sub>2</sub> (max.)	H±0.75	φD <sub>0</sub> ±0.2	t±0.3	ℓ (max.)	L (max.)
+T φ10	2.5	18.5	4.0	0.6	0	11.0
+TS(+D) φ8	2.5	17.5	4.0	0.6	0	11.0
+TSS φ5	2.5	17.5	4.0	0.6	0	11.0
(+S) φ6.3	2.5	17.5	4.0	0.6	0	11.0
φ8	2.5	17.5	4.0	0.6	0	11.0

### Packing specifications

- Minimum packing quantity and weight

Size code	Case size	Processed type discrete lead terminals		Zig-zag pack taping type	
		Quantity (pcs./Bag)	Typical weight (g)	Quantity (pcs./Bag)	Typical weight (g)
B9	φ5	500	180	2000	1000
C55	φ6.3	500	150	1500	650
C6	φ6.3	500	160	1500	700
C9	φ6.3	500	240	1500	1000
C10	φ6.3	500	*	1500	*
E7	φ8	200	110	1000	820
E9	φ8	200	130	1000	900
E12	φ8	200	200	1000	980
E13	φ8	200	160	1000	1060
F8	φ10	200	180	500	890
F13	φ10	200	280	500	940

\* Please contact us.

## Surface Mount Type



Series : **SVF**



### Features

- High voltage (50 V.DC max.)
- Large capacitance (1000  $\mu$ F max.)
- 125 °C 1000 h
- RoHS compliance, Halogen free

### Specifications

Size code	B6	C6	E7	E12	F12
Category temperature range	-55 °C to +125 °C				
Rated voltage range	16 V.DC to 25 V.DC		16 V.DC to 50 V.DC		
Rated capacitance range	27 $\mu$ F to 82 $\mu$ F	10 $\mu$ F to 180 $\mu$ F	18 $\mu$ F to 270 $\mu$ F	39 $\mu$ F to 560 $\mu$ F	68 $\mu$ F to 1000 $\mu$ F
Capacitance tolerance	$\pm$ 20 % (120 Hz / + 20 °C)				
Leakage current	Please see the attached characteristics list				
Dissipation factor (tan $\delta$ )	Please see the attached characteristics list				
Endurance	+125 °C, 1000 h, rated voltage applied				
	Capacitance change	Within $\pm$ 20 % of the initial value			
	tan $\delta$	$\leq$ 200 % of the initial limit			
	DC leakage current	Within the initial limit			
Damp heat (Steady State)	+60 °C, 90 % to 95 %, 1000 h, No-applied voltage				
	Capacitance change	Within $\pm$ 20 % of the initial value			
	tan $\delta$	$\leq$ 150 % of the initial limit			
	DC leakage current	Within the initial limit (after voltage processing)			

### Marking

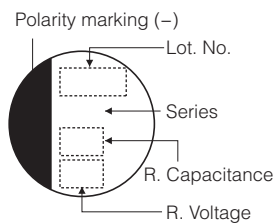

### Dimensions (not to scale)

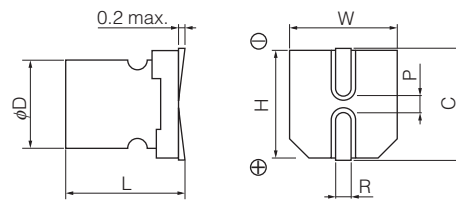

Unit : mm

Size code	$\phi D \pm 0.5$	$L \begin{smallmatrix} +0.1 \\ -0.4 \end{smallmatrix}$	$W \pm 0.2$	$H \pm 0.2$	$C \pm 0.2$	R	$P \pm 0.2$
B6	5.0	5.9	5.3	5.3	6.0	0.6 to 0.8	1.4
C6	6.3	5.9	6.6	6.6	7.3	0.6 to 0.8	2.1
E7	8.0	6.9	8.3	8.3	9.0	0.6 to 0.8	3.2
E12	8.0	11.9	8.3	8.3	9.0	0.8 to 1.1	3.2
F12	10.0	12.6	10.3	10.3	11.0	0.8 to 1.1	4.6

\* Externals of figure are the reference.



## Characteristics list

Series	Rated voltage (V.DC)	Rated capacitance (μF)	Case size (mm)		Size code	Specifications					Standard (Reel size : φ380)	
			φD	L		Ripple current (mAr.m.s.) <sup>*1</sup>	Allowable <sup>*1</sup> ripple current (mAr.m.s.)	ESR <sup>*2</sup> (mΩ max.)	tan δ <sup>*3</sup>	LC <sup>*4</sup> (μA)	Part number	Min. Packaging Q'ty (pcs)
SVF	16	82	5.0	5.9	B6	940	3000	27	0.12	262	16SVF82M	1500
		180	6.3	5.9	C6	1040	3300	22	0.12	576	16SVF180M	1000
		270	8.0	6.9	E7	1040	3300	22	0.12	864	16SVF270M	1000
		560	8.0	11.9	E12	1560	4950	14	0.12	1792	16SVF560M	400
		1000	10.0	12.6	F12	1700	5400	12	0.12	3200	16SVF1000M	400
	20	56	5.0	5.9	B6	880	2800	30	0.12	224	20SVF56M	1500
		120	6.3	5.9	C6	1010	3200	25	0.12	480	20SVF120M	1000
		180	8.0	6.9	E7	1010	3200	25	0.12	720	20SVF180M	1000
		390	8.0	11.9	E12	1560	4950	14	0.12	1560	20SVF390M	400
		560	10.0	12.6	F12	1700	5400	12	0.12	2240	20SVF560M	400
	25	27	5.0	5.9	B6	770	2450	40	0.12	135	25SVF27M	1500
		47	6.3	5.9	C6	880	2800	30	0.12	235	25SVF47M	1000
		56	6.3	5.9		880	2800	30	0.12	280	25SVF56M	1000
		82	8.0	6.9	E7	940	3000	28	0.12	410	25SVF82M	1000
		100	8.0	6.9		1010	3200	24	0.12	500	25SVF100M	1000
		180	8.0	11.9	E12	1470	4650	16	0.12	900	25SVF180M	400
		330	10.0	12.6	F12	1580	5000	14	0.12	1650	25SVF330M	400
	35	22	6.3	5.9	C6	820	2600	35	0.12	154	35SVF22M	1000
		39	8.0	6.9	E7	880	2800	30	0.12	273	35SVF39M	1000
		82	8.0	11.9	E12	1260	4000	20	0.12	574	35SVF82M	400
		120	10.0	12.6	F12	1390	4400	18	0.12	840	35SVF120M	400
	50	10	6.3	5.9	C6	790	2500	40	0.12	100	50SVF10M	1000
		18	8.0	6.9	E7	850	2700	35	0.12	180	50SVF18M	1000
		39	8.0	11.9	E12	1200	3800	25	0.12	390	50SVF39M	400
68		10.0	12.6	F12	1350	4300	20	0.12	680	50SVF68M	400	

\*1 Ripple current (100 kHz/ +105 °C < Tx ≤ +125 °C) /Allowable ripple current (100 kHz/ Tx ≤ +105 °C), \*2 ESR (100 kHz to 300 kHz/+20 °C)

\*3 tan δ (120 Hz/+20 °C) \*4 After 2 minutes

◆ Please refer to each page in this catalog for "Reflow conditions" and "Taping specifications".

## Frequency correction factor for ripple current

Frequency	120 Hz ≤ f < 1 kHz	1 kHz ≤ f < 10 kHz	10 kHz ≤ f < 100 kHz	100 kHz ≤ f < 500 kHz
Coefficient	0.05	0.3	0.7	1

## Surface Mount Type

Series: **SVPK**



**OS-CON**

**UPGRADE**

### Features

- High voltage (50 V.DC max.)
- 125 °C 1000 h
- RoHS compliance, Halogen free

### Specifications

Size code	B6	C6	E7	E12	F12
Category temp. range	-55 °C to +125 °C				
Rated voltage range	16 V.DC to 50 V.DC				
Nominal cap.range	10 μF to 100 μF	22 μF to 220 μF	33 μF to 330 μF	68 μF to 680 μF	120 μF to 1200 μF
Capacitance tolerance	±20 % (120 Hz / +20 °C)				
DC leakage current	Please see the attached characteristics list				
Dissipation factor (tan δ)	Please see the attached characteristics list				
Endurance	+125 °C, 1000 h, rated voltage applied				
	Capacitance change	Within ±20 % of the initial value			
	Dissipation factor (tanδ)	≤ 200 % of the initial limit			
	DC leakage current	Within the initial limit			
	+60 °C, 90 % to 95 %, 1000 h, No-applied voltage				
	Capacitance change	Within ±20 % of the initial value			
	Dissipation factor (tanδ)	≤ 150 % of the initial limit			
	DC leakage current				Within the initial limit (after voltage processing)

### Marking

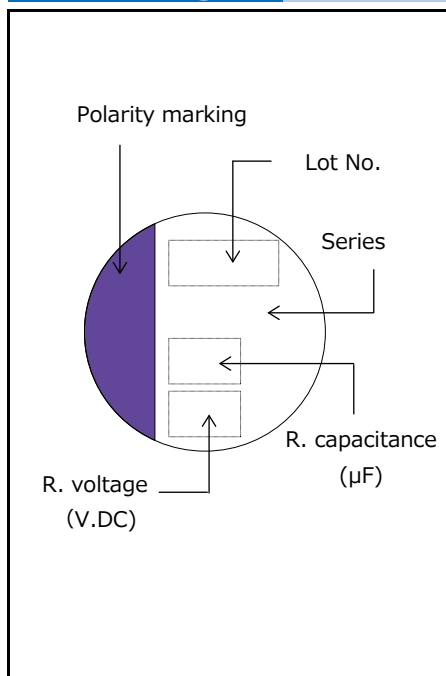

### Dimensions (not to scale)

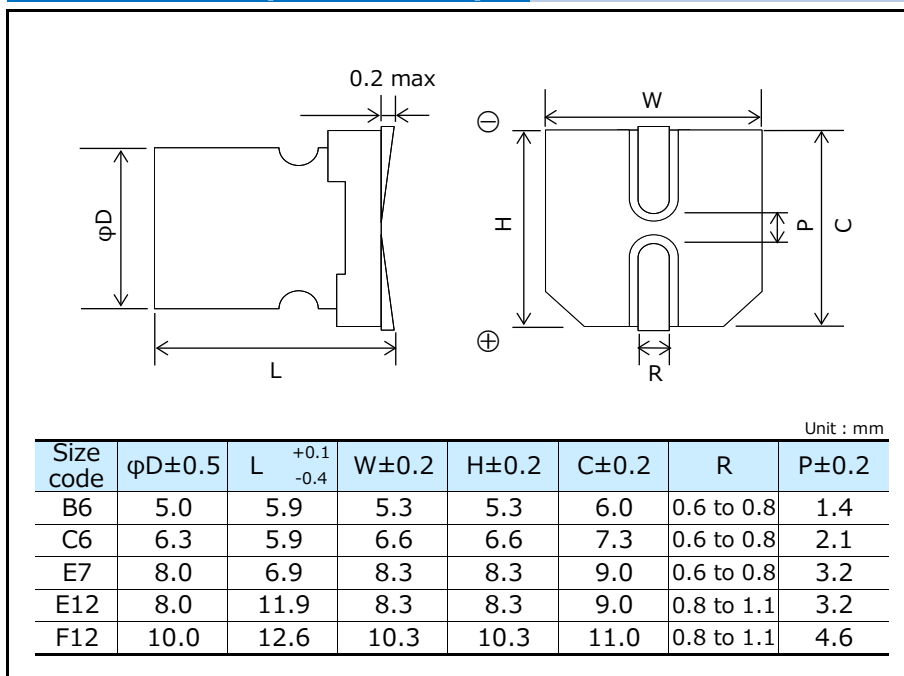

# Panasonic Conductive Polymer Aluminum Solid Capacitors

## Characteristics list

Rated volt. (V.DC)	Rated cap. (±20 %) (μF)	Case size (mm)		Size code	Specifications					Standard (Reel size : φ380)	
		φD	L		Ripple current* <sup>1</sup> (mA r.m.s.)	Allowable ripple current* <sup>1</sup> (mA r.m.s.)	ESR* <sup>2</sup> (mΩ)	tan δ* <sup>3</sup>	LC* <sup>4</sup> (μA)	Part number	Min. Packaging Qty (pcs)
<b>NEW</b> 16	100	5.0	5.9	B6	940	3000	27	0.12	320	16SVPK100M	1500
	220	6.3	5.9	C6	1040	3300	22	0.12	704	16SVPK220M	1000
	330	8.0	6.9	E7	1040	3300	22	0.12	1056	16SVPK330M	1000
	680	8.0	11.9	E12	1560	4950	14	0.12	2176	16SVPK680M	400
	1200	10.0	12.6	F12	1700	5400	12	0.12	3840	16SVPK1200M	400
<b>NEW</b> 20	68	5.0	5.9	B6	880	2800	30	0.12	272	20SVPK68M	1500
	150	6.3	5.9	C6	1010	3200	25	0.12	600	20SVPK150M	1000
	220	8.0	6.9	E7	1010	3200	25	0.12	880	20SVPK220M	1000
	470	8.0	11.9	E12	1560	4950	14	0.12	1880	20SVPK470M	400
	680	10.0	12.6	F12	1700	5400	12	0.12	2720	20SVPK680M	400
25	33	5.0	5.9	B6	820	2600	35	0.12	165	25SVPK33M	1500
	82	6.3	5.9	C6	960	3060	25	0.12	410	25SVPK82M	1000
	90	6.3	5.9	C6	960	3060	25	0.12	450	25SVPK90M	1000
	120	8.0	6.9	E7	1010	3200	24	0.12	600	25SVPK120M	1000
	270	8.0	11.9	E12	1470	4650	16	0.12	1350	25SVPK270M	400
	470	10.0	12.6	F12	1590	5000	14	0.12	2350	25SVPK470M	400
35	22	5.0	5.9	B6	820	2600	35	0.12	154	35SVPK22M	1500
	47	6.3	5.9	C6	930	2950	27	0.12	329	35SVPK47M	1000
	82	8.0	6.9	E7	960	3060	25	0.12	574	35SVPK82M	1000
	180	8.0	11.9	E12	1260	4000	20	0.12	1260	35SVPK180M	400
	330	10.0	12.6	F12	1390	4400	18	0.12	2310	35SVPK330M	400
50	10	5.0	5.9	B6	550	1750	80	0.12	100	50SVPK10M	1500
	22	6.3	5.9	C6	820	2600	35	0.12	220	50SVPK22M	1000
	33	8.0	6.9	E7	850	2700	35	0.12	330	50SVPK33M	1000
	68	8.0	11.9	E12	1200	3800	25	0.12	680	50SVPK68M	400
	120	10.0	12.6	F12	1350	4300	20	0.12	1200	50SVPK120M	400

\*1: Ripple current (100 kHz / +105 °C < Tx ≤ +125 °C) / Allowable ripple current (100 kHz / Tx ≤ +105 °C)

\*2: ESR (100 kHz to 300 kHz / +20 °C)

\*3: tan δ (120 Hz / +20 °C)

\*4: After 2 minutes

• Please refer to each page in this catalog for "Reflow conditions" and "Taping specifications".

## Frequency correction factor for ripple current

Frequency(f)	120 Hz ≤ f < 1 kHz	1 kHz ≤ f < 10 kHz	10 kHz ≤ f < 100 kHz	100 kHz ≤ f < 500 kHz
Coefficient	0.05	0.3	0.7	1

## Surface Mount Type

Series: **SXV**



**OS-CON**

**UPGRADE**

### Features

- Super high voltage (100 V.DC max.)
- RoHS compliance, Halogen free

### Specifications

Size code	E7	F8	E12	F12
Category temp. range	-55 °C to +125 °C			
Rated voltage range	63 V.DC to 100 V.DC			
Nominal cap.range	6.8 μF to 18 μF	15 μF to 39 μF	15 μF to 56 μF	18 μF to 100 μF
Capacitance tolerance	±20 % (120 Hz / +20 °C)			
DC leakage current	Please see the attached characteristics list			
Dissipation factor (tan δ)	Please see the attached characteristics list			
Endurance	+125 °C, 1000 h, rated voltage applied			
	Capacitance change	Within ±20 % of the initial value		
	Dissipation factor (tanδ)	≤ 200 % of the initial limit		
	DC leakage current	Within the initial limit		
	+60 °C, 90 % to 95 %, 1000 h, No-applied voltage			
	Capacitance change	Within ±20 % of the initial value		
	Dissipation factor (tanδ)	≤ 150 % of the initial limit		
	DC leakage current	Within the initial limit (after voltage processing)		

### Marking

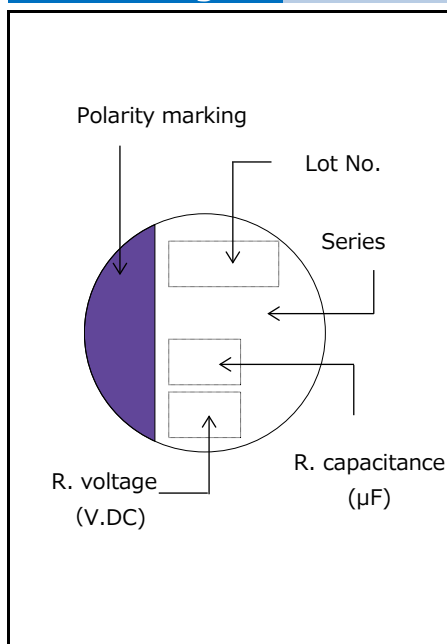

### Dimensions (not to scale)

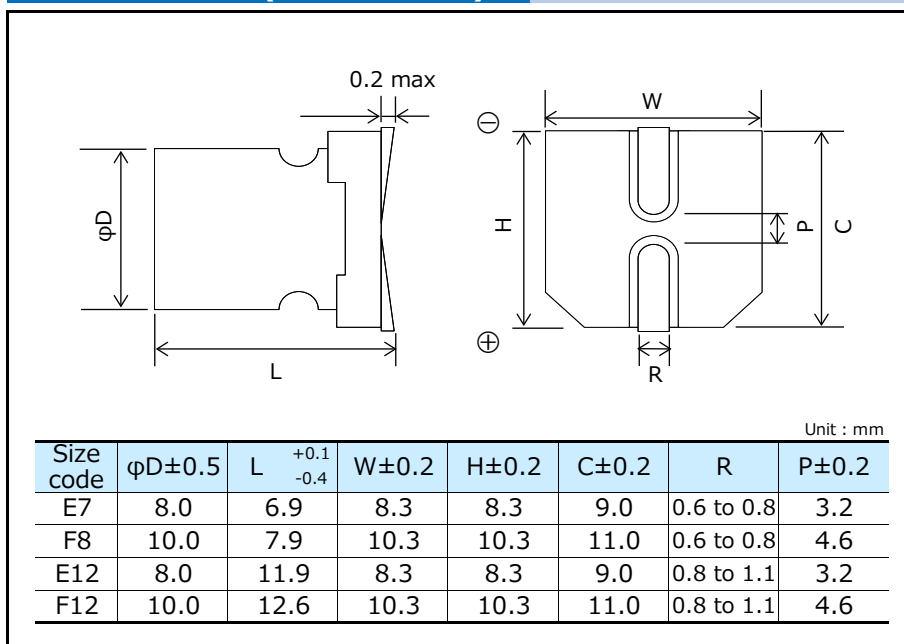

# Panasonic Conductive Polymer Aluminum Solid Capacitors

## Characteristics list

Rated volt. (V.DC)	Rated cap. ( $\pm 20\%$ ) ( $\mu\text{F}$ )	Case size (mm)		Size code	Specifications					Standard (Reel size : $\phi 380$ )	
		$\phi\text{D}$	L		Ripple current* <sup>1</sup> (mA r.m.s.)	Allowable ripple current* <sup>1</sup> (mA r.m.s.)	ESR* <sup>2</sup> ( $\text{m}\Omega$ )	$\tan \delta$ * <sup>3</sup>	LC* <sup>4</sup> ( $\mu\text{A}$ )	Part number	Min. Packaging Q'ty (pcs)
63	18	8.0	6.9	E7	340	1100	60	0.12	56	63SXV18M	1000
	33	8.0	11.9	E12	930	2950	25	0.12	104	63SXV33M	400
	39	8.0	11.9	E12	930	2950	25	0.12	122	63SXV39M	400
		10.0	7.9	F8	690	2190	50	0.12	122	63SXV39MX	500
	<b>NEW</b> 56	8.0	11.9	E12	930	2950	25	0.12	176	63SXV56M	400
	68	10.0	12.6	F12	1030	3280	25	0.12	214	63SXV68M	400
<b>NEW</b> 100	10.0	12.6	F12	1030	3280	25	0.12	315	63SXV100M	400	
80	12	8.0	6.9	E7	340	1100	60	0.12	48	80SXV12M	1000
	27	8.0	11.9	E12	780	2490	35	0.12	108	80SXV27M	400
		10.0	7.9	F8	660	2080	55	0.12	108	80SXV27MX	500
	<b>NEW</b> 33	8.0	11.9	E12	780	2490	35	0.12	132	80SXV33M	400
	47	10.0	12.6	F12	980	3100	28	0.12	980	80SXV47M	400
<b>NEW</b> 56	10.0	12.6	F12	980	3100	28	0.12	224	80SXV56M	400	
100	6.8	8.0	6.9	E7	340	1100	60	0.12	34	100SXV6R8M	1000
	15	10.0	7.9	F8	630	2000	60	0.12	75	100SXV15MX	500
		8.0	11.9	E12	730	2350	40	0.12	75	100SXV15M	400
	18	10.0	12.6	F12	940	3000	30	0.12	90	100SXV18M	400
		<b>NEW</b> 18	8.0	11.9	E12	730	2350	40	0.12	90	100SXV18MX
	22	10.0	12.6	F12	940	3000	30	0.12	110	100SXV22M	400
<b>NEW</b> 27	10.0	12.6	F12	940	3000	30	0.12	135	100SXV27M	400	

\*1: Ripple current (100 kHz /  $+105\text{ }^\circ\text{C} < T_x \leq +125\text{ }^\circ\text{C}$ ) / Allowable ripple current (100 kHz /  $T_x \leq +105\text{ }^\circ\text{C}$ )

\*2: ESR (100 kHz to 300 kHz /  $+20\text{ }^\circ\text{C}$ )

\*3:  $\tan \delta$  (120 Hz /  $+20\text{ }^\circ\text{C}$ )

\*4: After 2 minutes

• Please refer to each page in this catalog for "Reflow conditions" and "Taping specifications".

## Frequency correction factor for ripple current

Frequency(f)	$120\text{ Hz} \leq f < 1\text{ kHz}$	$1\text{ kHz} \leq f < 10\text{ kHz}$	$10\text{ kHz} \leq f < 100\text{ kHz}$	$100\text{ kHz} \leq f < 500\text{ kHz}$
Coefficient	0.05	0.3	0.7	1

## Surface Mount Type

# OS-CON

### Series : SVPG



### Features

- Low profile (Height 4.5 mm max.)
- Low ESR (8 mΩ to 30 mΩ)
- RoHS compliance, Halogen free

### Specifications

Size code	B45	C8	C10
Category temperature range	-55 °C to +105 °C		
Rated voltage range	16 V.DC to 25 V.DC	16 V.DC	
Rated capacitance range	15 μF to 47 μF	270 μF	
Capacitance tolerance	±20 % (120 Hz / + 20 °C)		
Leakage current	Please see the attached characteristics list		
Dissipation factor (tan δ)	Please see the attached characteristics list		
Endurance	+105 °C, 5000 h, rated voltage applied		
	Capacitance change	Within ±20 % of the initial value	
	tan δ	≤ 150 % of the initial limit	
	DC leakage current	Within the initial limit	
Damp heat (Steady State)	+60 °C, 90 % to 95 %, 1000 h, No-applied voltage		
	Capacitance change	Within ±20 % of the initial value	
	tan δ	≤ 150 % of the initial limit	
	DC leakage current	Within the initial limit (after voltage processing)	

### Marking

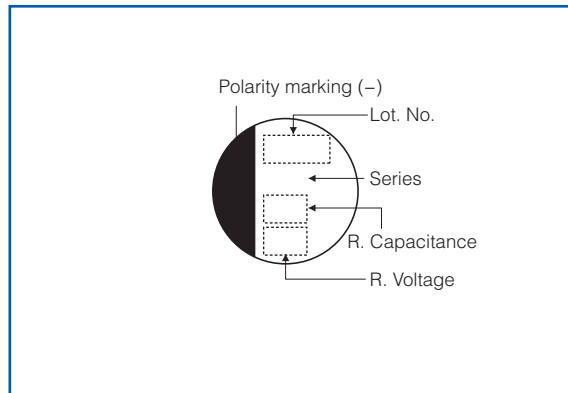

### Dimensions (not to scale)

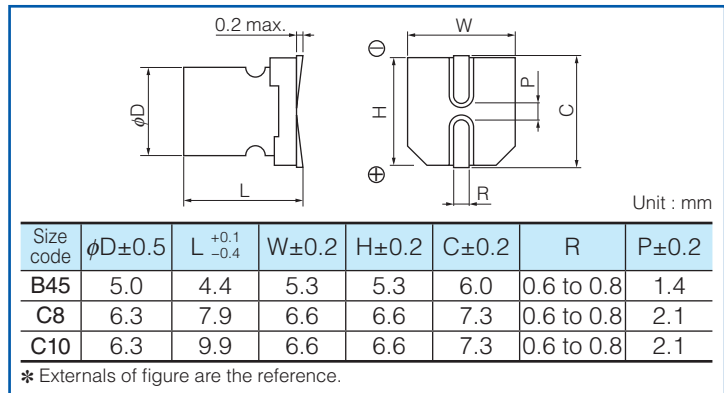

### Characteristics list

Series	Rated voltage (V.DC)	Rated capacitance (μF)	Case size (mm)		Size code	Specifications				Standard (Reel size : ϕ380)	
			ϕD	L		Ripple current* <sup>1</sup> (mA.r.m.s.)	ESR* <sup>2</sup> (mΩ max.)	tan δ* <sup>3</sup>	LC* <sup>4</sup> (μA)	Part number	Min. Packaging Qty (pcs)
SVPG	16	47	5.0	4.4	B45	3200	25	0.12	150	16SVPG47M	2500
		270 <b>NEW</b>	6.3	7.9	C8	5080	10	0.12	864	16SVPG270MX	900
			6.3	9.9	C10	5800	8	0.12	864	16SVPG270M	500
	20	33	5.0	4.4	B45	3000	27	0.12	132	20SVPG33M	2500
	25	15	5.0	4.4		2800	30	0.12	75	25SVPG15M	2500

\*1 Ripple current (100 kHz/ +105 °C) \*2 ESR (100 kHz to 300 kHz/+20 °C) \*3 tan δ (120 Hz/+20 °C) \*4 After 2 minutes  
 ◆ Please refer to each page in this catalog for "Reflow conditions" and "Taping specifications".

### Frequency correction factor for ripple current

Frequency	120 Hz ≤ f < 1 kHz	1 kHz ≤ f < 10 kHz	10 kHz ≤ f < 100 kHz	100 kHz ≤ f < 500 kHz
Coefficient	0.05	0.3	0.7	1

## Surface Mount Type



Series : **SVPF**



### Features

- High voltage (50 V.DC max.)
- Large capacitance (1000  $\mu$ F max.)
- 105 °C 5000 h
- RoHS compliance, Halogen free

### Specifications

Size code	B6	C6	E7	E10	E12	F12
Category temperature range	-55 °C to +105 °C					
Rated voltage range	16 V.DC to 25 V.DC	16 V.DC to 50 V.DC		16 V.DC	16 V.DC to 50 V.DC	
Rated capacitance range	27 $\mu$ F to 82 $\mu$ F	10 $\mu$ F to 180 $\mu$ F	18 $\mu$ F to 270 $\mu$ F	560 $\mu$ F	39 $\mu$ F to 560 $\mu$ F	68 $\mu$ F to 1000 $\mu$ F
Capacitance tolerance	$\pm$ 20 % (120 Hz / + 20 °C)					
Leakage current	Please see the attached characteristics list					
Dissipation factor (tan $\delta$ )	Please see the attached characteristics list					
Endurance	+105 °C, 5000 h, rated voltage applied					
	Capacitance change	Within $\pm$ 20 % of the initial value				
	tan $\delta$	$\leq$ 150 % of the initial limit				
	DC leakage current	Within the initial limit				
Damp heat (Steady State)	+60 °C, 90 % to 95 %, 1000 h, No-applied voltage					
	Capacitance change	Within $\pm$ 20 % of the initial value				
	tan $\delta$	$\leq$ 150 % of the initial limit				
	DC leakage current	Within the initial limit (after voltage processing)				

### Marking

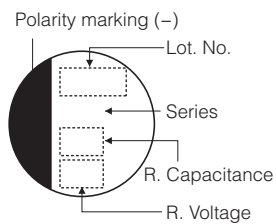

### Dimensions (not to scale)

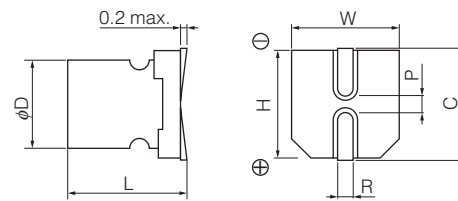

Unit : mm

Size code	$\phi$ D $\pm$ 0.5	L $^{+0.1}_{-0.4}$	W $\pm$ 0.2	H $\pm$ 0.2	C $\pm$ 0.2	R	P $\pm$ 0.2
B6	5.0	5.9	5.3	5.3	6.0	0.6 to 0.8	1.4
C6	6.3	5.9	6.6	6.6	7.3	0.6 to 0.8	2.1
E7	8.0	6.9	8.3	8.3	9.0	0.6 to 0.8	3.2
E10	8.0	10.0 ( $\pm$ 0.5)	8.3	8.3	9.0	0.8 to 1.1	3.2
E12	8.0	11.9	8.3	8.3	9.0	0.8 to 1.1	3.2
F12	10.0	12.6	10.3	10.3	11.0	0.8 to 1.1	4.6

\* Externals of figure are the reference.

## Characteristics list

Series	Rated voltage (V.DC)	Rated capacitance (μF)	Case size (mm)		Size code	Specifications				Standard (Reel size : φ380)	
			φD	L		Ripple current* <sup>1</sup> (mA r.m.s.)	ESR* <sup>2</sup> (mΩ max.)	tan δ* <sup>3</sup>	LC* <sup>4</sup> (μA)	Part number	Min. Packaging Qty (pcs)
SVPF	16 <small>NEW</small>	82	5.0	5.9	B6	3000	27	0.12	262	16SVPF82M	1500
		180	6.3	5.9	C6	3300	22	0.12	576	16SVPF180M	1000
		270	8.0	6.9	E7	3300	22	0.12	864	16SVPF270M	1000
		560	8.0	10.0	E10	3900	18	0.12	1792	16SVPF560MX	500
			8.0	11.9	E12	4950	14	0.12	1792	16SVPF560M	400
		1000	10.0	12.6	F12	5400	12	0.12	3200	16SVPF1000M	400
	20	56	5.0	5.9	B6	2800	30	0.12	224	20SVPF56MX	1500
		120	6.3	5.9	C6	3200	25	0.12	480	20SVPF120M	1000
		180	8.0	6.9	E7	3200	25	0.12	720	20SVPF180M	1000
		390	8.0	11.9	E12	4950	14	0.12	1560	20SVPF390M	400
		560	10.0	12.6	F12	5400	12	0.12	2240	20SVPF560M	400
	25	27	5.0	5.9	B6	2450	40	0.12	135	25SVPF27MX	1500
		47	6.3	5.9	C6	2800	30	0.12	235	25SVPF47M	1000
		56	6.3	5.9		2800	30	0.12	280	25SVPF56M	1000
		82	8.0	6.9	E7	3000	28	0.12	410	25SVPF82M	1000
		100	8.0	6.9		3200	24	0.12	500	25SVPF100M	1000
		180	8.0	11.9	E12	4650	16	0.12	900	25SVPF180M	400
		330	10.0	12.6	F12	5000	14	0.12	1650	25SVPF330M	400
	35	22	6.3	5.9	C6	2600	35	0.12	154	35SVPF22M	1000
		39	8.0	6.9	E7	2800	30	0.12	273	35SVPF39M	1000
		82	8.0	11.9	E12	4000	20	0.12	574	35SVPF82M	400
		120	10.0	12.6	F12	4400	18	0.12	840	35SVPF120M	400
	50	10	6.3	5.9	C6	2500	40	0.12	100	50SVPF10M	1000
		18	8.0	6.9	E7	2700	35	0.12	180	50SVPF18M	1000
		39	8.0	11.9	E12	3800	25	0.12	390	50SVPF39M	400
		68	10.0	12.6	F12	4300	20	0.12	680	50SVPF68M	400

\*1 Ripple current (100 kHz/ +105 °C), \*2 ESR (100 kHz to 300 kHz/+20 °C) \*3 tan δ (120 Hz/+20 °C) \*4 After 2 minutes  
 ◆ Please refer to each page in this catalog for "Reflow conditions" and "Taping specifications".

## Frequency correction factor for ripple current

Frequency	120 Hz ≤ f < 1 kHz	1 kHz ≤ f < 10 kHz	10 kHz ≤ f < 100 kHz	100 kHz ≤ f < 500 kHz
Coefficient	0.05	0.3	0.7	1



## Surface Mount Type



Series : **SVPA**



### Features

- Low ESR (18 mΩ max.)
- High ripple (4240 mA.r.m.s.)
- RoHS compliance, Halogen free

### Specifications

Size code	B6	C6	E7	F8
Category temperature range	-55 °C to +105 °C			
Rated voltage range	2.5 V.DC to 20 V.DC			2.5 V.DC to 16 V.DC
Rated capacitance range	10 μF to 82 μF	22 μF to 180 μF	47 μF to 330 μF	180 μF to 820 μF
Capacitance tolerance	±20 % (120 Hz / + 20 °C)			
Leakage current	Please see the attached characteristics list			
Dissipation factor (tan δ)	Please see the attached characteristics list			
Endurance	+105 °C, 2000 h, rated voltage applied			
	Capacitance change	Within ±20 % of the initial value		
	tan δ	≤ 150 % of the initial limit		
Damp heat (Steady State)	+60 °C, 90 % to 95 %, 1000 h, No-applied voltage			
	Capacitance change	Within ±20 % of the initial value		
	tan δ	≤ 150 % of the initial limit		
	DC leakage current	Within the initial limit (after voltage processing)		

### Marking

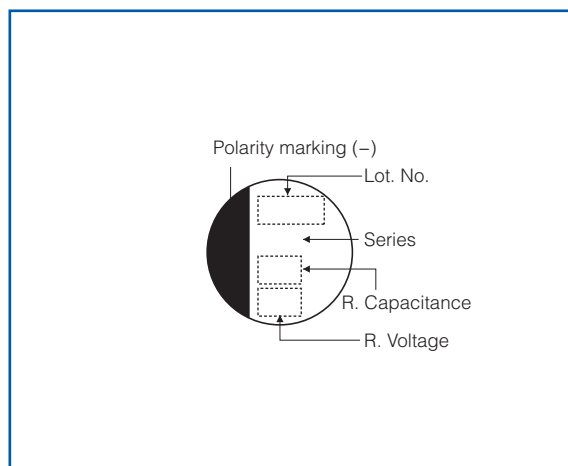

### Dimensions (not to scale)

Unit : mm

Size code	φD±0.5	L <sup>+0.1</sup> / <sub>-0.4</sub>	W±0.2	H±0.2	C±0.2	R	P±0.2
B6	5.0	5.9	5.3	5.3	6.0	0.6 to 0.8	1.4
C6	6.3	5.9	6.6	6.6	7.3	0.6 to 0.8	2.1
E7	8.0	6.9	8.3	8.3	9.0	0.6 to 0.8	3.2
F8	10.0	7.9	10.3	10.3	11.0	0.6 to 0.8	4.6

\* Externals of figure are the reference.

## Characteristics list

Series	Rated voltage (V.DC)	Rated capacitance (μF)	Case size (mm)		Size code	Specifications				Standard (Reel size : φ380)	
			φD	L		Ripple * <sup>1</sup> current (mA r.m.s.)	ESR * <sup>2</sup> (mΩ max.)	tan δ * <sup>3</sup>	LC * <sup>4</sup> (μA)	Part number	Min. Packaging Qty (pcs)
SVPA	2.5	82	5.0	5.9	B6	1970	30	0.12	300	2R5SVPA82MAA	1500
		180	6.3	5.9	C6	2690	20	0.12	300	2R5SVPA180MAA	1000
		330	8.0	6.9	E7	3370	20	0.12	500	2R5SVPA330MAA	1000
		820	10.0	7.9	F8	4240	19	0.12	500	2R5SVPA820M	500
	4.0	68	5.0	5.9	B6	1970	30	0.12	300	4SVPA68MAA	1500
		150	6.3	5.9	C6	2570	22	0.12	300	4SVPA150MAA	1000
		270	8.0	6.9	E7	3220	22	0.12	500	4SVPA270MAA	1000
		680	10.0	7.9	F8	4130	20	0.12	544	4SVPA680M	500
	6.3	47	5.0	5.9	B6	1970	30	0.12	300	6SVPA47MAA	1500
		120	6.3	5.9	C6	2570	22	0.12	300	6SVPA120MAA	1000
		220	8.0	6.9	E7	3220	22	0.12	500	6SVPA220MAA	1000
		470	10.0	7.9	F8	4130	20	0.12	592	6SVPA470M	500
	10	68	6.3	5.9	C6	2200	30	0.12	300	10SVPA68MAA	1000
		150	8.0	6.9	E7	2760	30	0.12	500	10SVPA150MAA	1000
		330	10.0	7.9	F8	3770	24	0.12	660	10SVPA330M	500
	16	39	6.3	5.9	C6	2040	35	0.12	300	16SVPA39MAA	1000
			6.3	5.9		2460	24	0.12	300	16SVPA39MAAY	1000
		82	8.0	6.9	E7	2760	30	0.12	262	16SVPA82MAA	1000
		180	10.0	7.9	F8	3430	29	0.12	576	16SVPA180M	500
	20	10	5.0	5.9	B6	1700	40	0.12	80	20SVPA10M	1500
22		6.3	5.9	C6	2040	35	0.12	88	20SVPA22M	1000	
47		8.0	6.9	E7	2630	33	0.12	188	20SVPA47M	1000	

\*1 Ripple current (100 kHz/ +105 °C), \*2 ESR (100 kHz/+20 °C) \*3 tan δ (120 Hz/+20 °C) \*4 After 2 minutes

◆ Please refer to each page in this catalog for "Reflow conditions" and "Taping specifications".

## Frequency correction factor for ripple current

Frequency	120 Hz ≤ f < 1 kHz	1 kHz ≤ f < 10 kHz	10 kHz ≤ f < 100 kHz	100 kHz ≤ f < 500 kHz
Coefficient	0.05	0.3	0.7	1

## Surface Mount Type



Series : **SVPB**



### Features

- Low profile (Height 5 mm max.)
- RoHS compliance, Halogen free

### Specifications

Size code	C5	C55
Category temperature range	-55 °C to +105 °C	
Rated voltage range	2.5 V.DC to 20 V.DC	20 V.DC
Rated capacitance range	15 μF to 120 μF	22 μF
Capacitance tolerance	±20 % (120 Hz / + 20 °C)	
Leakage current	Please see the attached characteristics list	
Dissipation factor (tan δ)	Please see the attached characteristics list	
Endurance	+105 °C, 1000 h, rated voltage applied	
	Capacitance change	Within ±20 % of the initial value (±30 % for C5 size)
	tan δ	≤ 150 % of the initial limit
	DC leakage current	Within the initial limit
Damp heat (Steady State)	+60 °C, 90 % to 95 %, 1000 h, No-applied voltage	
	Capacitance change	Within ±20 % of the initial value
	tan δ	≤ 150 % of the initial limit
	DC leakage current	Within the initial limit (after voltage processing)

### Marking

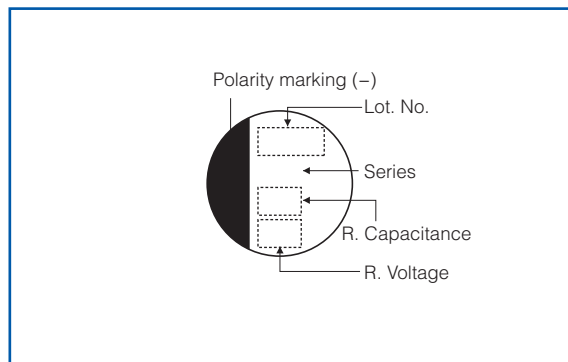

### Dimensions (not to scale)

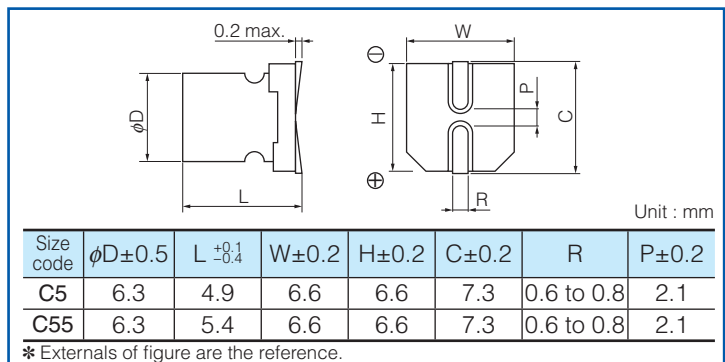

### Characteristics list

Series	Rated voltage (V.DC)	Rated capacitance (μF)	Case size (mm)		Size code	Specifications				Standard (Reel size : φ380)	
			φD	L		Ripple* <sup>1</sup> current (mAr.m.s.)	ESR* <sup>2</sup> (mΩ max.)	tan δ* <sup>3</sup>	LC* <sup>4</sup> (μA)	Part number	Min. Packaging Qty (pcs)
SVPB	2.5	120	6.3	4.9	C5	1670	40	0.12	120	2R5SVPB120M	1300
	4.0	100	6.3	4.9		1670	40	0.12	160	4SVPB100M	1300
	6.3	82	6.3	4.9		1670	40	0.12	207	6SVPB82M	1300
	10	56	6.3	4.9		1670	40	0.12	224	10SVPB56M	1300
	16	33	6.3	4.9		1670	40	0.12	211	16SVPB33M	1300
	20	15	6.3	4.9		2000	45	0.12	120	20SVPB15M	1300
		22	6.3	5.4	C55	2000	35	0.12	88	20SVPB22M	1000

\*1 Ripple current (100 kHz/ +105 °C), \*2 ESR (100 kHz to 300 kHz/+20 °C) \*3 tan δ (120 Hz/+20 °C) \*4 After 2 minutes

◆ Please refer to each page in this catalog for "Reflow conditions" and "Taping specifications".

### Frequency correction factor for ripple current

Frequency	120 Hz ≤ f < 1 kHz	1 kHz ≤ f < 10 kHz	10 kHz ≤ f < 100 kHz	100 kHz ≤ f < 500 kHz
Coefficient	0.05	0.3	0.7	1

## Surface Mount Type



Series : **SVPC**



### Features

- Low ESR (9 mΩ to 30 mΩ)
- Large capacitance (2700 μF max.)
- RoHS compliance, Halogen free

### Specifications

Size code	B6	C6	E7	E12	F12
Category temperature range	-55 °C to +105 °C				
Rated voltage range	2.5 V.DC to 16 V.DC				2.5 V.DC
Rated capacitance range	39 μF to 180 μF	68 μF to 560 μF	120 μF to 680 μF	270 μF to 1500 μF	2700 μF
Capacitance tolerance	±20 % (120 Hz / + 20 °C)				
Leakage current	Please see the attached characteristics list				
Dissipation factor (tan δ)	Please see the attached characteristics list				
Endurance	+105 °C, 2000 h, rated voltage applied				
	Capacitance change	Within ±20 % of the initial value			
	tan δ	≤ 150 % of the initial limit			
	DC leakage current	Within the initial limit			
Damp heat (Steady State)	+60 °C, 90 % to 95 %, 1000 h, No-applied voltage				
	Capacitance change	Within ±20 % of the initial value			
	tan δ	≤ 150 % of the initial limit			
	DC leakage current	Within the initial limit (after voltage processing)			

### Marking

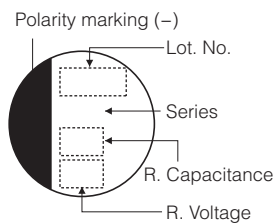

### Dimensions (not to scale)

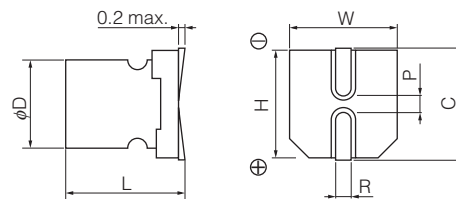

Unit : mm

Size code	φD±0.5	L <sup>+0.1</sup> <sub>-0.4</sub>	W±0.2	H±0.2	C±0.2	R	P±0.2
B6	5.0	5.9	5.3	5.3	6.0	0.6 to 0.8	1.4
C6	6.3	5.9	6.6	6.6	7.3	0.6 to 0.8	2.1
E7	8.0	6.9	8.3	8.3	9.0	0.6 to 0.8	3.2
E12	8.0	11.9	8.3	8.3	9.0	0.8 to 1.1	3.2
F12	10.0	12.6	10.3	10.3	11.0	0.8 to 1.1	4.6

\* Externals of figure are the reference.

## Characteristics list

Series	Rated voltage (V.DC)	Rated capacitance (μF)	Case size (mm)		Size code	Specifications					Standard (Reel size : φ380)	
			φD	L		Ripple* <sup>1</sup> current (mAr.m.s.)	ESR		tan δ* <sup>2</sup>	LC* <sup>3</sup> (μA)	Part number	Min. Packaging Qty (pcs)
							100 kHz/20 °C (mΩ max.)	300 kHz/20 °C (mΩ max.)				
SVPC	2.5	180	5.0	5.9	B6	1970	30	26	0.12	300	2R5SVPC180M	1500
			5.0	5.9		2200	24	20	0.12	300	2R5SVPC180MY	1500
			5.0	5.9		2800	19	16	0.12	300	2R5SVPC180MV	1500
		390	6.3	5.9	C6	2410	25	22	0.12	300	2R5SVPC390M	1000
			6.3	5.9		3160	15	13	0.12	300	2R5SVPC390MV	1000
			6.3	5.9		3500	16	14	0.12	300	2R5SVPC560M	1000
		680	8.0	6.9	E7	3370	20	17	0.12	500	2R5SVPC680M	1000
		820	8.0	11.9	E12	5380	9	8	0.15	500	2R5SVPC820M	400
		1500	8.0	11.9		5150	10	9	0.15	750	2R5SVPC1500M	400
	2700	10.0	12.6	F12	5070	12	10	0.15	1350	2R5SVPC2700M	400	
	4.0	150	5.0	5.9	B6	1970	30	26	0.12	300	4SVPC150M	1500
			5.0	5.9		2240	23	20	0.12	300	4SVPC150MY	1500
			5.0	5.9		2730	20	17	0.12	300	4SVPC150MV	1500
		330	6.3	5.9	C6	2320	27	23	0.12	300	4SVPC330M	1000
			6.3	5.9		2630	21	18	0.12	300	4SVPC330MY	1000
			6.3	5.9		3160	15	13	0.12	300	4SVPC330MV	1000
		560	8.0	6.9	E7	3220	22	19	0.12	500	4SVPC560M	1000
			8.0	11.9	E12	5380	9	8	0.15	500	4SVPC560MX	400
		1200	8.0	11.9		4700	12	10	0.15	960	4SVPC1200M	400
	1500	8.0	11.9	4700		12	10	0.15	1200	4SVPC1500M	400	
	6.3	100	5.0	5.9	B6	1970	30	26	0.12	300	6SVPC100M	1500
			5.0	5.9		2150	25	21	0.12	300	6SVPC100MY	1500
		120	5.0	5.9	C6	2660	21	18	0.12	300	6SVPC120MV	1500
		220	6.3	5.9		2320	27	23	0.12	300	6SVPC220M	1000
			6.3	5.9		3160	15	13	0.12	300	6SVPC220MV	1000
		330	6.3	5.9	E7	3390	17	15	0.12	415	6SVPC330M	1000
		390	8.0	6.9		3220	22	19	0.12	491	6SVPC390M	1000
	820	8.0	11.9	E12	4700	12	10	0.15	1033	6SVPC820M	400	
10	68	5.0	5.9	B6	1970	30	26	0.12	300	10SVPC68M	1500	
		5.0	5.9		2540	23	20	0.12	300	10SVPC68MV	1500	
	120	6.3	5.9	C6	2320	27	23	0.12	300	10SVPC120M	1000	
		6.3	5.9		2600	22	19	0.12	300	10SVPC120MV	1000	
	270	8.0	6.9	E7	3220	22	19	0.12	500	10SVPC270M	1000	
330	8.0	6.9	E7	3460	19	17	0.12	660	10SVPC330M	1000		
16	39	5.0		5.9	B6	1820	35	30	0.12	300	16SVPC39M	1500
		5.0	5.9	2350		27	23	0.12	300	16SVPC39MV	1500	
	68	6.3	5.9	C6	2200	30	26	0.12	300	16SVPC68M	1000	
		6.3	5.9		2440	25	22	0.12	300	16SVPC68MV	1000	
	100	6.3	5.9	E7	2490	24	23	0.12	300	16SVPC100M	1000	
	120	8.0	6.9		2900	27	23	0.12	500	16SVPC120M	1000	
	150	8.0	6.9		3220	22	21	0.12	500	16SVPC150M	1000	
270	8.0	11.9	E12	4070	16	14	0.15	864	16SVPC270M	400		

\*1 Ripple current (100 kHz/ +105 °C), \*2 tan δ (120 Hz/+20 °C) \*3 After 2 minutes

◆ Please refer to each page in this catalog for "Reflow conditions" and "Taping specifications".

## Frequency correction factor for ripple current

Frequency	120 Hz ≤ f < 1 kHz	1 kHz ≤ f < 10 kHz	10 kHz ≤ f < 100 kHz	100 kHz ≤ f < 500 kHz
Coefficient	0.05	0.3	0.7	1

## Surface Mount Type



## Series : SVPD

### Features

- 125 °C 2000 h
- Guaranteed at 85 °C 85 %
- RoHS compliance, Halogen free

### Specifications

Size code	C6	E7	F8	E12	F12
Category temperature range	-55 °C to +125 °C				
Rated voltage range	10 V.DC to 25 V.DC	16 V.DC to 35 V.DC	25 V.DC to 35 V.DC		
Rated capacitance range	10 μF to 56 μF	8.2 μF to 82 μF	18 μF to 39 μF	22 μF to 47 μF	47 μF to 82 μF
Capacitance tolerance	±20 % (120 Hz / + 20 °C)				
Leakage current	Please see the attached characteristics list				
Dissipation factor (tan δ)	Please see the attached characteristics list				
Endurance	+125 °C, 2000 h, rated voltage applied				
	Capacitance change	Within ±20 % of the initial value			
	tan δ	≤ 200 % of the initial limit			
	DC leakage current	Within the initial limit			
Damp heat (Steady State)	+85 °C, 85 % to 90 %, 1000 h, rated voltage applied				
	Capacitance change	Within ±20 % of the initial value			
	tan δ	≤ 200 % of the initial limit			
	DC leakage current	Within the initial limit (after voltage processing)			

### Marking

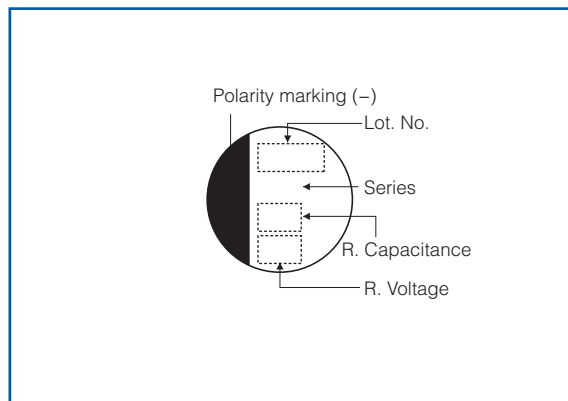

### Dimensions (not to scale)

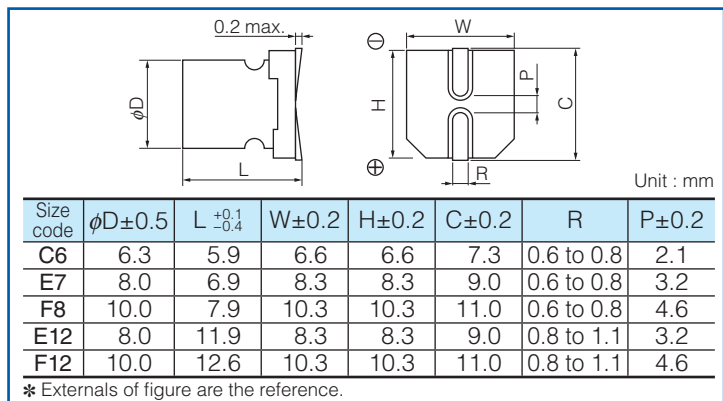

### Characteristics list

Series	Rated voltage (V.DC)	Rated capacitance (μF)	Case size (mm)		Size code	Specifications					Standard (Reel size : φ380)	
			φD	L		Ripple *1 (mAr.m.s.)	Allowable *1 ripple current (mAr.m.s.)	ESR *2 (mΩ max.)	tan δ *3	LC *4 (μA)	Part number	Min. Packaging Qty (pcs)
SVPD	10	56	6.3	5.9	C6	538	1700	45	0.12	112	10SVPD56M	1000
	16	82	8.0	6.9	E7	670	2120	40	0.12	262	16SVPD82M	1000
	25	10	6.3	5.9	C6	474	1500	65	0.10	50	25SVPD10M	1000
		22	8.0	6.9	E7	580	1835	48	0.10	110	25SVPD22M	1000
		39	10.0	7.9	F8	664	2100	45	0.10	195	25SVPD39M	500
		47	8.0	11.9	E12	943	2980	30	0.12	235	25SVPD47M	400
	35	82	10.0	12.6	F12	1202	3800	28	0.12	410	25SVPD82M	400
		8.2	8.0	6.9	E7	400	1300	70	0.10	57	35SVPD8R2M	1000
		18	10.0	7.9	F8	550	1800	60	0.10	126	35SVPD18M	500
		22	8.0	11.9	E12	700	2300	50	0.12	154	35SVPD22M	400
	47	10.0	12.6	F12	1150	3650	30	0.12	329	35SVPD47M	400	

\*1 Ripple current (100 kHz / +105 °C < Tx ≤ 125 °C), Allowable ripple current (100 kHz / Tx ≤ 105 °C)

\*2 ESR (100 kHz to 300 kHz/+20 °C) \*3 tan δ (120 Hz/+20 °C) \*4 After 2 minutes

◆ Please refer to each page in this catalog for "Reflow conditions" and "Taping specifications".

### Frequency correction factor for ripple current

Frequency	120 Hz ≤ f < 1 kHz	1 kHz ≤ f < 10 kHz	10 kHz ≤ f < 100 kHz	100 kHz ≤ f < 500 kHz
Coefficient	0.05	0.3	0.7	1

## Surface Mount Type



### Series : SVPE

#### Features

- Super low ESR (8 mΩ to 18 mΩ)
- Large capacitance (1200 μF max.)
- RoHS compliance, Halogen free

#### Specifications

Size code	B6	C6	C10	F12
Category temperature range	-55 °C to +105 °C			
Rated voltage range	2.5 V.DC to 6.3 V.DC	2.5 V.DC to 10 V.DC	2 V.DC to 16 V.DC	16 V.DC
Rated capacitance range	150 μF to 390 μF	220 μF to 390 μF	180 μF to 1200 μF	470 μF
Capacitance tolerance	±20 % (120 Hz / + 20 °C)			
Leakage current	Please see the attached characteristics list			
Dissipation factor (tan δ)	Please see the attached characteristics list			
Endurance	+105 °C, 2000 h, rated voltage applied			
	Capacitance change	Within ±20 % of the initial value		
	tan δ	≤ 150 % of the initial limit		
Damp heat (Steady State)	+60 °C, 90 % to 95 %, 1000 h, No-applied voltage			
	Capacitance change	Within ±20 % of the initial value		
	tan δ	≤ 150 % of the initial limit		
	DC leakage current	Within the initial limit (after voltage processing)		

#### Marking

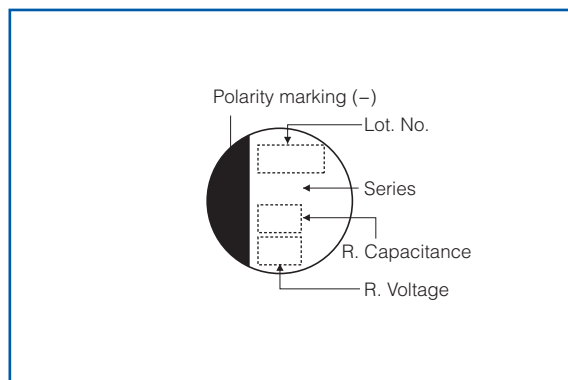

#### Dimensions (not to scale)

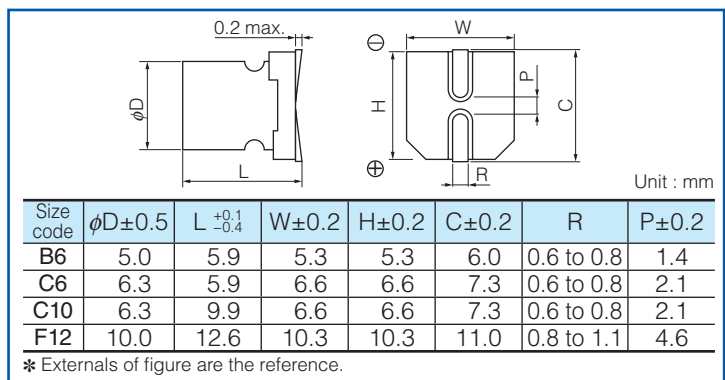

#### Characteristics list

Series	Rated voltage (V.DC)	Rated capacitance (μF)	Case size (mm)		Size code	Specifications					Standard (Reel size : φ380)	
			φD	L		Ripple *1 (mAr.m.s.)	ESR		tan δ *2	LC *3 (μA)	Part number	Min. Packaging Qty (pcs)
							100 kHz/20 °C (mΩ max.)	300 kHz/20 °C (mΩ max.)				
SVPE	2	1200	6.3	9.9	C10	5230	8	8	0.12	500	2SVPE1200M	500
						2.5	270	5.0	5.9	B6	3860	10
	3150	15	13	0.12	500						2R5SVPE330M	1500
	330	5.0	5.9	B6	3860		10	9	0.12	500	2R5SVPE330MY	1500
					3860		10	9	0.12	700	2R5SVPE390MX	1500
	390	6.3	5.0	5.9	C6	3900	10	9	0.12	500	2R5SVPE390M	1000
						6.3	150	5.0	5.9	B6	3520	12
	3150	15	13	0.12	500						6SVPE180M	1500
	220	5.0	5.9	B6	3150		15	13	0.12	500	6SVPE220MW	1500
					3900		10	9	0.12	500	6SVPE220M	1000
	10	6.3	5.0	5.9	C6	2700	20	18	0.12	500	10SVPE220M	1000
						16	180	6.3	9.9	C10	4460	11
	6100	10	9	0.12	1504						16SVPE470M	400

\*1 Ripple current (100 kHz/ +105 °C) \*2 tan δ (120 Hz/+20 °C) \*3 After 2 minutes  
 ♦ Please refer to each page in this catalog for "Reflow conditions" and "Taping specifications".

#### Frequency correction factor for ripple current

Frequency	120 Hz ≤ f < 1 kHz	1 kHz ≤ f < 10 kHz	10 kHz ≤ f < 100 kHz	100 kHz ≤ f < 500 kHz
Coefficient	0.05	0.3	0.7	1

## Surface Mount Type



Series : **SVPS**



### Features

- 105 °C 5000 h
- RoHS compliance, Halogen free

### Specifications

Size code	A5	B6	C6	E7	F8
Category temperature range	-55 °C to +105 °C				
Rated capacitance range	4 V.DC to 10 V.DC	4 V.DC to 16 V.DC	4 V.DC to 20 V.DC	4 V.DC to 25 V.DC	4 V.DC to 16 V.DC
Rated capacitance range	10 μF to 33 μF	22 μF to 68 μF	22 μF to 150 μF	10 μF to 270 μF	100 μF to 680 μF
Capacitance tolerance	±20 % (120 Hz / + 20 °C)				
Leakage current	Please see the attached characteristics list				
Dissipation factor (tan δ)	Please see the attached characteristics list				
Endurance	+105 °C, 5000 h, rated voltage applied (25 V.DC → 20 V.DC applied)				
	Capacitance change	Within ±20 % of the initial value			
	tan δ	≤ 150 % of the initial limit			
	DC leakage current	Within the initial limit			
Damp heat (Steady State)	+60 °C, 90 % to 95 %, 1000 h, No-applied voltage				
	Capacitance change	Within ±20 % of the initial value			
	tan δ	≤ 150 % of the initial limit			
	DC leakage current	Within the initial limit (after voltage processing)			

### Marking

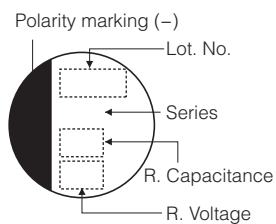

### Dimensions (not to scale)

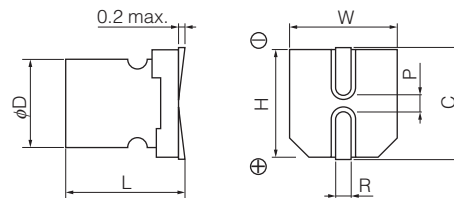

Unit : mm

Size code	φD±0.5	L <sup>+0.1</sup> <sub>-0.4</sub>	W±0.2	H±0.2	C±0.2	R	P±0.2
A5	4.0	5.4	4.3	4.3	5.0	0.6 to 0.8	1.0
B6	5.0	5.9	5.3	5.3	6.0	0.6 to 0.8	1.4
C6	6.3	5.9	6.6	6.6	7.3	0.6 to 0.8	2.1
E7	8.0	6.9	8.3	8.3	9.0	0.6 to 0.8	3.2
F8	10.0	7.9	10.3	10.3	11.0	0.6 to 0.8	4.6

\* Externals of figure are the reference.



## Characteristics list

Series	Rated voltage (V.DC)	Rated capacitance (μF)	Case size (mm)		Size code	Specifications				Standard (Reel size : φ380)	
			φD	L		Ripple current* <sup>1</sup> (mA r.m.s.)	ESR* <sup>2</sup> (mΩ max.)	tan δ* <sup>3</sup>	LC* <sup>4</sup> (μA)	Part number	Min. Packaging Qty (pcs)
SVPS	4.0	33	4.0	5.4	A5	740	200	0.15	66	4SVPS33M	2000
		68	5.0	5.9	B6	1970	30	0.12	300	4SVPS68M	1500
		150	6.3	5.9	C6	2570	22	0.12	300	4SVPS150M	1000
		270	8.0	6.9	E7	3220	22	0.12	500	4SVPS270M	1000
		680	10.0	7.9	F8	4130	20	0.12	544	4SVPS680M	500
	6.3	22	4.0	5.4	A5	740	200	0.12	69.3	6SVPS22M	2000
		47	5.0	5.9	B6	1970	30	0.12	300	6SVPS47M	1500
		120	6.3	5.9	C6	2570	22	0.12	300	6SVPS120M	1000
		220	8.0	6.9	E7	3220	22	0.12	500	6SVPS220M	1000
		470	10.0	7.9	F8	4130	20	0.12	592	6SVPS470M	500
	10	10	4.0	5.4	A5	700	220	0.10	50	10SVPS10M	2000
			4.0	5.4		740	200	0.10	75	10SVPS15M	2000
		150	5.0	5.9	B6	1100	70	0.12	165	10SVPS33M	1500
			6.3	5.9	C6	2200	30	0.12	300	10SVPS68M	1000
			8.0	6.9	E7	2760	30	0.12	500	10SVPS150MX	1000
				7.9	F8	3020	30	0.12	300	10SVPS150M	500
			10.0	7.9		3770	24	0.12	660	10SVPS330M	500
	16	22	5.0	5.9	B6	1060	90	0.10	176	16SVPS22M	1500
		39	6.3	5.9	C6	2460	24	0.12	300	16SVPS39M	1000
		82	8.0	6.9	E7	2760	30	0.12	262	16SVPS82M	1000
		100	10.0	7.9	F8	2670	35	0.12	320	16SVPS100M	500
			180	7.9		3430	29	0.12	576	16SVPS180M	500
	20	22	6.3	5.9	C6	1450	60	0.10	88	20SVPS22M	1000
		47	8.0	6.9	E7	1890	45	0.12	188	20SVPS47M	1000
			10	8.0		6.9	1500	60	0.10	125	25SVPS10M

\*1 Ripple current (100 kHz/ +105 °C),

: The surface temperature of aluminum case top must not exceed 105 °C. A rise in temperature due to self-heating by ripple current should be factored in.

\*2 ESR (100 kHz to 300 kHz/+20 °C) \*3 tan δ (120 Hz/+20 °C) \*4 After 2 minutes

◆ Please refer to each page in this catalog for "Reflow conditions" and "Taping specifications".

## Frequency correction factor for ripple current

Frequency	120 Hz ≤ f < 1 kHz	1 kHz ≤ f < 10 kHz	10 kHz ≤ f < 100 kHz	100 kHz ≤ f < 500 kHz
Coefficient	0.05	0.3	0.7	1

## Surface Mount Type



### Series : SVQP

#### Features

- 125 °C 1000 h
- RoHS compliance, Halogen free

#### Specifications

Size code	C6	E7
Category temperature range	-55 °C to +125 °C	
Rated voltage range	4 V.DC to 20 V.DC	6.3 V.DC to 20 V.DC
Rated capacitance range	22 μF to 150 μF	47 μF to 220 μF
Capacitance tolerance	±20 % (120 Hz / + 20 °C)	
Leakage current	Please see the attached characteristics list	
Dissipation factor (tan δ)	Please see the attached characteristics list	
Endurance	+125 °C, 1000 h, rated voltage applied	
	Capacitance change	Within ±20 % of the initial value
	tan δ	≤ 200 % of the initial limit
Damp heat (Steady State)	+60 °C, 90 % to 95 %, 1000 h, No-applied voltage	
	Capacitance change	Within ±20 % of the initial value
	tan δ	≤ 150 % of the initial limit
	DC leakage current	Within the initial limit (after voltage processing)

#### Marking

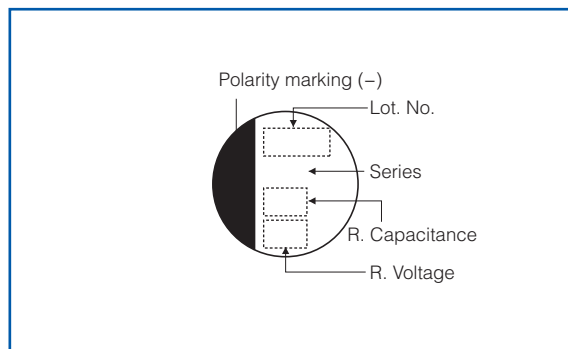

#### Dimensions (not to scale)

Size code	φD±0.5	L <sup>+0.1</sup> <sub>-0.4</sub>	W±0.2	H±0.2	C±0.2	R	P±0.2
C6	6.3	5.9	6.6	6.6	7.3	0.6 to 0.8	2.1
E7	8.0	6.9	8.3	8.3	9.0	0.6 to 0.8	3.2

\* Externals of figure are the reference.

#### Characteristics list

Series	Rated voltage (V.DC)	Rated capacitance (μF)	Case size (mm)		Size code	Specifications					Standard (Reel size : φ380)		
			φD	L		Ripple current* <sup>1</sup> (mAr.m.s.)	Allowable* <sup>1</sup> ripple current (mAr.m.s.)	ESR* <sup>2</sup> (mΩ max.)	tan δ* <sup>3</sup>	LC* <sup>4</sup> (μA)	Part number	Min. Packaging Q'ty (pcs)	
SVQP	4.0	150	6.3	5.9	C6	572	1810	40	0.12	300	4SVQP150M	1000	
		82	6.3	5.9		538	1700	45	0.12	258	6SVQP82M	1000	
	100	6.3	5.9	572		1810	40	0.12	315	6SVQP100M	1000		
	6.3	220	8.0	6.9	E7	810	2560	35	0.12	693	6SVQP220M	1000	
		56	6.3	5.9	C6	538	1700	45	0.12	280	10SVQP56M	1000	
	10	120	8.0	6.9		E7	810	2560	35	0.12	600	10SVQP120M	1000
	150	8.0	6.9	810			2560	35	0.12	750	10SVQP150M	1000	
	16	39	6.3	5.9	C6	512	1620	50	0.10	312	16SVQP39M	1000	
		82	8.0	6.9	E7	670	2120	40	0.12	656	16SVQP82M	1000	
	20	22	6.3	5.9	C6	459	1450	60	0.10	220	20SVQP22M	1000	
		47	8.3	6.9	E7	598	1890	45	0.12	470	20SVQP47M	1000	

\*<sup>1</sup> Ripple current (100 kHz / +105 °C < Tx ≤ 125 °C), Allowable ripple current (100 kHz / Tx ≤ 105 °C)

\*<sup>2</sup> ESR (100 kHz to 300 kHz / +20 °C) \*<sup>3</sup> tan δ (120 Hz / +20 °C) \*<sup>4</sup> After 2 minutes

◆ Please refer to each page in this catalog for "Reflow conditions" and "Taping specifications".

#### Frequency correction factor for ripple current

Frequency	120 Hz ≤ f < 1 kHz	1 kHz ≤ f < 10 kHz	10 kHz ≤ f < 100 kHz	100 kHz ≤ f < 500 kHz
Coefficient	0.05	0.3	0.7	1

Design and specifications are each subject to change without notice. Ask factory for the current technical specifications before purchase and/or use.

Should a safety concern arise regarding this product, please be sure to contact us immediately.

## Surface Mount Type



Series : **SVP**



### Features

- Standard
- Wealth models
- RoHS compliance, Halogen free

### Specifications

Size code	A5	B6	C6	E7	F8	E12	F12
Category temperature range	-55 °C to +105 °C						
Rated voltage range	4 V.DC to 16 V.DC	4 V.DC to 20 V.DC	2.5 V.DC to 20 V.DC	4 V.DC to 20 V.DC		2.5 V.DC to 20 V.DC	
Rated capacitance range	3.3 μF to 33 μF	10 μF to 68 μF	22 μF to 220 μF	33 μF to 330 μF	56 μF to 680 μF	100 μF to 680 μF	150 μF to 1500 μF
Capacitance tolerance	±20 % (120 Hz / + 20 °C)						
Leakage current	Please see the attached characteristics list						
Dissipation factor (tan δ)	Please see the attached characteristics list						
Endurance	+105 °C, 2000 h, rated voltage applied						
	Capacitance change	Within ±20 % of the initial value					
	tan δ	≤ 150 % of the initial limit					
	DC leakage current	Within the initial limit					
Damp heat (Steady State)	+60 °C, 90 % to 95 %, 1000 h, No-applied voltage						
	Capacitance change	Within ±20 % of the initial value					
	tan δ	≤ 150 % of the initial limit					
	DC leakage current	Within the initial limit (after voltage processing)					

### Marking

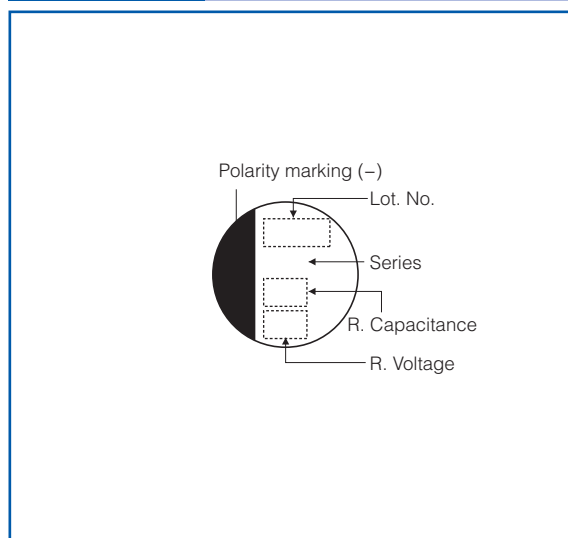

### Dimensions (not to scale)

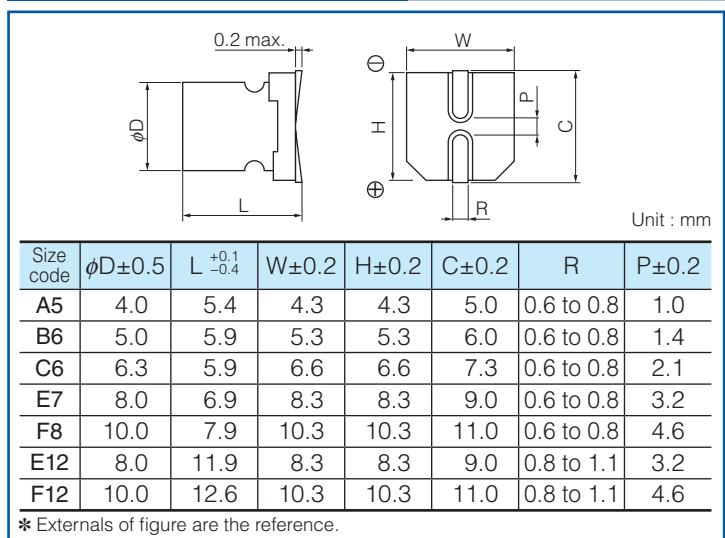

## Characteristics list

Series	Rated voltage (V.DC)	Rated capacitance (μF)	Case size (mm)		Size code	Specifications				Standard (Reel size : φ380)	
			φD	L		Ripple current* <sup>1</sup> (mAr.m.s.)	ESR* <sup>2</sup> (mΩ max.)	tan δ* <sup>3</sup>	LC* <sup>4</sup> (μA)	Part number	Min. Packaging Qty (pcs)
SVP	2.5	220	6.3	5.9	C6	2390	23	0.12	110	2R5SVP220M	1000
		680	8.0	11.9	E12	4520	13	0.15	340	2R5SVP680M	400
		1500	10.0	12.6	F12	5440	12	0.18	750	2R5SVP1500M	400
	4.0	33	4.0	5.4	A5	740	200	0.15	66	4SVP33M	2000
		39	5.0	5.9	B6	1100	70	0.12	78	4SVP39M	1500
		68	5.0	5.9		1400	60	0.12	136	4SVP68M	1500
		150	6.3	5.9	C6	1810	40	0.12	120	4SVP150MX	1000
		330	8.0	6.9	E7	2560	35	0.12	264	4SVP330M	1000
		560	8.0	11.9	E12	4520	13	0.15	448	4SVP560M	400
		680	10.0	7.9	F8	3700	25	0.12	544	4SVP680M	500
1200		10.0	12.6	F12	5440	12	0.18	960	4SVP1200M	400	
6.3	22	4.0	5.4	A5	740	200	0.12	69.3	6SVP22M	2000	
	47	5.0	5.9	B6	1100	70	0.12	148	6SVP47M	1500	
	82	6.3	5.9	C6	1700	45	0.12	103	6SVP82M	1000	
	100	6.3	5.9		1810	40	0.12	126	6SVP100M	1000	
	120	6.3	5.9		2780	17	0.12	151	6SVP120MV	1000	
	220	8.0	6.9	E7	2560	35	0.12	277	6SVP220MX	1000	
	330	10.0	7.9	F8	3700	25	0.12	277	6SVP220M	500	
		3700	25		0.12	416	6SVP330M	500			
	470	10.0	7.9	E12	3700	25	0.12	592	6SVP470MX	500	
		8.0	11.9		4210	15	0.15	592	6SVP470M	400	
	820	10.0	12.6	F12	5440	12	0.15	775	6SVP820M	400	
	10	4.7	4.0	5.4	A5	670	240	0.08	23.5	10SVP4R7M	2000
6.8		4.0	5.4	670		240	0.09	34	10SVP6R8M	2000	
10		4.0	5.4	700		220	0.10	50	10SVP10M	2000	
15		4.0	5.4	740		200	0.10	75	10SVP15M	2000	
33		5.0	5.9	B6	1100	70	0.12	165	10SVP33M	1500	
47		6.3	5.9	C6	1620	50	0.12	94	10SVP47M	1000	
56		6.3	5.9		1700	45	0.12	112	10SVP56M	1000	
120		8.0	6.9	E7	2560	35	0.12	240	10SVP120M	1000	
150		8.0	6.9	F8	2560	35	0.12	300	10SVP150MX	1000	
		10.0	7.9		3020	30	0.12	300	10SVP150M	500	
270		10.0	7.9	E12	3700	25	0.12	540	10SVP270M	500	
		10.0	7.9		3700	25	0.12	660	10SVP330MX	500	
330		8.0	11.9	F12	3950	17	0.15	660	10SVP330M	400	
		10.0	12.6		5230	13	0.15	840	10SVP560M	400	
16	3.3	4.0	5.4	A5	660	260	0.07	26.4	16SVP3R3M	2000	
	15	5.0	5.9	B6	1020	120	0.10	120	16SVP15M	1500	
	22	5.0	5.9		1060	90	0.10	176	16SVP22M	1500	
	39	6.3	5.9	C6	1620	50	0.10	125	16SVP39M	1000	
	56	8.0	6.9	E7	1890	45	0.12	179	16SVP56M	1000	
	82	8.0	6.9		2120	40	0.12	262	16SVP82M	1000	
	100	10.0	7.9	F8	2670	35	0.12	320	16SVP100M	500	
	150	10.0	7.9		3020	30	0.12	480	16SVP150M	500	
	180	10.0	7.9	E12	3020	30	0.12	576	16SVP180MX	500	
		8.0	11.9		3640	20	0.15	576	16SVP180M	400	
	330	10.0	12.6	F12	4720	16	0.15	792	16SVP330M	400	
	20	10	5.0	5.9	B6	1020	120	0.10	100	20SVP10M	1500
22		6.3	5.9	C6	1450	60	0.10	88	20SVP22M	1000	
27		6.3	5.9		1450	60	0.10	108	20SVP27M	1000	
33		8.0	6.9	E7	1890	45	0.12	132	20SVP33M	1000	
47		8.0	6.9		1890	45	0.12	188	20SVP47M	1000	
56		10.0	7.9	F8	2400	40	0.12	224	20SVP56M	500	
68		10.0	7.9		2400	40	0.12	272	20SVP68M	500	
100		8.0	11.9	E12	3320	24	0.15	400	20SVP100M	400	
150	10.0	12.6	F12	4320	20	0.15	600	20SVP150M	400		

\*1 Ripple current (100 kHz/ +105 °C) \*2 ESR (100 kHz to 300 kHz/+20 °C) \*3 tan δ (120 Hz/+20 °C) \*4 After 2 minutes  
 ◆ Please refer to each page in this catalog for "Reflow conditions" and "Taping specifications".

## Frequency correction factor for ripple current

Frequency	120 Hz ≤ f < 1 kHz	1 kHz ≤ f < 10 kHz	10 kHz ≤ f < 100 kHz	100 kHz ≤ f < 500 kHz
Coefficient	0.05	0.3	0.7	1

Design and specifications are each subject to change without notice. Ask factory for the current technical specifications before purchase and/or use.  
 Should a safety concern arise regarding this product, please be sure to contact us immediately.

## Radial Lead Type



Series : **SEF**

### Features

- High voltage (35 V.DC max.)
- Large capacitance (1000  $\mu$ F max.)
- RoHS compliance, Halogen free

### Specifications

Size code	C6	E7	E12	F13
Category temperature range	-55 °C to +125 °C			
Rated voltage range	16 V.DC to 35 V.DC			
Rated capacitance range	22 $\mu$ F to 180 $\mu$ F	39 $\mu$ F to 270 $\mu$ F	82 $\mu$ F to 560 $\mu$ F	120 $\mu$ F to 1000 $\mu$ F
Capacitance tolerance	$\pm$ 20 % (120 Hz / + 20 °C)			
Leakage current	Please see the attached characteristics list			
Dissipation factor (tan $\delta$ )	Please see the attached characteristics list			
Endurance	+125 °C, 1000 h, rated voltage applied			
	Capacitance change	Within $\pm$ 20 % of the initial value		
	tan $\delta$	$\leq$ 200 % of the initial limit		
	DC leakage current	Within the initial limit		
Damp heat (Steady State)	+60 °C, 90 % to 95 %, 1000 h, No-applied voltage			
	Capacitance change	Within $\pm$ 20 % of the initial value		
	tan $\delta$	$\leq$ 150 % of the initial limit		
	DC leakage current	Within the initial limit (after voltage processing)		

### Marking

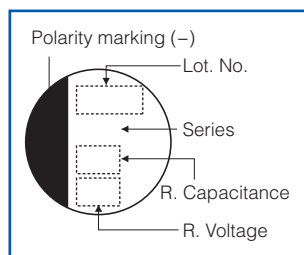

### Dimensions (not to scale)

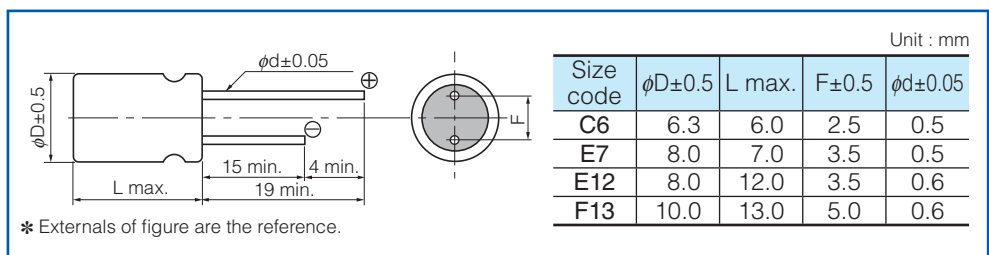

### Characteristics list

Series	Rated voltage (V.DC)	Rated capacitance ( $\mu$ F)	Case size (mm)			Specifications					Part number
			$\phi$ D	L	Size code	Ripple current* <sup>1</sup> (mAr.m.s.)	Allowable* <sup>1</sup> ripple current (mAr.m.s.)	ESR* <sup>2</sup> (m $\Omega$ max.)	tan $\delta$ * <sup>3</sup>	LC* <sup>4</sup> ( $\mu$ A)	
SEF	16	180	6.3	6.0	C6	1040	3300	22	0.12	576	16SEF180M
		270	8.0	7.0	E7	1040	3300	22	0.12	864	16SEF270M
		560	8.0	12.0	E12	1560	4950	14	0.12	1792	16SEF560M
		1000	10.0	13.0	F13	1700	5400	12	0.12	3200	16SEF1000M
	20	120	6.3	6.0	C6	1010	3200	25	0.12	480	20SEF120M
		180	8.0	7.0	E7	1010	3200	25	0.12	720	20SEF180M
		390	8.0	12.0	E12	1560	4950	14	0.12	1560	20SEF390M
		560	10.0	13.0	F13	1700	5400	12	0.12	2240	20SEF560M
	25	56	6.3	6.0	C6	880	2800	30	0.12	280	25SEF56M
		82	8.0	7.0	E7	940	3000	28	0.12	410	25SEF82M
		180	8.0	12.0	E12	1470	4650	16	0.12	900	25SEF180M
		330	10.0	13.0	F13	1580	5000	14	0.12	1650	25SEF330M
35	22	6.3	6.0	C6	820	2600	35	0.12	154	35SEF22M	
	39	8.0	7.0	E7	880	2800	30	0.12	273	35SEF39M	
	82	8.0	12.0	E12	1260	4000	20	0.12	574	35SEF82M	
	120	10.0	13.0	F13	1390	4400	18	0.12	840	35SEF120M	

\*<sup>1</sup> Ripple current (100 kHz/ +105 °C < Tx  $\leq$  +125 °C) / Allowable ripple current (100 kHz/ Tx  $\leq$  +105 °C), \*<sup>2</sup> ESR (100 kHz to 300 kHz/+20 °C)

\*<sup>3</sup> tan  $\delta$  (120 Hz/+20 °C) \*<sup>4</sup> After 2 minutes

◆ Please refer to each page in this catalog for "Flow conditions" and "Taping specifications".

### Frequency correction factor for ripple current

Frequency	120 Hz $\leq$ f < 1 kHz	1 kHz $\leq$ f < 10 kHz	10 kHz $\leq$ f < 100 kHz	100 kHz $\leq$ f < 500 kHz
Coefficient	0.05	0.3	0.7	1

Design and specifications are each subject to change without notice. Ask factory for the current technical specifications before purchase and/or use.

Should a safety concern arise regarding this product, please be sure to contact us immediately.

## Radial Lead Type

Series : **SEK**



# OS-CON



### Features

- High voltage (50 V.DC max.)
- RoHS compliance, Halogen free
- 125 °C 1000 h

### Specifications

Size code	C6	E7	E12	F13
Category temperature range	-55 °C to +125 °C			
Rated voltage range	25 V.DC to 50 V.DC			
Rated capacitance range	22 μF to 82 μF	33 μF to 120 μF	68 μF to 270 μF	120 μF to 470 μF
Capacitance tolerance	±20 % (120 Hz / + 20 °C)			
Leakage current	Please see the attached characteristics list			
Dissipation factor (tan δ)	Please see the attached characteristics list			
Endurance	+125 °C, 1000 h, rated voltage applied			
	Capacitance change	Within ±20 % of the initial value		
	tan δ	≤ 200 % of the initial limit		
	DC leakage current	Within the initial limit		
Damp heat (Steady State)	+60 °C, 90 % to 95 %, 1000 h, No-applied voltage			
	Capacitance change	Within ±20 % of the initial value		
	tan δ	≤ 150 % of the initial limit		
	DC leakage current	Within the initial limit (after voltage processing)		

### Marking

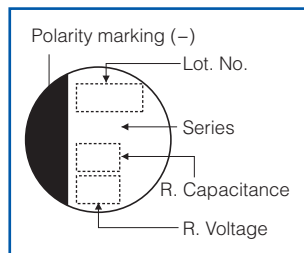

### Dimensions (not to scale)

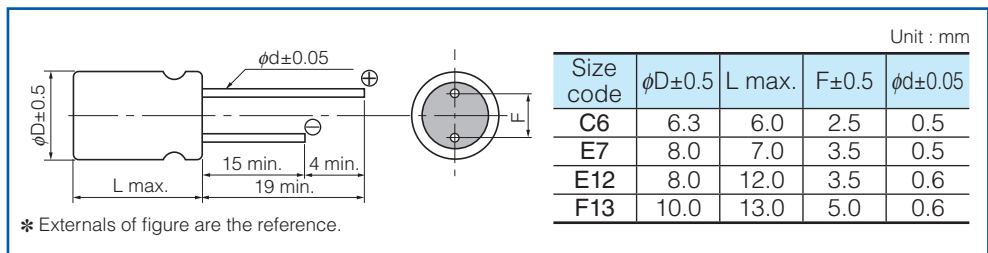

### Characteristics list

Series	Rated voltage (V.DC)	Rated capacitance (μF)	Case size (mm)		Size code	Specifications					Part number
			φD	L		Ripple current* <sup>1</sup> (mAr.m.s.)	Allowable* <sup>1</sup> ripple current (mAr.m.s.)	ESR* <sup>2</sup> (mΩ max.)	tan δ* <sup>3</sup>	LC* <sup>4</sup> (μA)	
SEK	25	82	6.3	6.0	C6	960	3060	25	0.12	410	25SEK82M
		120	8.0	7.0	E7	1010	3200	24	0.12	600	25SEK120M
		270	8.0	12.0	E12	1470	4650	16	0.12	1350	25SEK270M
		470	10.0	13.0	F13	1590	5000	14	0.12	2350	25SEK470M
	35	47	6.3	6.0	C6	930	2950	27	0.12	329	35SEK47M
		82	8.0	7.0	E7	960	3060	25	0.12	574	35SEK82M
		180	8.0	12.0	E12	1260	4000	20	0.12	1260	35SEK180M
		330	10.0	13.0	F13	1390	4400	18	0.12	2310	35SEK330M
	50	22	6.3	6.0	C6	820	2600	35	0.12	220	50SEK22M
		33	8.0	7.0	E7	850	2700	35	0.12	330	50SEK33M
		68	8.0	12.0	E12	1200	3800	25	0.12	680	50SEK68M
		120	10.0	13.0	F13	1350	4300	20	0.12	1200	50SEK120M

\*<sup>1</sup> Ripple current (100 kHz/ +105 °C < Tx ≤ +125 °C) / Allowable ripple current (100 kHz/ Tx ≤ +105 °C), \*<sup>2</sup> ESR (100 kHz to 300 kHz/+20 °C)

\*<sup>3</sup> tan δ (120 Hz/+20 °C) \*<sup>4</sup> After 2 minutes

◆ Please refer to each page in this catalog for "Flow conditions" and "Taping specifications".

### Frequency correction factor for ripple current

Frequency	120 Hz ≤ f < 1 kHz	1 kHz ≤ f < 10 kHz	10 kHz ≤ f < 100 kHz	100 kHz ≤ f < 500 kHz
Coefficient	0.05	0.3	0.7	1

## Radial Lead Type

Series: **SEPG**



**OS-CON**

**UPGRADE**

### Features

- High ripple current (6100 mA r.m.s. max.)
- RoHS compliance, Halogen free

### Specifications

Size code	C9	C10	E9	E13
Category temp. range	-55 °C to +105 °C			
Rated voltage range	16 V.DC			
Rated cap. range	270 μF		470 μF	560 μF
Capacitance tolerance	±20 % (120 Hz / +20 °C)			
Leakage current	Please see the attached characteristics list			
Dissipation factor (tan δ)	Please see the attached characteristics list			
Endurance	+105 °C, 5000 h, rated voltage applied			
	Capacitance change	Within ±20 % of the initial value		
	Dissipation factor (tan δ)	≤ 200 % of the initial limit		
	DC leakage current	Within the initial limit		
Damp heat (Steady State)	+60 °C, 90 % to 95 %, 1000 h, No-applied voltage			
	Capacitance change	Within ±20 % of the initial value		
	Dissipation factor (tan δ)	≤ 150 % of the initial limit		
	DC leakage current	Within the initial limit (after voltage processing)		

### Marking

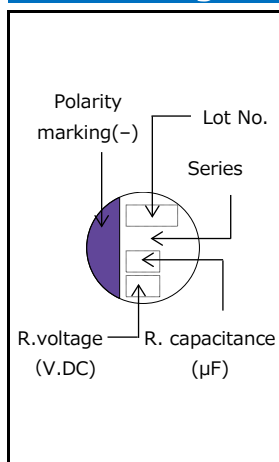

### Dimensions (not to scale)

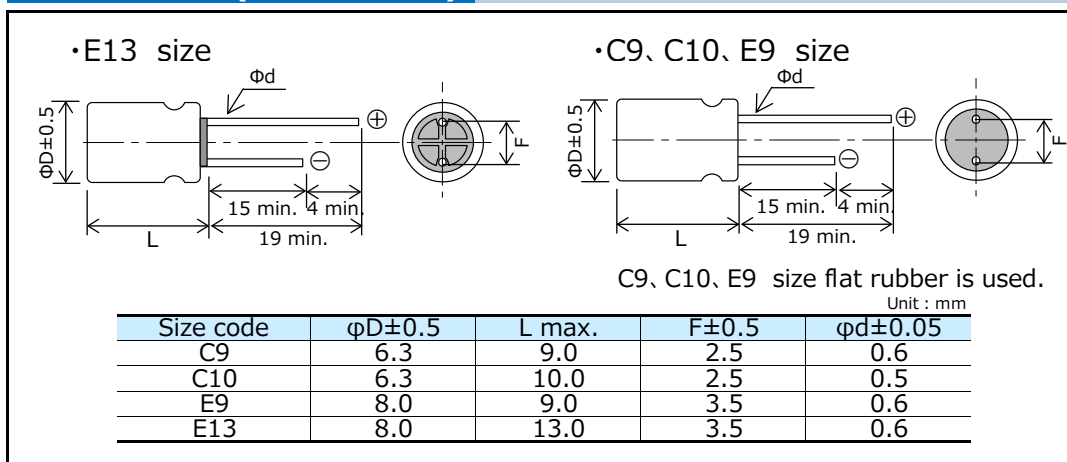

### Characteristics list

Rated volt. (V.DC)	Rated cap. (±20 %) (μF)	Case size (mm)		Size code	Specifications				Part number
		φD	L		Ripple current *1 (mA r.m.s.)	ESR *2 (mΩ)	tan δ *3	LC *4 (μA)	
16	270	6.3	8.9	C9	5040	10	0.12	864	16SEPG270W
		6.3	9.9	C10	5800	8	0.12	864	16SEPG270M
	470	8.0	8.9	E9	5400	8	0.12	1504	16SEPG470M
		<b>NEW</b> 8.0	<b>12.9</b>	<b>E13</b>	<b>6100</b>	<b>8</b>	<b>0.12</b>	<b>1792</b>	<b>16SEPG560M</b>

\*1: Ripple current (100 kHz / +105 °C) \*2: ESR (100 kHz / +20 °C) \*3: tan δ (120 Hz / +20 °C) \*4: After 2 minutes  
 \*Please refer to each page in this catalog for "Flow conditions" and "Taping specifications".

### Frequency correction factor for ripple current

Frequency(f)	120 Hz ≤ f < 1 kHz	1 kHz ≤ f < 10 kHz	10 kHz ≤ f < 100 kHz	100 kHz ≤ f < 500 kHz
Coefficient	0.05	0.3	0.7	1

## Radial Lead Type

Series: **SXE**



**OS-CON**

**UPGRADE**

### Features

- Super high voltage (100 V.DC max.)
- RoHS compliance, Halogen free

### Specifications

Size code	E7	F8	E12	F13
Category temp. range	-55 °C to +125 °C			
Rated voltage range	63 V.DC to 100 V.DC			
Nominal cap.range	6.8 μF to 18 μF	15 μF to 39 μF	15 μF to 56 μF	18 μF to 100 μF
Capacitance tolerance	±20 % (120 Hz / +20 °C)			
DC leakage current	Please see the attached characteristics list			
Dissipation factor (tan δ)	Please see the attached characteristics list			
Endurance	+125 °C, 1000 h, rated voltage applied			
	Capacitance change	Within ±20 % of the initial value		
	Dissipation factor (tanδ)	≤ 200 % of the initial limit		
	DC leakage current	Within the initial limit		
	+60 °C, 90 % to 95 %, 1000 h, No-applied voltage			
	Capacitance change	Within ±20 % of the initial value		
	Dissipation factor (tanδ)	≤ 150 % of the initial limit		
	DC leakage current	Within the initial limit (after voltage processing)		

### Marking

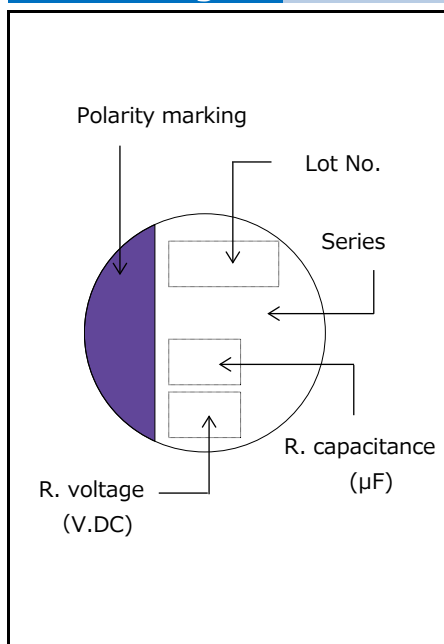

### Dimensions (not to scale)

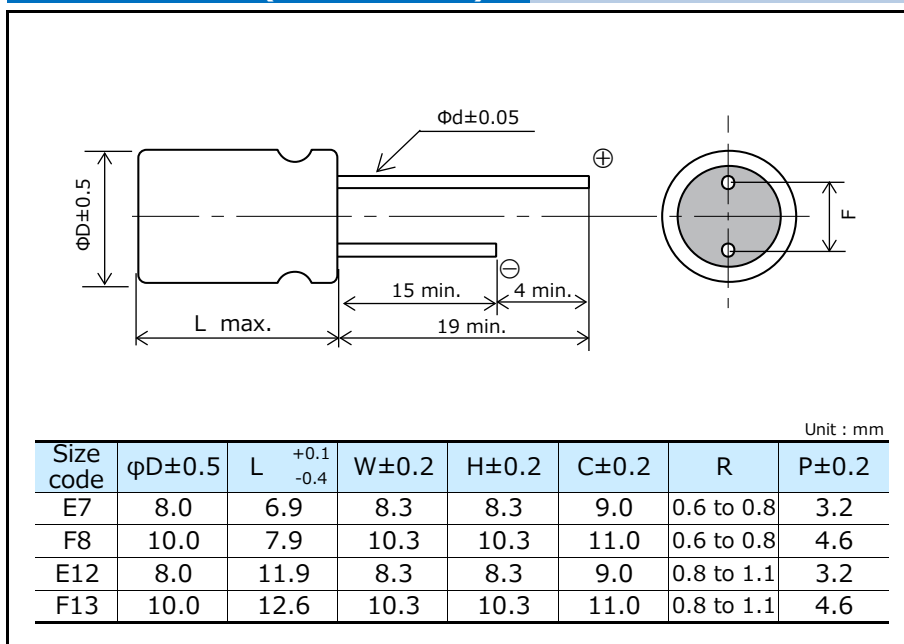



# Panasonic Conductive Polymer Aluminum Solid Capacitors

## Characteristics list

Rated volt. (V.DC)	Rated cap. ( $\pm 20\%$ ) ( $\mu\text{F}$ )	Case size (mm)		Size code	Specifications					Part number
		$\phi\text{D}$	L		Ripple current* <sup>1</sup> (mA r.m.s.)	Allowable ripple current* <sup>1</sup> (mA r.m.s.)	ESR* <sup>2</sup> (m $\Omega$ )	$\tan \delta$ * <sup>3</sup>	LC* <sup>4</sup> ( $\mu\text{A}$ )	
63	18	8.0	7.0	E7	340	1100	60	0.12	56	63SXE18M
	33	8.0	12.0	E12	930	2950	25	0.12	104	63SXE33M
	39	8.0	12.0	E12	930	2950	25	0.12	122	63SXE39M
		10.0	8.0	F8	690	2190	50	0.12	122	63SXE39MX
	<b>NEW</b> 56	8.0	12.0	E12	930	2950	25	0.12	176	63SXE56M
	68	10.0	13.0	F13	1030	3280	25	0.12	214	63SXE68M
<b>NEW</b> 100	10.0	13.0	F13	1030	3280	25	0.12	315	63SXE100M	
80	12	8.0	7.0	E7	340	1100	60	0.12	48	80SXE12M
	27	8.0	12.0	E12	780	2490	35	0.12	108	80SXE27M
		10.0	8.0	F8	660	2080	55	0.12	108	80SXE27MX
	<b>NEW</b> 33	8.0	12.0	E12	780	2490	35	0.12	132	80SXE33M
	47	10.0	13.0	F13	980	3100	28	0.12	980	80SXE47M
<b>NEW</b> 56	10.0	13.0	F13	980	3100	28	0.12	224	80SXE56M	
100	6.8	8.0	7.0	E7	340	1100	60	0.12	34	100SXE6R8M
	15	10.0	8.0	F8	630	2000	60	0.12	75	100SXE15MX
		8.0	12.0	E12	730	2350	40	0.12	75	100SXE15M
	18	10.0	13.0	F13	940	3000	30	0.12	90	100SXE18M
		<b>NEW</b> 18	8.0	12.0	E12	730	2350	40	0.12	90
	22	10.0	13.0	F13	940	3000	30	0.12	110	100SXE22M
<b>NEW</b> 27	10.0	13.0	F13	940	3000	30	0.12	135	100SXE27M	

\*1: Ripple current (100 kHz /  $+105\text{ }^\circ\text{C} < T_x \leq +125\text{ }^\circ\text{C}$ ) / Allowable ripple current (100 kHz /  $T_x \leq +105\text{ }^\circ\text{C}$ )

\*2: ESR (100 kHz to 300 kHz /  $+20\text{ }^\circ\text{C}$ )

\*3:  $\tan \delta$  (120 Hz /  $+20\text{ }^\circ\text{C}$ )

\*4: After 2 minutes

• Please refer to each page in this catalog for "Reflow conditions" and "Taping specifications".

## Frequency correction factor for ripple current

Frequency(f)	$120\text{ Hz} \leq f < 1\text{ kHz}$	$1\text{ kHz} \leq f < 10\text{ kHz}$	$10\text{ kHz} \leq f < 100\text{ kHz}$	$100\text{ kHz} \leq f < 500\text{ kHz}$
Coefficient	0.05	0.3	0.7	1

## Radial Lead Type

# OS-CON



Series : **SEPF**

### Features

- High voltage (35 V.DC max.)
- Large capacitance (1000  $\mu$ F max.)
- RoHS compliance, Halogen free

### Specifications

Size code	C55	C6	E7	E12	F13
Category temperature range	-55 °C to +105 °C				
Rated voltage range	16 V.DC to 32 V.DC		16 V.DC to 35 V.DC		
Rated capacitance range	22 $\mu$ F to 150 $\mu$ F	22 $\mu$ F to 180 $\mu$ F	39 $\mu$ F to 270 $\mu$ F	82 $\mu$ F to 560 $\mu$ F	120 $\mu$ F to 1000 $\mu$ F
Capacitance tolerance	$\pm$ 20 % (120 Hz / + 20 °C)				
Leakage current	Please see the attached characteristics list				
Dissipation factor (tan $\delta$ )	Please see the attached characteristics list				
Endurance	+105 °C, 5000 h, rated voltage applied				
	Capacitance change	Within $\pm$ 20 % of the initial value			
	tan $\delta$	$\leq$ 150 % of the initial limit			
	DC leakage current	Within the initial limit			
Damp heat (Steady State)	+60 °C, 90 % to 95 %, 1000 h, No-applied voltage				
	Capacitance change	Within $\pm$ 20 % of the initial value			
	tan $\delta$	$\leq$ 150 % of the initial limit			
	DC leakage current	Within the initial limit (after voltage processing)			

### Marking

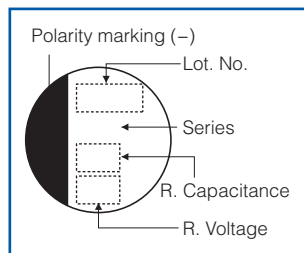

### Dimensions (not to scale)

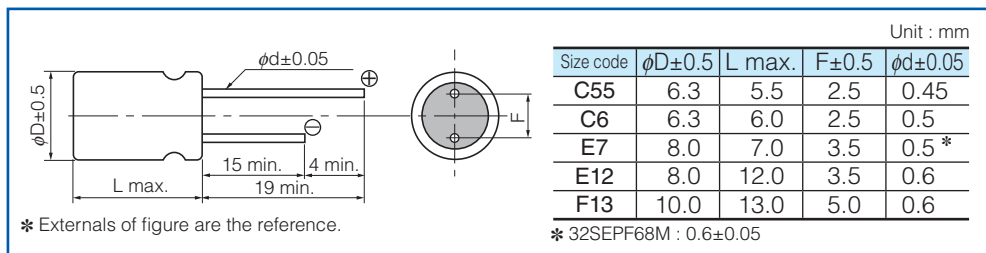

### Characteristics list

Series	Rated voltage (V.DC)	Rated capacitance ( $\mu$ F)	Case size (mm)		Size code	Specifications				Part number
			$\phi$ D	L		Ripple current* <sup>1</sup> (mAr.m.s.)	ESR* <sup>2</sup> (m $\Omega$ max.)	tan $\delta$ * <sup>3</sup>	LC* <sup>4</sup> ( $\mu$ A)	
SEPF	16	150	6.3	5.5	C55	2590	30	0.12	480	16SEPF150M
		180	6.3	6.0	C6	3300	22	0.12	576	16SEPF180M
		270	8.0	7.0	E7	3300	22	0.12	864	16SEPF270M
		560	8.0	12.0	E12	4950	14	0.12	1792	16SEPF560M
		1000	10.0	13.0	F13	5400	12	0.12	3200	16SEPF1000M
	20	120	6.3	6.0	C6	3200	25	0.12	480	20SEPF120M
		180	8.0	7.0	E7	3200	25	0.12	720	20SEPF180M
		390	8.0	12.0	E12	4950	14	0.12	1560	20SEPF390M
		560	10.0	13.0	F13	5400	12	0.12	2240	20SEPF560M
		25	56	6.3	6.0	C6	2800	30	0.12	280
	82		8.0	7.0	E7	3000	28	0.12	410	25SEPF82M
	180		8.0	12.0	E12	4650	16	0.12	900	25SEPF180M
	330		10.0	13.0	F13	5000	14	0.12	1650	25SEPF330M
	32	22	6.3	5.5	C55	2400	35	0.12	140	32SEPF22M
		68	8.0	7.0	E7	3200	25	0.10	435	32SEPF68M
	35	22	6.3	6.0	C6	2600	35	0.12	154	35SEPF22M
39		8.0	7.0	E7	2800	30	0.12	273	35SEPF39M	
82		8.0	12.0	E12	4000	20	0.12	574	35SEPF82M	
120		10.0	13.0	F13	4400	18	0.12	840	35SEPF120M	

\*<sup>1</sup> Ripple current (100 kHz/ +105 °C), \*<sup>2</sup> ESR (100 kHz to 300 kHz/+20 °C) \*<sup>3</sup> tan  $\delta$  (120 Hz/+20 °C) \*<sup>4</sup> After 2 minutes

◆ Please refer to each page in this catalog for "Flow conditions" and "Taping specifications".

### Frequency correction factor for ripple current

Frequency	120 Hz $\leq$ f < 1 kHz	1 kHz $\leq$ f < 10 kHz	10 kHz $\leq$ f < 100 kHz	100 kHz $\leq$ f < 500 kHz
Coefficient	0.05	0.3	0.7	1

Design and specifications are each subject to change without notice. Ask factory for the current technical specifications before purchase and/or use.

Should a safety concern arise regarding this product, please be sure to contact us immediately.

## Radial Lead Type

# OS-CON

Series : **SEPC**



### Features

- Super low ESR (5 mΩ to 24 mΩ)
- Large capacitance (2700 μF max.)
- RoHS compliance, Halogen free

### Specifications

Size code	B9	C55	C6	C9	E7	E9	E12	E13	F13	
Category temperature range	-55 °C to +105 °C									
Rated voltage range (V.DC)	2.5	6.3	2.5 to 16		6.3 to 16	2.5 to 16	16	2.5 to 6.3	2.5 to 16	
Rated capacitance range (μF)	100 to 560	220	100 to 560	100 to 820	150 to 1000	180 to 1000	180 to 270	470 to 820	470 to 2700	
Capacitance tolerance	±20 % (120 Hz / + 20 °C)									
Leakage current	Please see the attached characteristics list									
Dissipation factor (tan δ)	Please see the attached characteristics list									
Endurance	+105 °C, 5000 h, rated voltage applied									
	Capacitance change	Within ±20 % of the initial value								
	tan δ	≤ 150 % of the initial limit								
	DC leakage current	Within the initial limit								
Damp heat (Steady State)	+60 °C, 90 % to 95 %, 1000 h, No-applied voltage									
	Capacitance change	Within ±20 % of the initial value								
	tan δ	≤ 150 % of the initial limit								
	DC leakage current	Within the initial limit (after voltage processing)								

### Marking

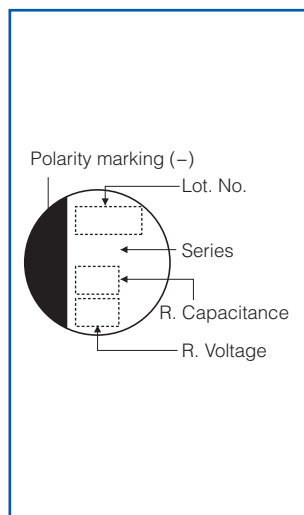

### Dimensions (not to scale)

E12, E13, F13 Size

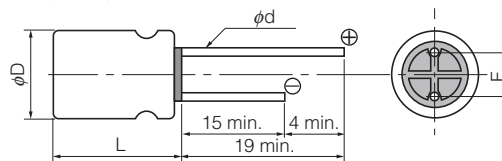

B9, C55, C6, C9, E7, E9 Size

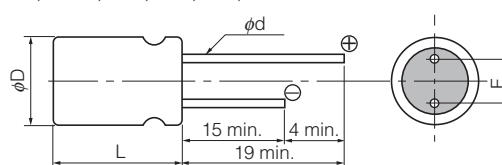

B9, C55, C6, C9, E7, E9 size flat rubber is used.

\* Externals of figure are the reference.

Size code	Unit : mm			
	φD±0.5	L max.	F±0.5	φd±0.05
B9	5.0	9.0	2.0	0.6
C55	6.3	5.5	2.5	0.45
C6	6.3	6.0	2.5	0.45 *1
C9	6.3	9.0	2.5	0.6
E7	8.0	7.0	3.5	0.6 *2
E9	8.0	9.0	3.5	0.6
E12	8.0	12.0	3.5	0.6
E13	8.0	13.0	3.5	0.6
F13	10.0	13.0	5.0	0.6

\*1 2SEPC390M, 2SEPC560M : 0.5±0.05

\*2 16SEPC150MD, 10SEPC270M : 0.45±0.05

## Characteristics list

Series	Rated voltage (V.DC)	Rated capacitance (μF)	Case size (mm)		Size code	Specifications				Part number	
			φD	L		Ripple* <sup>1</sup> current (mA r.m.s.)	ESR* <sup>2</sup> (mΩ max.)	tan δ* <sup>3</sup>	LC* <sup>4</sup> (μA)		
SEPC	2.5	100	5.0	9.0	B9	4180	7	0.10	500	2SEPC100MZ	
		330	5.0	9.0		4180	7	0.10	500	2SEPC330MZ	
		390	6.3	6.0	C6	3900	10	0.12	500	2SEPC390M	
		470	5.0	9.0	B9	4180	7	0.10	500	2SEPC470MZ	
		560	5.0	9.0		4180	7	0.10	500	2SEPC560MZ	
			6.3	6.0	C6	3900	10	0.12	500	2SEPC560M	
			6.3	9.0	C9	5600	7	0.10	500	2SEPC560MW	
		820	8.0	9.0	E9	4700	8	0.10	280	2SEPC560MX	
			6.3	9.0	C9	5600	7	0.10	500	2SEPC820MW	
			8.0	7.0	E7	5300	8	0.10	500	2SEPC820MD	
			8.0	9.0	E9	6100	7	0.10	500	2SEPC820MX	
			8.0	9.0		7200	5	0.10	500	2SEPC820MY	
		8.0	13.0	E13	6100	7	0.10	500	2R5SEPC820M		
	1000	8.0	9.0	E9	6100	7	0.10	500	2SEPC1000MX		
	2700	10.0	13.0	F13	5560	10	0.10	1350	2SEPC2700M		
	4.0	560	6.3	9.0	C9	5600	7	0.10	500	4SEPC560MW	
			8.0	9.0	E9	6100	7	0.10	500	4SEPC560MX	
			8.0	13.0	E13	6100	7	0.10	500	4SEPC560M	
		680	8.0	13.0		6100	7	0.10	544	4SEPC680M	
		820	10.0	13.0	F13	6640	7	0.10	656	4SEPC820M	
	6.3	220	6.3	5.5	C55	2980	18	0.12	280	6SEPC220M	
			6.3	9.0	C9	5600	7	0.10	592	6SEPC470MW	
		470	8.0	9.0	E9	5700	8	0.10	592	6SEPC470MX	
			8.0	13.0	E13	5700	8	0.10	592	6SEPC470M	
			6.3	9.0	C9	5600	7	0.10	705	6SEPC560MW	
		560	8.0	9.0	E9	6100	7	0.10	705	6SEPC560MX	
			680	10.0	13.0	F13	6640	7	0.10	857	6SEPC680M
			1000	8.0	7.0	E7	3530	18	0.10	1260	6SEPC1000MD
	1500		10.0	13.0	F13	5560	10	0.10	1890	6SEPC1500M	
	10		270	8.0	7.0	E7	3220	22	0.12	500	10SEPC270MD
	16	100	6.3	6.0	C6	2490	24	0.10	320	16SEPC100M	
			6.3	9.0	C9	4680	10	0.10	500	16SEPC100MW	
		150	8.0	7.0	E7	3220	22	0.12	500	16SEPC150MD	
		180	8.0	9.0	E9	5000	10	0.10	576	16SEPC180MX	
			8.0	12.0	E12	4360	16	0.10	576	16SEPC180M	
		220	8.0	7.0	E7	4150	13	0.10	500	16SEPC220MD	
270		8.0	9.0	E9	5000	10	0.10	864	16SEPC270MX		
		8.0	12.0	E12	5000	11	0.10	864	16SEPC270M		
	470	10.0	13.0	F13	6100	10	0.10	1504	16SEPC470M		

\*1 Ripple current (100 kHz/ +105 °C), \*2 ESR (100 kHz to 300 kHz/+20 °C) \*3 tan δ (120 Hz/+20 °C) \*4 After 2 minutes  
 ◆ Please refer to each page in this catalog for "Flow conditions" and "Taping specifications".

## Frequency correction factor for ripple current

Frequency	120 Hz ≤ f < 1 kHz	1 kHz ≤ f < 10 kHz	10 kHz ≤ f < 100 kHz	100 kHz ≤ f < 500 kHz
Coefficient	0.05	0.3	0.7	1

## Radial Lead Type

# OS-CON



Series : **SEQP**

### Features

- High voltage (32 V.DC max.)
- 125 °C 1000 h
- RoHS compliance, Halogen free

### Specifications

Size code	C6	E7	F8	E12	F13
Category temperature range	-55 °C to +125 °C				
Rated voltage range	4 V.DC to 20 V.DC		4 V.DC to 32 V.DC		4 V.DC to 20 V.DC
Rated capacitance range	22 μF to 150 μF	6.8 μF to 330 μF	15 μF to 680 μF	18 μF to 560 μF	150 μF to 1200 μF
Capacitance tolerance	±20 % (120 Hz / + 20 °C)				
Leakage current	Please see the attached characteristics list				
Dissipation factor (tan δ)	Please see the attached characteristics list				
Endurance	+125 °C, 1000 h/+105 °C, 5000 h, rated voltage applied				
	Capacitance change	Within ±20 % of the initial value			
	tan δ	≤ 200 % of the initial limit			
	DC leakage current	Within the initial limit			
Damp heat (Steady State)	+60 °C, 90 % to 95 %, 1000 h, No-applied voltage				
	Capacitance change	Within ±20 % of the initial value			
	tan δ	≤ 150 % of the initial limit			
	DC leakage current	Within the initial limit (after voltage processing)			

### Marking

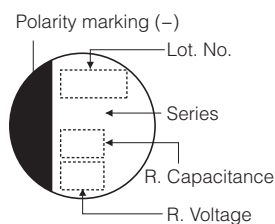

### Dimensions (not to scale)

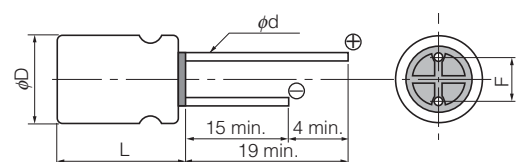

Unit : mm

Size code	φD±0.5	L max.	F±0.5	φd±0.05
C6	6.3	6.0	2.5	0.45
E7	8.0	7.0	3.5	0.45
F8	10.0	8.0	5.0	0.50
E12	8.0	12.0	3.5	0.60
F13	10.0	13.0	5.0	0.60

\* Externals of figure are the reference.

## Characteristics list

Series	Rated voltage (V.DC)	Rated capacitance (μF)	Case size (mm)		Size code	Specifications					Part number
			φD	L		Ripple current* <sup>1</sup> (mAr.m.s.)	Allowable* <sup>1</sup> ripple current (mAr.m.s.)	ESR* <sup>2</sup> (mΩ max.)	tan δ* <sup>3</sup>	LC* <sup>4</sup> (μA)	
SEQP	4.0	150	6.3	6.0	C6	572	1810	40	0.12	300	4SEQP150M
		330	8.0	7.0	E7	810	2560	35	0.12	660	4SEQP330M
		560	8.0	12.0	E12	1430	4520	13	0.15	448	4SEQP560M
		680	10.0	8.0	F8	1170	3700	25	0.12	544	4SEQP680M
		1200	10.0	13.0	F13	1721	5440	12	0.18	960	4SEQP1200M
	6.3	82	6.3	6.0	C6	537	1700	45	0.12	258	6SEQP82M
		150	8.0	7.0	E7	810	2560	35	0.12	472	6SEQP150M
		330	10.0	8.0	F8	1170	3700	25	0.12	416	6SEQP330M
		470	8.0	12.0	E12	1332	4210	15	0.15	592	6SEQP470M
		820	10.0	13.0	F13	1721	5440	12	0.15	775	6SEQP820M
	10	56	6.3	6.0	C6	537	1700	45	0.12	280	10SEQP56M
		120	8.0	7.0	E7	810	2560	35	0.12	600	10SEQP120M
		270	10.0	8.0	F8	1170	3700	25	0.12	540	10SEQP270M
		330	8.0	12.0	E12	1250	3950	17	0.15	660	10SEQP330M
		560	10.0	13.0	F13	1655	5230	13	0.15	840	10SEQP560M
	16	39	6.3	6.0	C6	512	1620	50	0.10	312	16SEQP39M
		82	8.0	7.0	E7	670	2120	40	0.12	656	16SEQP82M
		150	10.0	8.0	F8	955	3020	30	0.12	480	16SEQP150M
		180	8.0	12.0	E12	1151	3640	20	0.15	576	16SEQP180M
		330	10.0	13.0	F13	1493	4720	16	0.15	792	16SEQP330M
	20	22	6.3	6.0	C6	458	1450	60	0.10	220	20SEQP22M
		47	8.0	7.0	E7	598	1890	45	0.12	470	20SEQP47M
		68	10.0	8.0	F8	759	2400	40	0.12	272	20SEQP68M
		100	8.0	12.0	E12	1050	3320	24	0.15	400	20SEQP100M
150		10.0	13.0	F13	1367	4320	20	0.15	600	20SEQP150M	
32	6.8	8.0	7.0	E7	440	1400	100	0.10	44	32SEQP6R8M	
	15	10.0	8.0	F8	560	1800	80	0.10	96	32SEQP15M	
	18	8.0	12.0	E12	790	2500	50	0.12	115	32SEQP18M	

\*1 Ripple current (100 kHz/ +105 °C < Tx ≤ 125 °C), Allowable ripple current (100 kHz / Tx ≤ 105 °C)

\*2 ESR (100 kHz to 300 kHz/+20 °C) \*3 tan δ (120 Hz/+20 °C) \*4 After 2 minutes

◆ Please refer to each page in this catalog for "Flow conditions" and "Taping specifications".

## Frequency correction factor for ripple current

Frequency	120 Hz ≤ f < 1 kHz	1 kHz ≤ f < 10 kHz	10 kHz ≤ f < 100 kHz	100 kHz ≤ f < 500 kHz
Coefficient	0.05	0.3	0.7	1

## Radial Lead Type

# OS-CON



Series : **SEP**

### Features

- Standard
- 105 °C 3000 h
- RoHS compliance, Halogen free

### Specifications

Size code	C6	E7	F8	E12	F13
Category temperature range	-55 °C to +105 °C				
Rated voltage range	4 V.DC to 20 V.DC			2.5 V.DC to 20 V.DC	
Rated capacitance range	22 μF to 150 μF	33 μF to 330 μF	56 μF to 680 μF	100 μF to 680 μF	150 μF to 1500 μF
Capacitance tolerance	±20 % (120 Hz / + 20 °C)				
Leakage current	Please see the attached characteristics list				
Dissipation factor (tan δ)	Please see the attached characteristics list				
Endurance	+105 °C, 3000 h, rated voltage applied (2.5 V.DC 2000 h applied)				
	Capacitance change	Within ±20 % of the initial value			
	tan δ	≤ 150 % of the initial limit			
	DC leakage current	Within the initial limit			
Damp heat (Steady State)	+60 °C, 90 % to 95 %, 1000 h, No-applied voltage				
	Capacitance change	Within ±20 % of the initial value			
	tan δ	≤ 150 % of the initial limit			
	DC leakage current	Within the initial limit (after voltage processing)			

### Marking

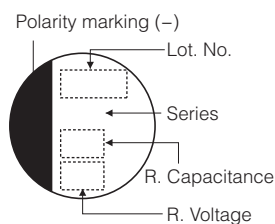

### Dimensions (not to scale)

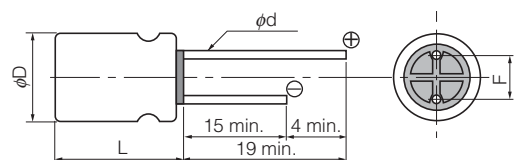

Unit : mm

Size code	φD±0.5	L max.	F±0.5	φd±0.05
C6	6.3	6.0	2.5	0.45
E7	8.0	7.0	3.5	0.45
F8	10.0	8.0	5.0	0.50
E12	8.0	12.0	3.5	0.60
F13	10.0	13.0	5.0	0.60

\* Externals of figure are the reference.

## Characteristics list

Series	Rated voltage (V.DC)	Rated capacitance (μF)	Case size (mm)		Size code	Specifications				Part number
			φD	L		Ripple* <sup>1</sup> current (mA r.m.s.)	ESR* <sup>2</sup> (mΩ max.)	tan δ* <sup>3</sup>	LC* <sup>4</sup> (μA)	
SEP	2.5	680	8.0	12.0	E12	4520	13	0.15	340	2R5SEP680M
		1500	10.0	13.0	F13	5440	12	0.18	750	2R5SEP1500M
	4.0	100	6.3	6.0	C6	1810	40	0.12	200	4SEP100M
		150	6.3	6.0		1810	40	0.12	300	4SEP150M
		220	8.0	7.0	E7	2560	35	0.12	440	4SEP220M
		330	8.0	7.0		2560	35	0.12	660	4SEP330M
		470	10.0	8.0	F8	3700	25	0.12	376	4SEP470M
		560	8.0	12.0	E12	4520	13	0.15	448	4SEP560M
		680	10.0	8.0	F8	3700	25	0.12	544	4SEP680M
		1200	10.0	13.0	F13	5440	12	0.18	960	4SEP1200M
	6.3	82	6.3	6.0	C6	1700	45	0.12	258	6SEP82M
		150	8.0	7.0	E7	2560	35	0.12	472	6SEP150M
		330	10.0	8.0	F8	3700	25	0.12	416	6SEP330M
		470	8.0	12.0	E12	4210	15	0.15	592	6SEP470M
		820	10.0	13.0	F13	5440	12	0.15	775	6SEP820M
	10	56	6.3	6.0	C6	1700	45	0.12	280	10SEP56M
		120	8.0	7.0	E7	2560	35	0.12	600	10SEP120M
		270	10.0	8.0	F8	3700	25	0.12	540	10SEP270M
		330	8.0	12.0	E12	3950	17	0.15	660	10SEP330M
		560	10.0	13.0	F13	5230	13	0.15	840	10SEP560M
	16	39	6.3	6.0	C6	1620	50	0.10	312	16SEP39M
		82	8.0	7.0	E7	2120	40	0.12	656	16SEP82M
		150	10.0	8.0	F8	3020	30	0.12	480	16SEP150M
		180	8.0	12.0	E12	3640	20	0.15	576	16SEP180M
		330	10.0	13.0	F13	4720	16	0.15	792	16SEP330M
	20	22	6.3	6.0	C6	1450	60	0.10	220	20SEP22M
		33	8.0	7.0	E7	1890	45	0.12	330	20SEP33M
		47	8.0	7.0		1890	45	0.12	470	20SEP47M
		56	10.0	8.0		F8	2400	40	0.12	224
		68	10.0	8.0	2400		40	0.12	272	20SEP68M
100		10.0	8.0	2570	35		0.12	400	20SEP100MX	
		8.0	12.0	E12	3320	24	0.15	400	20SEP100M	
150		10.0	13.0	F13	4320	20	0.15	600	20SEP150M	

\*1 Ripple current (100 kHz/ +105 °C), \*2 ESR (100 kHz to 300 kHz/+20 °C) \*3 tan δ (120 Hz/+20 °C) \*4 After 2 minutes

◆ Please refer to each page in this catalog for "Flow conditions" and "Taping specifications".

## Frequency correction factor for ripple current

Frequency	120 Hz ≤ f < 1 kHz	1 kHz ≤ f < 10 kHz	10 kHz ≤ f < 100 kHz	100 kHz ≤ f < 500 kHz
Coefficient	0.05	0.3	0.7	1



### CAUTION AND WARNING

1. The electronic components contained in this catalog are designed and produced for use in home electric appliances, office equipment, information equipment, communications equipment, and other general purpose electronic devices.  
Before use of any of these components for equipment that requires a high degree of safety, such as medical instruments, aerospace equipment, disaster-prevention equipment, security equipment, vehicles (automobile, train, vessel), please be sure to contact our sales representative corporation.
2. When applying one of these components for equipment requiring a high degree of safety, no matter what sort of application it might be, be sure to install a protective circuit or redundancy arrangement to enhance the safety of your equipment. In addition, please carry out the safety test on your own responsibility.
3. When using our products, no matter what sort of equipment they might be used for, be sure to make a written agreement on the specifications with us in advance.
4. Technical information contained in this catalog is intended to convey examples of typical performances and or applications and is not intended to make any warranty with respect to the intellectual property rights or any other related rights of our company or any third parties nor grant any license under such rights.
5. In order to export products in this catalog, the exporter may be subject to the export license requirement under the Foreign Exchange and Foreign Trade Law of Japan.
6. No ozone-depleting substances (ODSs) under the Montreal Protocol are used in the manufacturing processes of Automotive & Industrial Systems Company, Panasonic Corporation.

● Please contact

● Factory

Device Solutions Business Division  
Industrial Solutions Company

**Panasonic**<sup>®</sup>

1006 Kadoma, Kadoma City, Osaka 571-8506,  
JAPAN

The information in this catalog is valid as of April 2019.