

# Dual General Purpose Transistors

These transistors are designed for general purpose amplifier applications. They are housed in the SOT-363/SC-88 which is designed for low power surface mount applications.

We declare that the material of product compliance with RoHS requirements.

S- Prefix for Automotive and Other Applications Requiring Unique Site and Control Change Requirements; AEC-Q101 Qualified and PPAP Capable.

- Device Marking:  
 (S-)LBC856ADW1T1G= 3A  
 (S-)LBC856BDW1T1G= 3B  
 (S-)LBC857BDW1T1G= 3F  
 (S-)LBC857CDW1T1G= 3G  
 (S-)LBC858BDW1T1G= 3K  
 (S-)LBC858CDW1T1G = 3L

**LBC85\*\* DW1T1G**  
**S-LBC85\*\* DW1T1G**

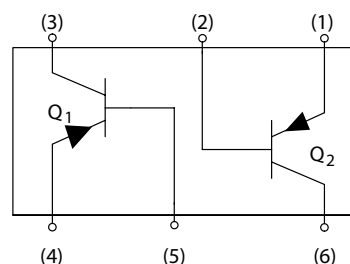
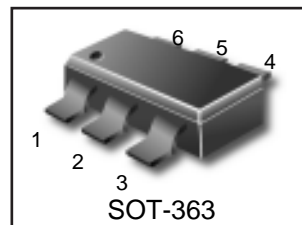

### MAXIMUM RATINGS

Rating	Symbol	BC856	BC857	BC858	Unit
Collector-Emitter Voltage	$V_{CEO}$	-65	-45	-30	V
Collector-Base Voltage	$V_{CBO}$	-80	-50	-30	V
Emitter-Base Voltage	$V_{EBO}$	-5.0	-5.0	-5.0	V
Collector Current – Continuous	$I_C$	-100	-100	-100	mAdc

### THERMAL CHARACTERISTICS

Characteristic	Symbol	Max	Unit
Total Device Dissipation Per Device FR-5 Board (Note 1.) $T_A = 25^\circ\text{C}$ Derate Above $25^\circ\text{C}$	$P_D$	380 250	mW
Thermal Resistance, Junction to Ambient	$R_{\theta JA}$	328	$^\circ\text{C/W}$
Junction and Storage Temperature Range	$T_J, T_{stg}$	-55 to +150	$^\circ\text{C}$

1. FR-5 = 1.0 x 0.75 x 0.062 in

### DEVICE MARKING

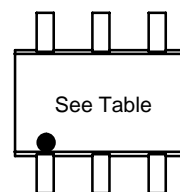

### ORDERING INFORMATION

Device	Shipping
LBC85*BDW1T1G	3000/Tape & Reel
LBC85*BDW1T3G	10000/Tape & Reel

**LBC856ADW1T1G, LBC856BDW1T1G, LBC857BDW1T1G, LBC857CDW1T1G,**  
**LBC858BDW1T1G, LBC858CDW1T1G**  
**S-LBC856ADW1T1G, S-LBC856BDW1T1G, S-LBC857BDW1T1G, S-LBC857CDW1T1G,**  
**S-LBC858BDW1T1G, S-LBC858CDW1T1G**

**ELECTRICAL CHARACTERISTICS** ( $T_A = 25^\circ\text{C}$  unless otherwise noted)

Characteristic	Symbol	Min	Typ	Max	Unit	
<b>OFF CHARACTERISTICS</b>						
Collector–Emitter Breakdown Voltage ( $I_C = -10\text{ mA}$ )	LBC856 Series LBC857 Series LBC858 Series	$V_{(BR)CEO}$	-65 -45 -30	- - -	- - -	V
Collector–Emitter Breakdown Voltage ( $I_C = -10\text{ }\mu\text{A}$ , $V_{EB} = 0$ )	LBC856 Series LBC857 Series LBC858 Series	$V_{(BR)CES}$	-80 -50 -30	- - -	- - -	V
Collector–Base Breakdown Voltage ( $I_C = -10\text{ }\mu\text{A}$ )	LBC856 Series LBC857 Series LBC858 Series	$V_{(BR)CBO}$	-80 -50 -30	- - -	- - -	V
Emitter–Base Breakdown Voltage ( $I_E = -1.0\text{ }\mu\text{A}$ )	LBC856 Series LBC857 Series LBC858 Series	$V_{(BR)EBO}$	-5.0 -5.0 -5.0	- - -	- - -	V
Collector Cutoff Current ( $V_{CB} = -30\text{ V}$ ) ( $V_{CB} = -30\text{ V}$ , $T_A = 150^\circ\text{C}$ )		$I_{CBO}$	- -	- -	-15 -4.0	nA $\mu\text{A}$
<b>ON CHARACTERISTICS</b>						
DC Current Gain ( $I_C = -10\text{ }\mu\text{A}$ , $V_{CE} = -5.0\text{ V}$ )	LBC856A LBC856B, LBC857B, LBC858B LBC857C, LBC858C	$h_{FE}$	- - -	90 150 270	- - -	-
( $I_C = -2.0\text{ mA}$ , $V_{CE} = -5.0\text{ V}$ )	LBC856A LBC856B, LBC857B, LBC858B LBC857C, LBC858C		125 220 420	180 290 520	250 475 800	
Collector–Emitter Saturation Voltage ( $I_C = -10\text{ mA}$ , $I_B = -0.5\text{ mA}$ ) ( $I_C = -100\text{ mA}$ , $I_B = -5.0\text{ mA}$ )		$V_{CE(sat)}$	- -	- -	-0.3 -0.65	V
Base–Emitter Saturation Voltage ( $I_C = -10\text{ mA}$ , $I_B = -0.5\text{ mA}$ ) ( $I_C = -100\text{ mA}$ , $I_B = -5.0\text{ mA}$ )		$V_{BE(sat)}$	- -	-0.7 -0.9	- -	V
Base–Emitter On Voltage ( $I_C = -2.0\text{ mA}$ , $V_{CE} = -5.0\text{ V}$ ) ( $I_C = -10\text{ mA}$ , $V_{CE} = -5.0\text{ V}$ )		$V_{BE(on)}$	-0.6 -	- -	-0.75 -0.82	V
<b>SMALL–SIGNAL CHARACTERISTICS</b>						
Current–Gain – Bandwidth Product ( $I_C = -10\text{ mA}$ , $V_{CE} = -5.0\text{ Vdc}$ , $f = 100\text{ MHz}$ )		$f_T$	100	-	-	MHz
Output Capacitance ( $V_{CB} = -10\text{ V}$ , $f = 1.0\text{ MHz}$ )		$C_{ob}$	-	-	4.5	pF
Noise Figure ( $I_C = -0.2\text{ mA}$ , $V_{CE} = -5.0\text{ Vdc}$ , $R_S = 2.0\text{ k}\Omega$ , $f = 1.0\text{ kHz}$ , $BW = 200\text{ Hz}$ )		NF	-	-	10	dB

LBC856ADW1T1G, LBC856BDW1T1G, LBC857BDW1T1G, LBC857CDW1T1G,  
 LBC858BDW1T1G, LBC858CDW1T1G  
 S-LBC856ADW1T1G, S-LBC856BDW1T1G, S-LBC857BDW1T1G, S-LBC857CDW1T1G,  
 S-LBC858BDW1T1G, S-LBC858CDW1T1G

TYPICAL CHARACTERISTICS – LBC856

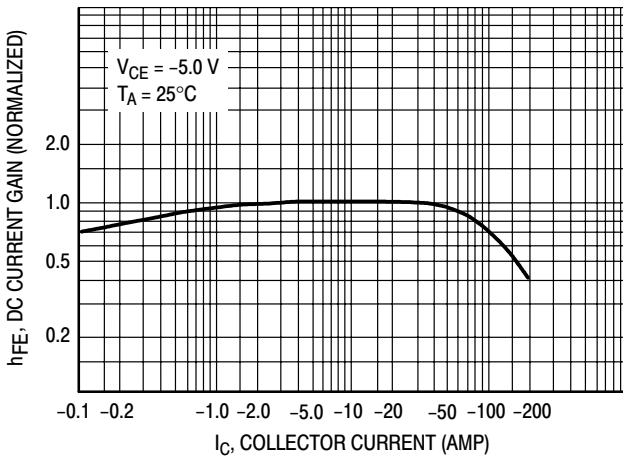

Figure 1. DC Current Gain

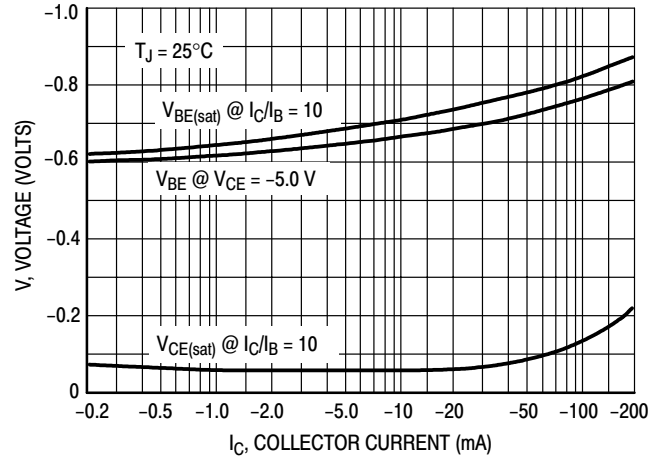

Figure 2. "On" Voltage

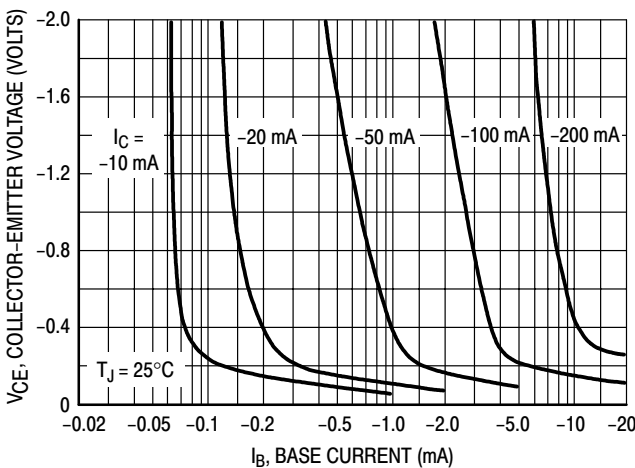

Figure 3. Collector Saturation Region

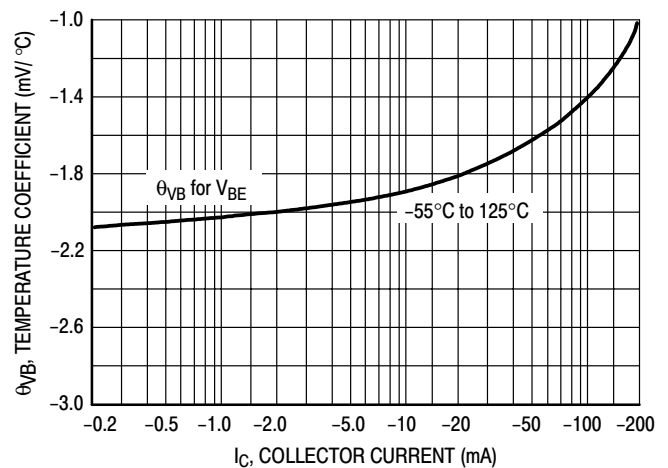

Figure 4. Base-Emitter Temperature Coefficient

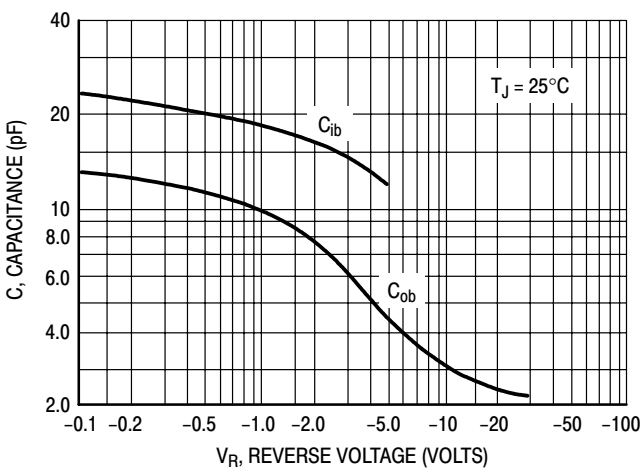

Figure 5. Capacitance

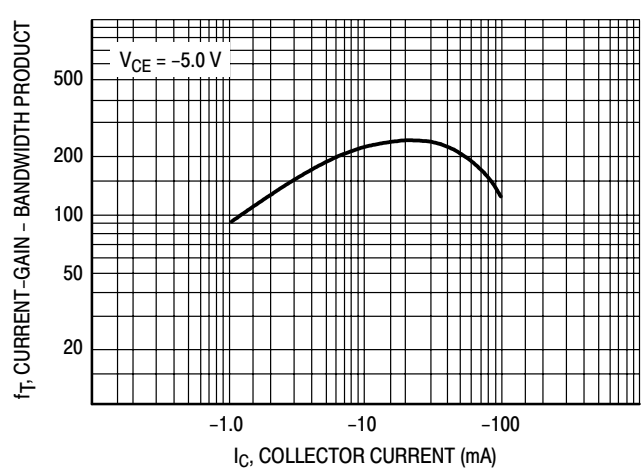

Figure 6. Current-Gain - Bandwidth Product

LBC856ADW1T1G, LBC856BDW1T1G, LBC857BDW1T1G, LBC857CDW1T1G,  
 LBC858BDW1T1G, LBC858CDW1T1G,  
 S-LBC856ADW1T1G, S-LBC856BDW1T1G, S-LBC857BDW1T1G, S-LBC857CDW1T1G,  
 S-LBC858BDW1T1G, S-LBC858CDW1T1G

TYPICAL CHARACTERISTICS – LBC857/LBC858

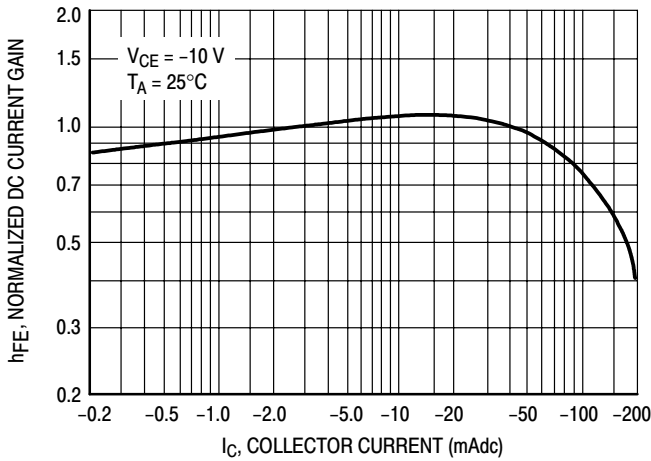

Figure 7. Normalized DC Current Gain

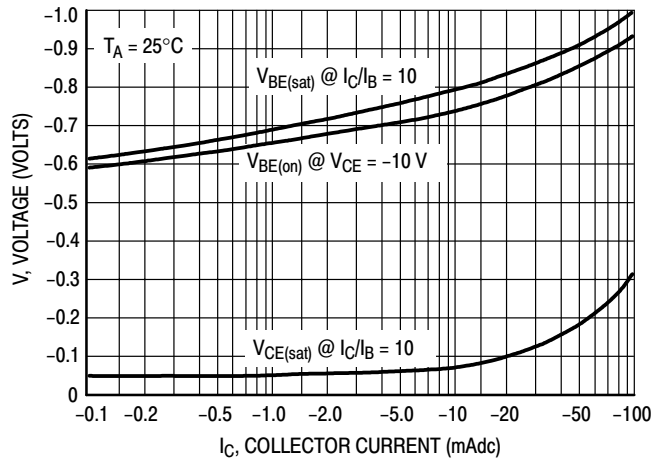

Figure 8. "Saturation" and "On" Voltages

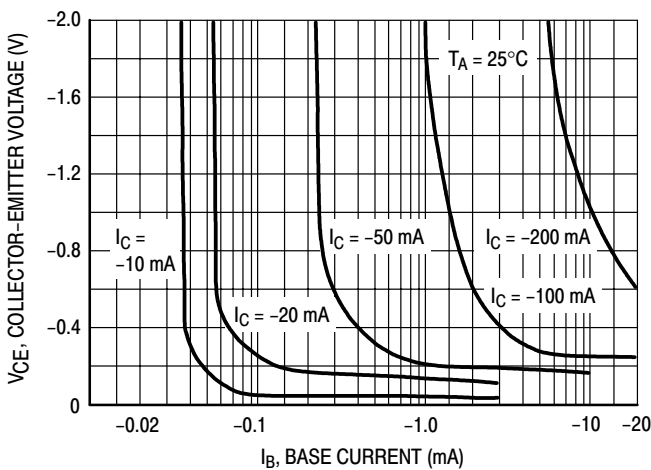

Figure 9. Collector Saturation Region

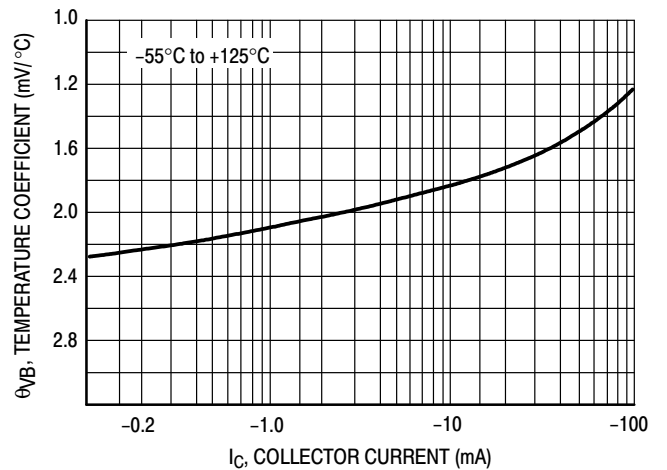

Figure 10. Base-Emitter Temperature Coefficient

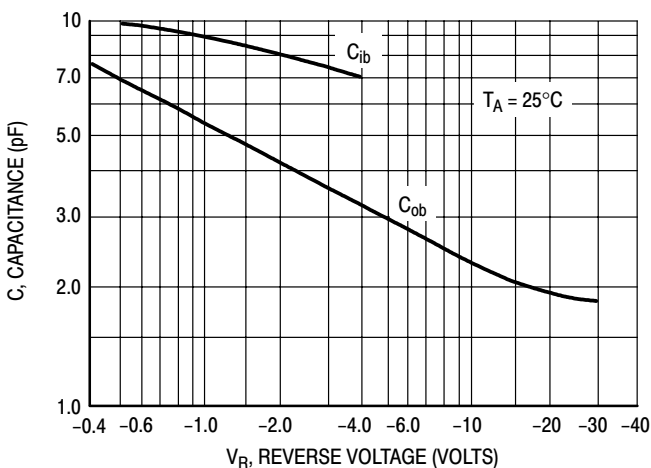

Figure 11. Capacitances

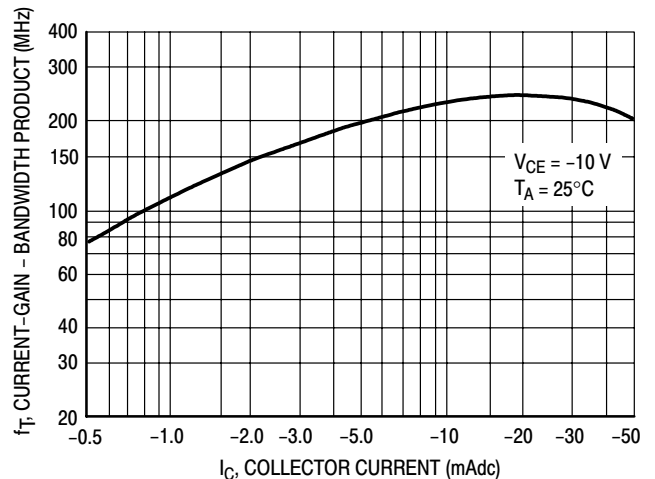

Figure 12. Current-Gain - Bandwidth Product

LBC856ADW1T1G, LBC856BDW1T1G, LBC857BDW1T1G, LBC857CDW1T1G,  
 LBC858BDW1T1G, LBC858CDW1T1G  
 S-LBC856ADW1T1G, S-LBC856BDW1T1G, S-LBC857BDW1T1G, S-LBC857CDW1T1G,  
 S-LBC858BDW1T1G, S-LBC858CDW1T1G

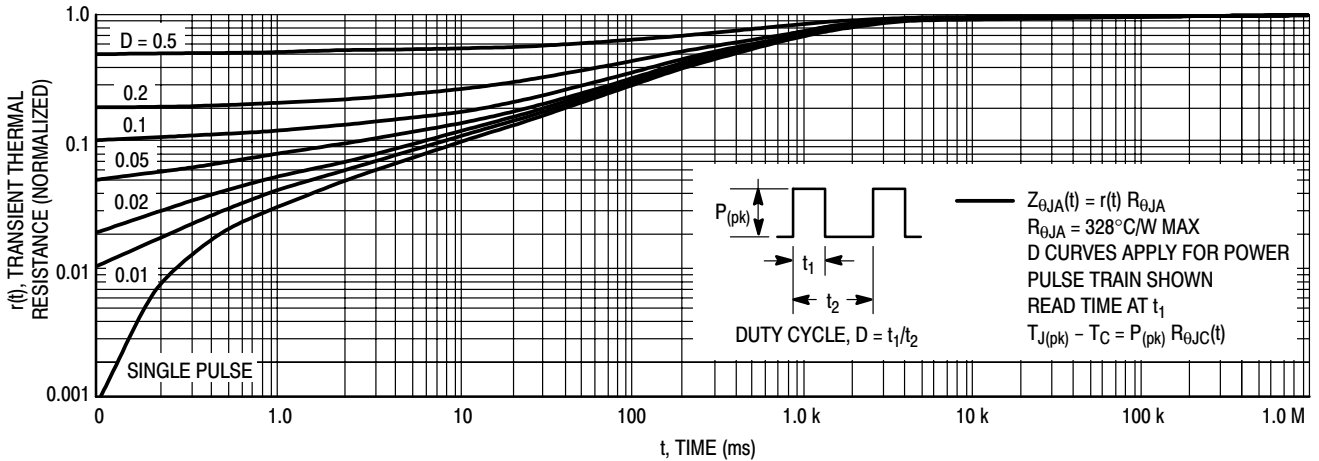

Figure 13. Thermal Response

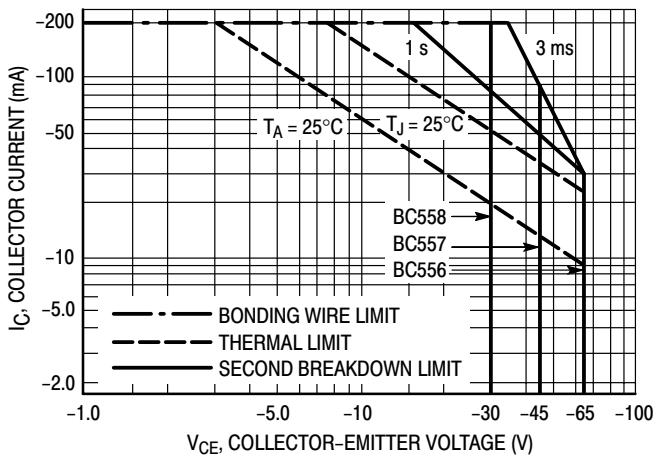

Figure 14. Active Region Safe Operating Area

The safe operating area curves indicate  $I_C$ - $V_{CE}$  limits of the transistor that must be observed for reliable operation. Collector load lines for specific circuits must fall below the limits indicated by the applicable curve.

The data of Figure 14 is based upon  $T_{J(pk)} = 150^\circ\text{C}$ ;  $T_C$  or  $T_A$  is variable depending upon conditions. Pulse curves are valid for duty cycles to 10% provided  $T_{J(pk)} \leq 150^\circ\text{C}$ .  $T_{J(pk)}$  may be calculated from the data in Figure 13. At high case or ambient temperatures, thermal limitations will reduce the power that can be handled to values less than the limitations imposed by the secondary breakdown.

LBC856ADW1T1G, LBC856BDW1T1G, LBC857BDW1T1G, LBC857CDW1T1G,  
 LBC858BDW1T1G, LBC858CDW1T1G  
 S-LBC856ADW1T1G, S-LBC856BDW1T1G, S-LBC857BDW1T1G, S-LBC857CDW1T1G,  
 S-LBC858BDW1T1G, S-LBC858CDW1T1G

SC-88/SOT-363

NOTES:

1. DIMENSIONING AND TOLERANCING PER ANSI Y14.5M, 1982.
2. CONTROLLING DIMENSION: INCH.

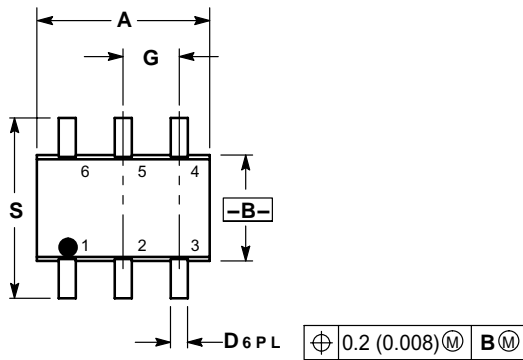

DIM	INCHES		MILLIMETERS	
	MIN	MAX	MIN	MAX
A	0.071	0.087	1.80	2.20
B	0.045	0.053	1.15	1.35
C	0.031	0.043	0.80	1.10
D	0.004	0.012	0.10	0.30
G	0.026 BSC		0.65 BSC	
H	---	0.004	---	0.10
J	0.004	0.010	0.10	0.25
K	0.004	0.012	0.10	0.30
N	0.008 REF		0.20 REF	
S	0.079	0.087	2.00	2.20

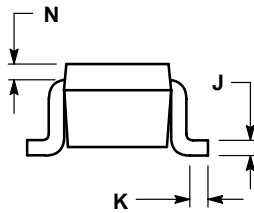
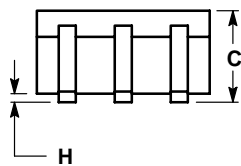

- PIN 1. EMITTER 2
- 2. BASE 2
- 3. COLLECTOR 1
- 4. EMITTER 1
- 5. BASE 1
- 6. COLLECTOR 2

