

SIR765-02

Photo Interrupter

The SIR765-02 is a photointerrupter consisting of GaAs IRED and phototransistor.

Features

- Fast response time
- High sensitivity
- Cut-off visible wavelength
- RoHS Compliance

Applications

- Copier
- Scanner
- Printer
- Non-contact switching

Dimensions (unit: mm)

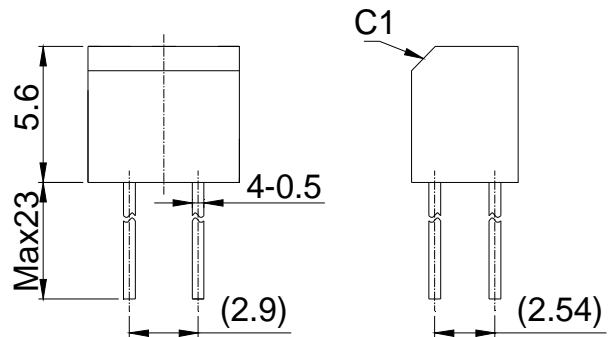
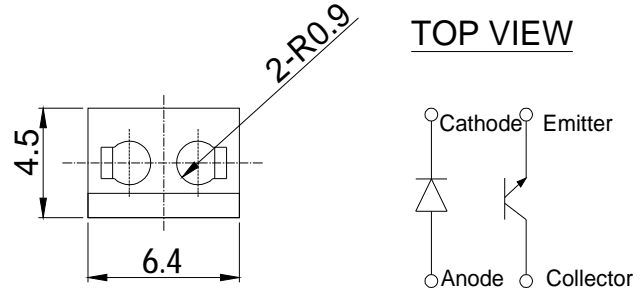

General Tolerance (±0.2)

Maximum Ratings

(Ta=25°C)

Item		Symbol	Rating	Unit
Input	Power dissipation	P_D	75	mW
	Forward current	I_F	50	mA
	Reverse voltage	V_R	5	V
Output	Collector power dissipation	P_C	75	mW
	Collector current	I_C	20	mA
	Collector-Emitter voltage	V_{CEO}	30	V
	Emitter-Collector voltage	V_{ECO}	5	V
Operating temperature ^{*1}		Topr.	-20 ~ +85	°C
Storage temperature ^{*1}		Tstg.	-30 ~ +85	°C
Soldering temperature ^{*2}		Tsol.	260	°C

*1. No icebond or dew.

*2. The soldering should be 1.2mm away from bottom of the holder t=within 3s

Photo Interrupter

SIR765-02

Electro-Optical Characteristics

(Ta=25°C)

Item		Symbol	Conditions	Min.	Typ.	Max.	Unit
Input	Forward voltage	V_F	$I_F=20\text{mA}$	-	1.2	1.4	V
	Reverse current	I_R	$V_R=5\text{V}$	-	-	10	μA
	Peak wavelength	λ_P	$I_F=20\text{mA}$	-	940	-	nm
Output	Dark current	I_{CEO}	$V_{CE}=10\text{V } E_V=0 \text{ lx}$	-	3	100	nA
	Peak SENS.Wavelength	λ_P	-	-	880	-	nm
Transfer characteristics	Light current *3	I_{CEL}	$I_F=10\text{mA } V_{CE}=5\text{V } d=5\text{mm}$	0.5	-	6.0	mA
	Leak current *4	I_{CEOD}	$I_F=10\text{mA } V_{CE}=5\text{V}$	-	-	20	μA
	C-E sat.voltage	$V_{CE(sat)}$	$I_F=20\text{mA } I_C=0.1\text{mA}$	-	0.15	0.4	V
	Rise time	tr	$I_C=100\mu\text{A } V_{CC}=5\text{V } R_L=100 \Omega$	-	10	-	μs
	Fall time	tf		-	10	-	μs

*3. d=5mm KODAK 90% Reflex Paper

*4. NO Reflector

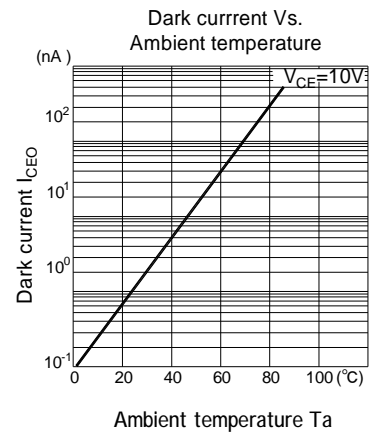
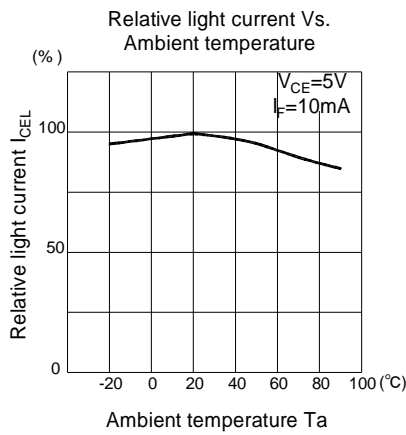
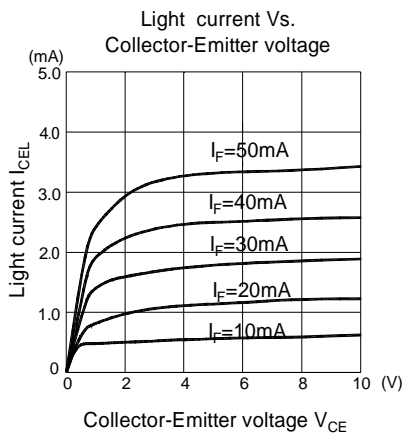
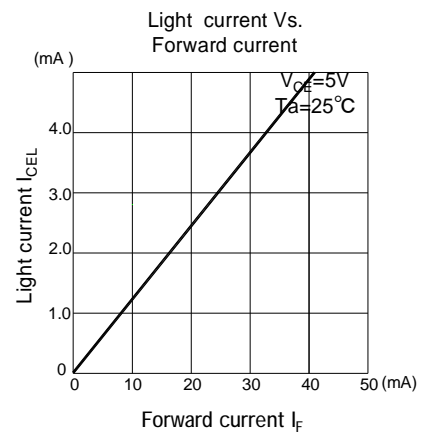
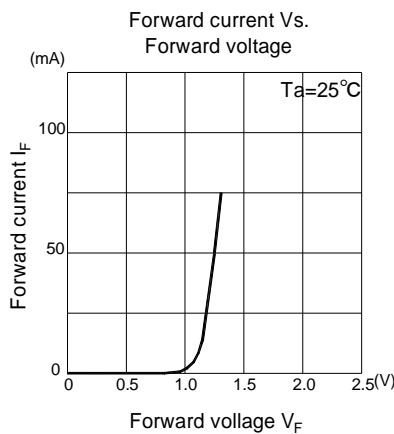
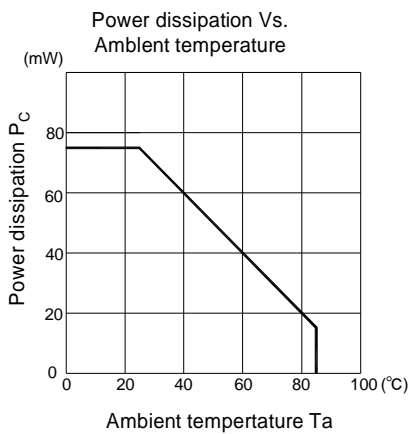

The contents of this data sheet are subject to change without advance notice for the purpose of improvement. When using this product, would you please refer to the latest specifications.

Photo Interrupter

SIR765-02

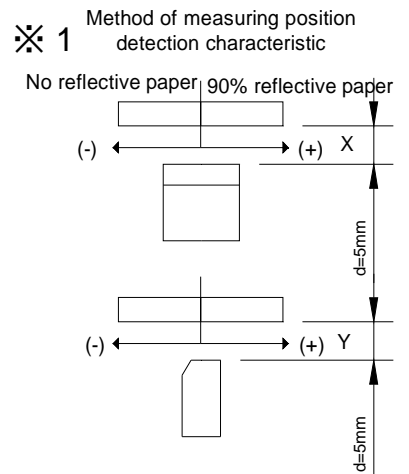
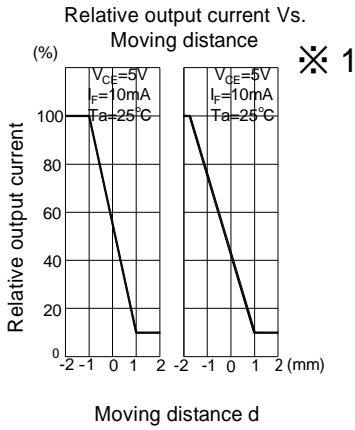
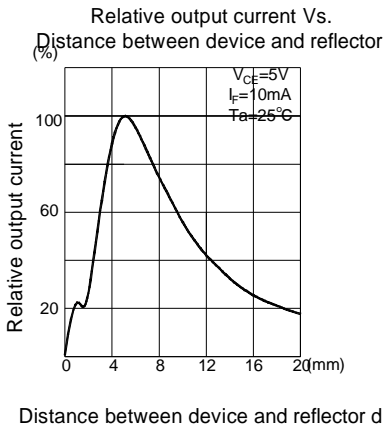
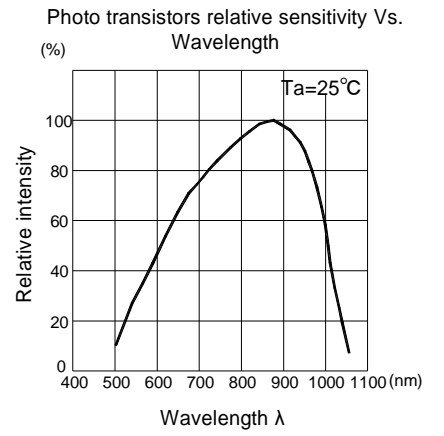
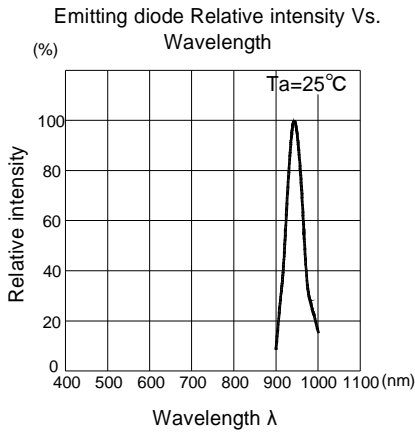
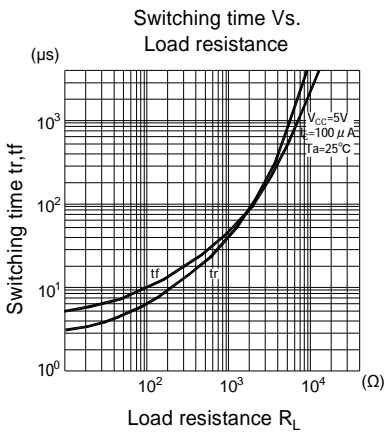

The contents of this data sheet are subject to change without advance notice for the purpose of improvement. When using this product, would you please refer to the latest specifications.

SIR765-02

Packing Specification

- 1.Fixed quantity (max 100pcs) of the products are packed into plastic bag
- 2.Five bags of the products are put into #1 box
- 3.Ten #1 boxes are put into #2 box and two #2 boxes are put into #3 box(max 10000pcs)
4. Packing slit is pasted on #3 box

