

1.Features

- n Advanced trench process technology
- n High density cell design for ultra low on-resistance
- n Fully characterized avalanche voltage and current

2.Applications

- n $V_{ds}=30V$
- n $R_{DS(ON)}=9.0m\Omega(\text{typ.}), V_{GS}@10V, I_{ds}@12A$
- n $R_{DS(ON)}=11.5m\Omega(\text{typ.}), V_{GS}@4.5V, I_{ds}@6A$

3. Pin configuration

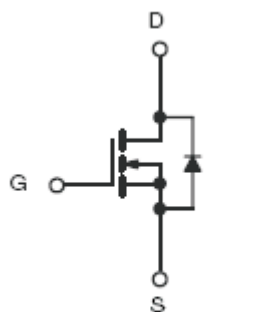
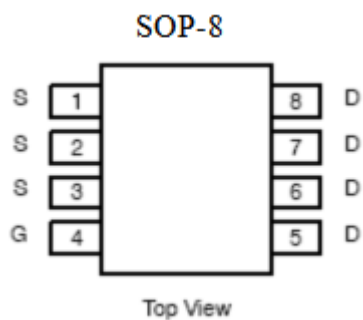

Pin	Function
1,2,3	Source
4	Gate
5,6,7,8	Drain

4. Maximum ratings and thermal characteristics

($T_A=25^\circ\text{C}$, unless otherwise notes)

Rating	Symbol	Value	Unit	
Drain-source voltage	V_{DS}	30	V	
Gate-source voltage	V_{GS}	± 20	V	
Continuous drain current	I_D	12	A	
Pulsed drain current ¹⁾	I_{DM}	48	A	
Maximum power dissipation	$T_A=25^\circ\text{C}$	P_D	3.1	W
	$T_A=75^\circ\text{C}$	P_D	2.0	W
Operating junction and storage temperature range	T_J/T_{STG}	-55 to 150	$^\circ\text{C}$	
Junction-to-case thermal resistance	$R_{\theta JC}$	40.3	$^\circ\text{C/W}$	
Junction-to ambient thermal resistance (PCB mount) ²⁾	$R_{\theta JA}$	59	$^\circ\text{C/W}$	

Note: Repetitive rating: pulse width limited by the maximum junction temperature

5. Ordering information

Part number	Package
KNE6303A	SOP-8

6. Typical application circuit

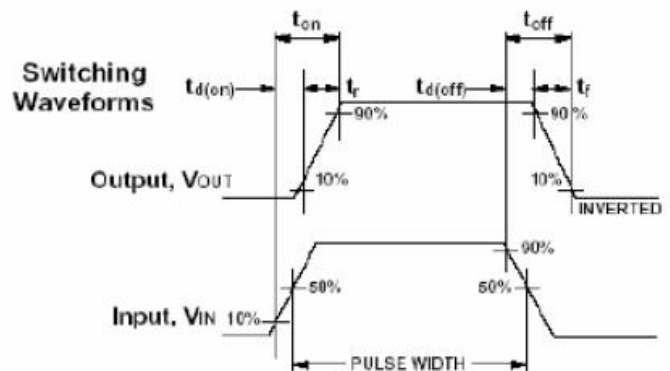
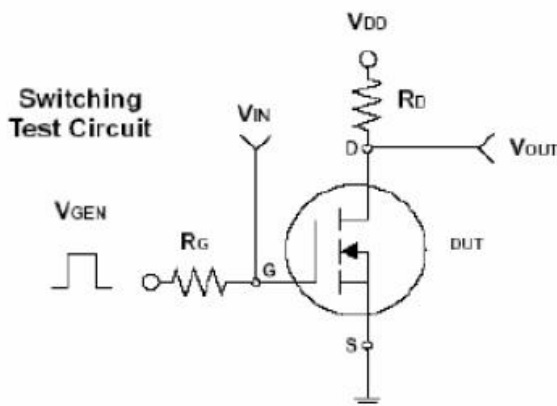

7. Electrical characteristics

(Ta=25°C, unless otherwise notes)

Parameter	Symbol	Test conditions	Min.	Typ.	Max.	Units
Static						
Drain-source breakdown voltage	BV_{DSS}	$V_{GS}=0V, I_D=250\mu A$	30	-	-	V
Drain-source on-state resistance	$R_{DS(ON)}$	$V_{GS}=4.5V, I_D=6A$	-	11.5	14.0	mΩ
		$V_{GS}=10V, I_D=12A$	-	8.0	10.0	mΩ
Gate threshold voltage	$V_{GS(th)}$	$V_{DS}=V_{GS}, I_D=-250\mu A$	1	1.8	3	V
Forward transconductance	G_{fs}	$V_{DS}=15V, I_D=6A$	-	12	-	S
Zero gate voltage drain current	I_{DSS}	$V_{DS}=25V, V_{GS}=0V$	-	-	1	μA
Gate-source forward leakage	I_{GSS}	$V_{GS}=\pm 20V, V_{DS}=0V$	-	-	±100	nA
Dynamic³⁾						
Total gate charge	Q_g	$I_D=35A$ $V_{DS}=15V$ $V_{GS}=10V$	-	10	-	nC
Gate-source charge	Q_{gs}		-	3.5	-	nC
Gate-drain ("miller") charge	Q_{gd}		-	3	-	nC
Turn-on delay time	$t_{d(off)}$	$V_{DD}=15V$ $I_D=1A$ $R_G=6\Omega$ $R_L=15\Omega$ $V_{GEN}=10V$	-	12	-	ns
Rise time	t_r		-	4	-	ns
Turn-off delay time	$t_{d(off)}$		-	32	-	ns
Fall time	t_f		-	6	-	ns
Input capacitance	C_{iss}	$V_{GS}=0V$ $V_{DS}=15V$ $f=1.0MHz$	-	1300	-	pF
Output capacitance	C_{oss}		-	270	-	pF
Reverse transfer capacitance	C_{rss}		-	145	-	pF

Source-drain diode

Parameter	Symbol	Test condition	Min.	Typ.	Max.	Units
Diode forward voltage	V_{SD}	$I_S=10A, V_{GS}=0V$	-	0.87	1.5	V
Max. diode forward current	I_S		-	-	12	A

Notes: Pulse width ≤ 300μs, duty cycle ≤ 2%

8. Test circuits and waveforms

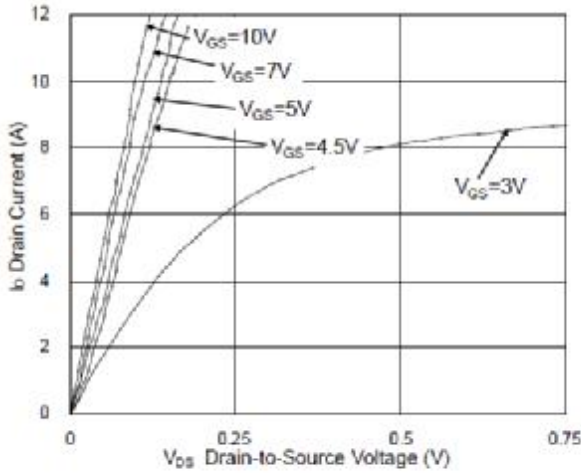

Fig.1 Typical Output Characteristics

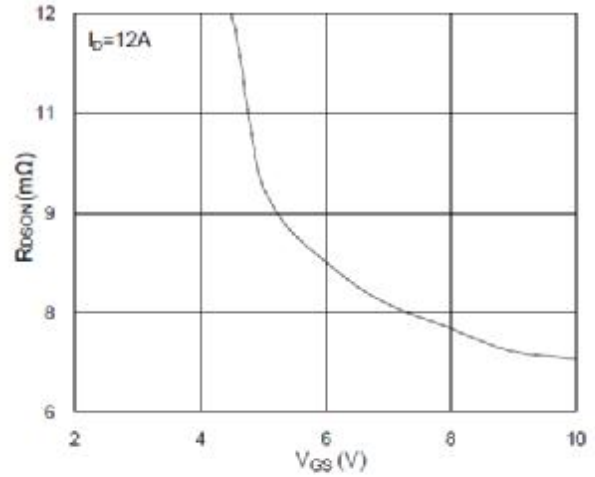

Fig.2 On-Resistance vs. G-S Voltage

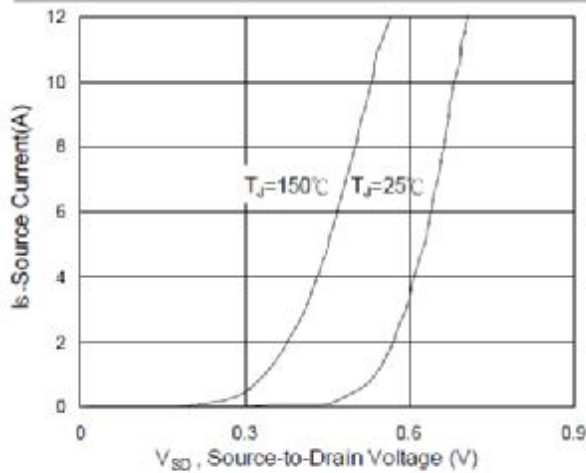

Fig.3 Forward Characteristics of Reverse

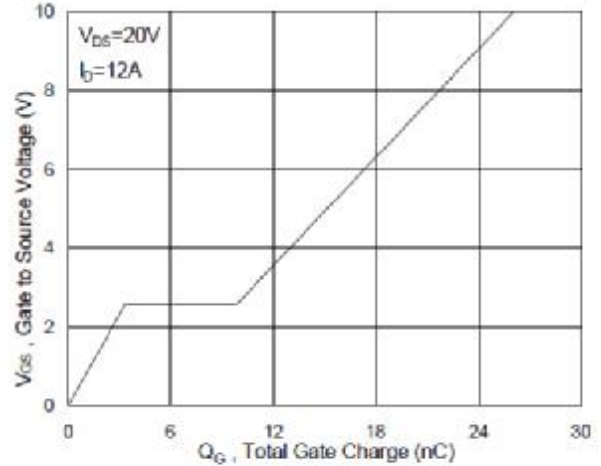

Fig.4 Gate-Charge Characteristics

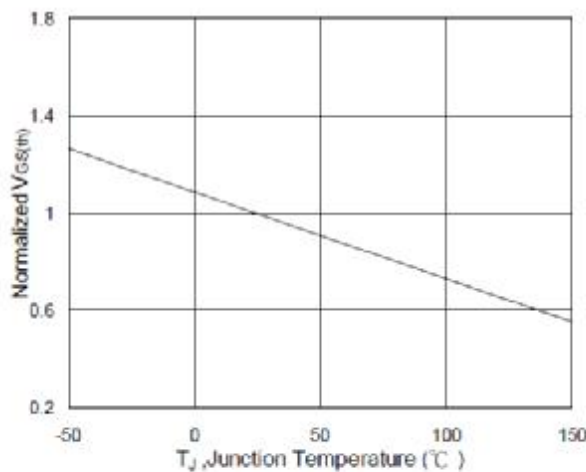

Fig.5 Normalized $V_{GS(th)}$ vs. T_J

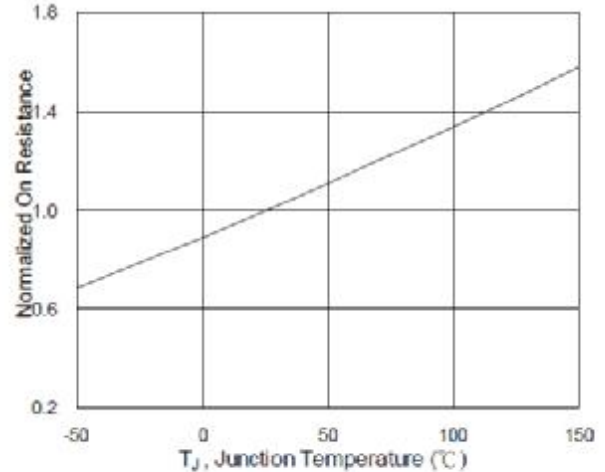

Fig.6 Normalized $R_{DS(on)}$ vs. T_J

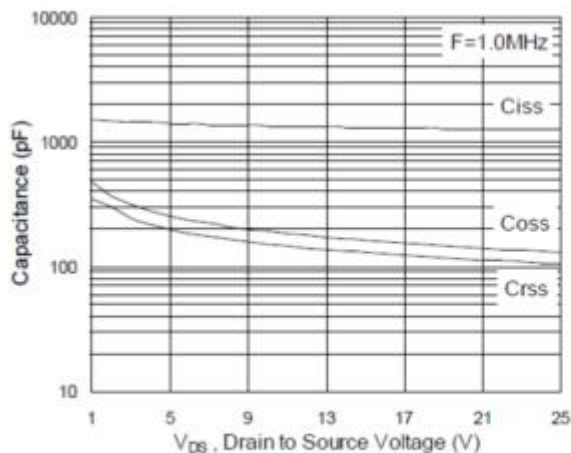

Fig.7 Capacitance

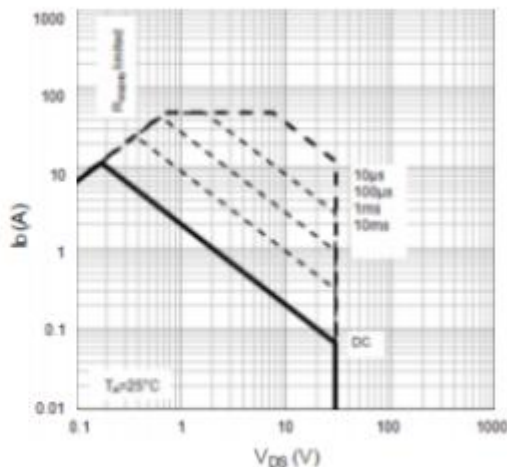

Fig.8 Safe Operating Area

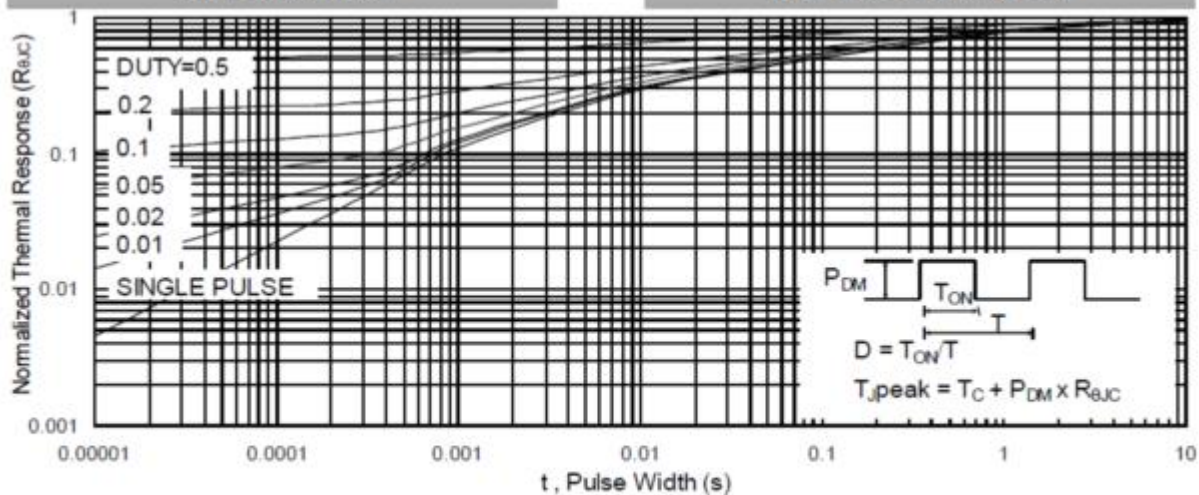

Fig.9 Normalized Maximum Transient Thermal Impedance

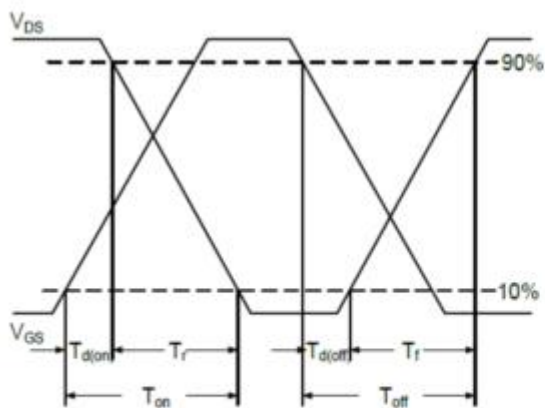

Fig.10 Switching Time Waveform

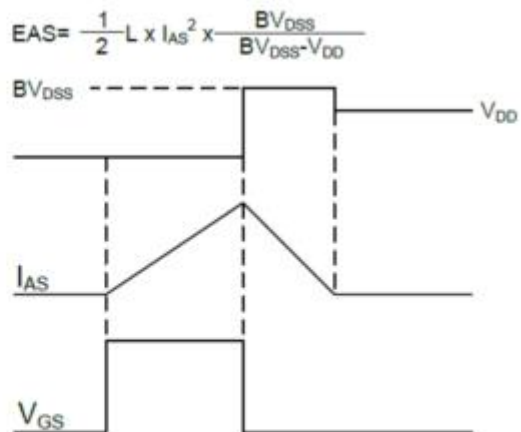

Fig.11 Unclamped Inductive Switching Waveform