

SOT-23 Plastic-Encapsulate Transistors

TRANSISTOR(PNP)

Features

- As complementary type, the NPN transistor MMBT3904 is Recommended
- Epitaxial planar die construction

Marking:

- 2A

Limiting Values (Absolute Maximum Rating)

Symbol	Parameter	Value	Unit
V_{CBO}	Collector-Base Voltage	-40	V
V_{CEO}	Collector-Emitter Voltage	-40	V
V_{EBO}	Emitter-Base Voltage	-5	V
I_C	Collector Current	-200	mA
P_C	Collector Power Dissipation	200	mW
$R_{\theta JA}$	Thermal Resistance From Junction To Ambient	625	$^{\circ}C/W$
T_j	Junction Temperature	150	$^{\circ}C$
T_{stg}	Storage Temperature	-55~+150	$^{\circ}C$

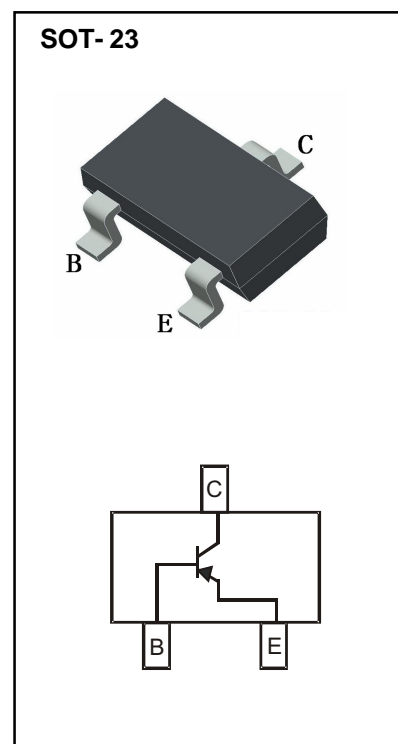

Electrical Characteristics (Ta=25 $^{\circ}C$ Unless otherwise specified)

Parameter	Symbol	Test conditions	MIN	MAX	UNIT
Collector-base breakdown voltage	$V_{(BR)CBO}$	$I_C = -10\mu A, I_E = 0$	-40		V
Collector-emitter breakdown voltage	$V_{(BR)CEO}$	$I_C = -1mA, I_B = 0$	-40		V
Emitter-base breakdown voltage	$V_{(BR)EBO}$	$I_E = -10\mu A, I_C = 0$	-5		V
Collector cut-off current	I_{CBO}	$V_{CB} = -40V, I_E = 0$		-100	nA
Collector cut-off current	I_{CEX}	$V_{CE} = -30V, V_{BE(off)} = -3V$		-50	nA
Emitter cut-off current	I_{EBO}	$V_{EB} = -5V, I_C = 0$		-100	nA
DC current gain	h_{FE1}	$V_{CE} = -1V, I_C = -10mA$	100	300	
	h_{FE2}	$V_{CE} = -1V, I_C = -50mA$	60		
	h_{FE3}	$V_{CE} = -1V, I_C = -100mA$	30		
Collector-emitter saturation voltage	$V_{CE(sat)1}$	$I_C = -50mA, I_B = -5mA$		-0.3	V
Base-emitter saturation voltage	$V_{BE(sat)}$	$I_C = -50mA, I_B = -5mA$		-0.95	V
Transition frequency	f_T	$V_{CE} = -20V, I_C = -10mA, f = 100MHz$	300		MHz
Delay Time	t_d	$V_{CC} = -3V, V_{BE} = -0.5V$		35	nS
Rise Time	t_r	$I_C = -10mA, I_{B1} = I_{B2} = -1mA$		35	nS
Storage Time	t_s	$V_{CC} = -3V, I_C = -10mA$		225	nS
Fall Time	t_f	$I_{B1} = I_{B2} = -1mA$		75	nS

CLASSIFICATION OF h_{FE}

HFE	100-300	
RANK	L	H
RANGE	100 - 200	200 - 300

Typical Characteristics

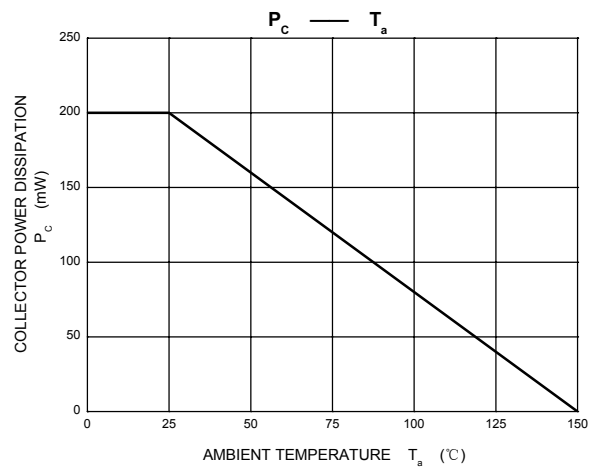
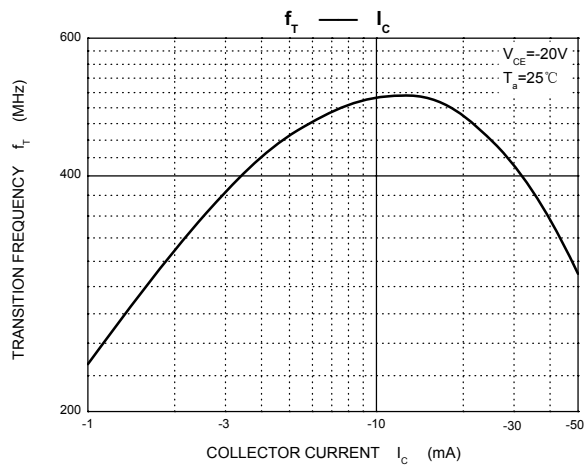
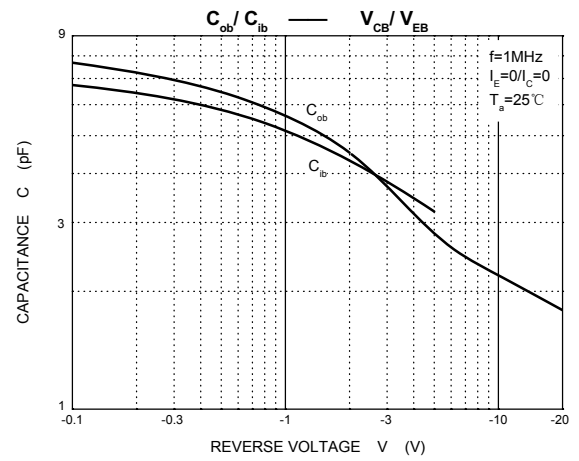
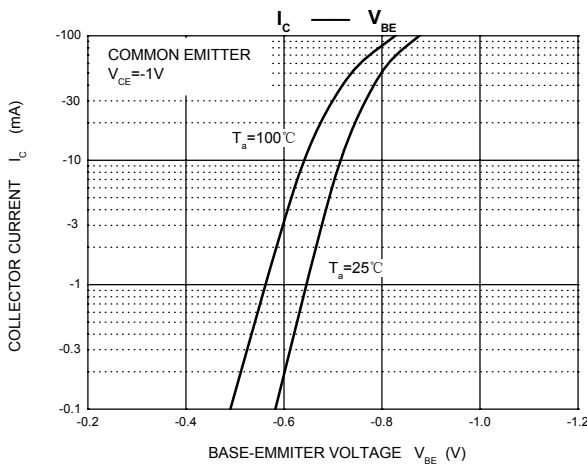
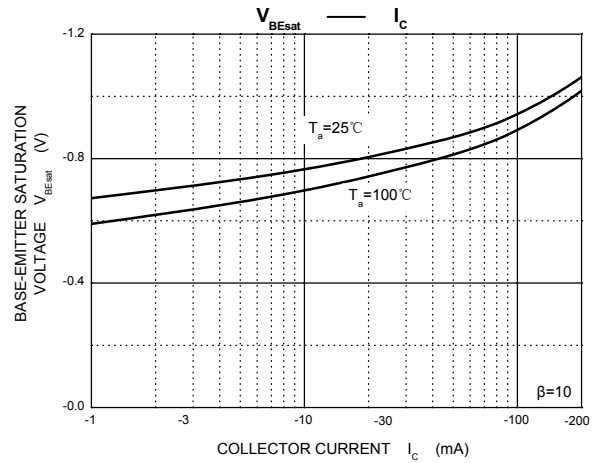
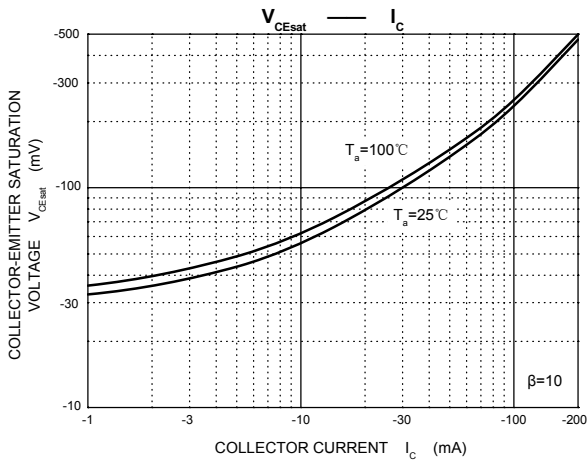
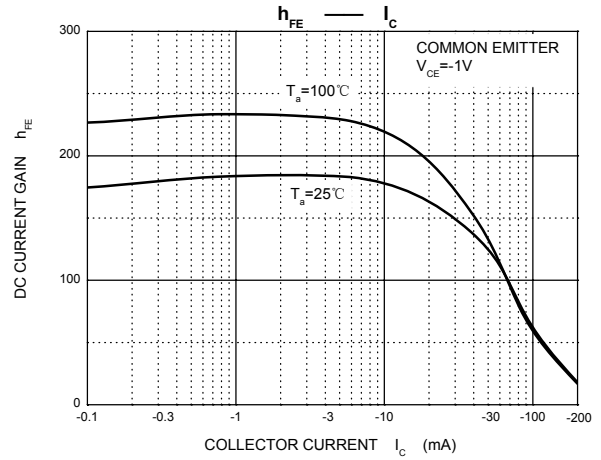
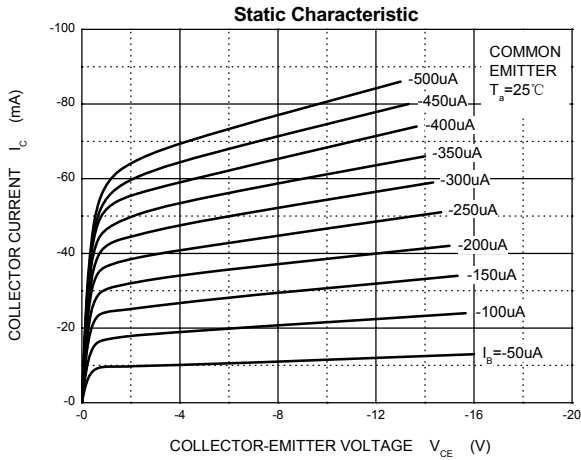

SOT-23 Package Outline Dimensions

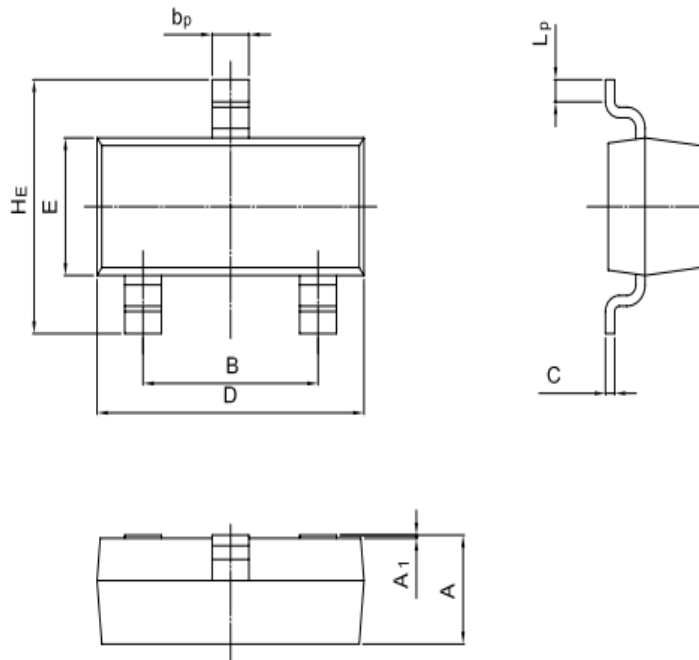

UNIT	A	B	bp	C	D	E	HE	A1	Lp
mm	1.40 0.95	2.04 1.78	0.50 0.35	0.19 0.08	3.10 2.70	1.65 1.20	3.00 2.20	0.100 0.013	0.50 0.20

SOT-23 Suggested Pad Layout

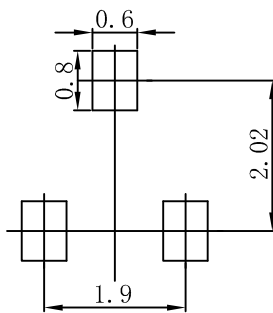

Note:

1. Controlling dimension: in millimeters.
2. General tolerance: ± 0.05 mm.
3. The pad layout is for reference purposes only.

NOTICE

JSJD reserve the right to make modifications, enhancements, improvements, corrections or other changes without further notice to any product herein. JSJD does not assume any liability arising out of the application or use of any product described herein.

Reel Taping Specifications For Surface Mount Devices-SOT-23

SOT-23 Embossed Carrier Tape

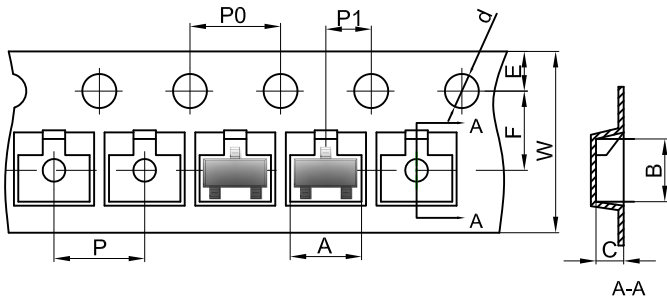

Packaging Description:

SOT-23 parts are shipped in tape. The carrier tape is made from a dissipative (carbon filled) polycarbonate resin. The cover tape is a multilayer film (Heat Activated Adhesive in nature) primarily composed of polyester film, adhesive layer, sealant, and anti-static sprayed agent. These reeled parts in standard option are shipped with 3,000 units per 7" or 17.8cm diameter reel. The reels are clear in color and is made of polystyrene plastic (anti-static coated).

Dimensions are in millimeter

Pkg type	A	B	C	d	E	F	P0	P	P1	W
SOT-23	3.15	2.77	1.22	Ø1.50	1.75	3.50	4.00	4.00	2.00	8.00

SOT-23 Tape Leader and Trailer

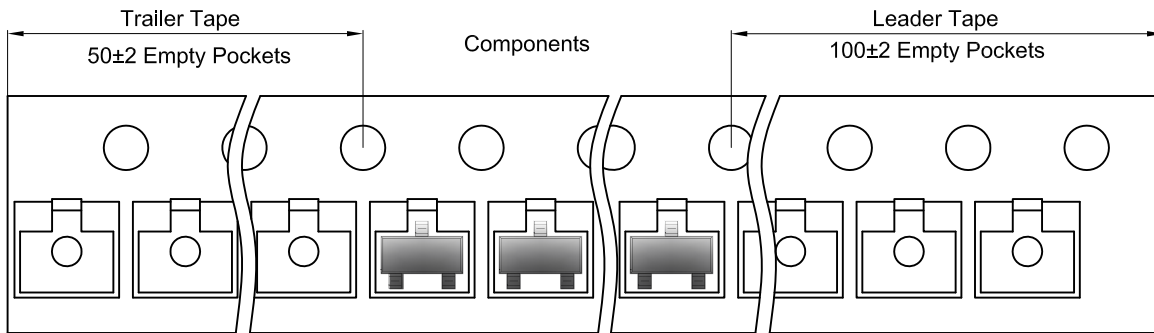

SOT-23 Reel

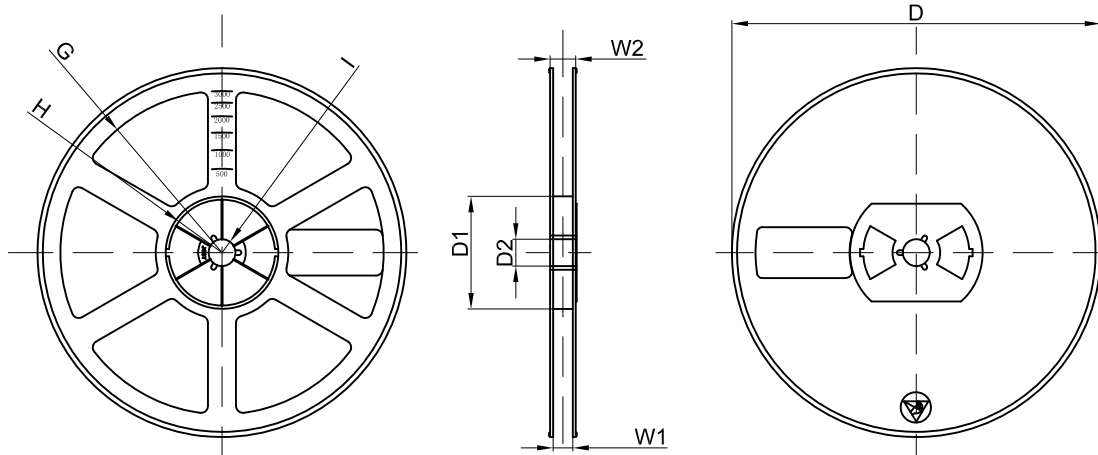

Dimensions are in millimeter

Reel Option	D	D1	D2	G	H	I	W1	W2
7" Dia	Ø178.00	54.40	13.00	R78.00	R25.60	R6.50	9.50	12.30

REEL	Reel Size	Box	Box Size(mm)	Carton	Carton Size(mm)	G.W.(kg)
3000 pcs	7 inch	45,000 pcs	203×203×195	180,000 pcs	438×438×230	