

DESCRIPTION

The HX2300A uses advanced trench technology to provide excellent $R_{DS(ON)}$, low gate charge and high density cell Design for ultra low on-resistance. This device is suitable for use as a load switch or in PWM applications.

GENERAL FEATURES

- ◇ $V_{DS} = 20V$, $I_D = 2.5A$
 $R_{DS(ON)}(Typ.) = 61m\Omega$ @ $V_{GS} = 2.5V$
 $R_{DS(ON)}(Typ.) = 46m\Omega$ @ $V_{GS} = 4.5V$
- ◇ High power and current handling capability
- ◇ Lead free product is acquired
- ◇ Surface mount package

APPLICATION

- ◇ PWM applications
- ◇ Load switch

PACKAGE

- ◇ SOT-23

SCHEMATIC DIAGRAM

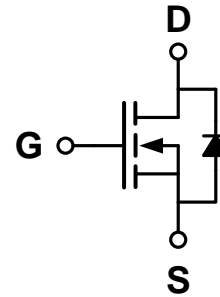

PIN ASSIGNMENT

SOT-23
(TOP VIEW)

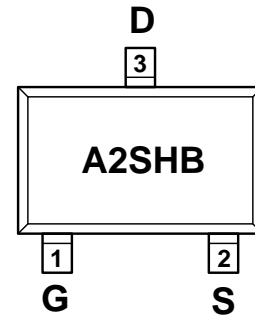

ORDERING INFORMATION

Part Number	Storage Temperature	Package	Marking	Devices Per Reel
HX2300A	-55°C to +150°C	SOT-23	A2SHB	3000

ABSOLUTE MAXIMUM RATINGS

($T_A = 25^\circ C$ unless otherwise noted)

parameter	symbol	limit	unit
Drain-source voltage	V_{DS}	20	V
Gate-source voltage	V_{GS}	± 12	V
Continuous drain current ($T_J = 150^\circ C$) ^a	$T_A = 25^\circ C$	2.5	A
	$T_A = 70^\circ C$	2.0	
Pulsed drain current ^b	I_{DM}	10	A
Continuous source current (diode conduction) ^a	I_S	0.6	
Power dissipation ^a	$T_A = 25^\circ C$	0.71	W
	$T_A = 70^\circ C$	0.46	
Operating junction and storage temperature range	T_J, T_{stg}	-55—150	°C

THERMAL CHARACTERISTICS

Parameter		Symbol	Typ	Max	Unit
Maximum junction-to-ambient ^a	≤ 5 s	R _{θJA}	120	145	°C/W
	Steady-State		140	175	
Maximum junction-to-foot	Steady-State	R _{θJC}	62	78	

Notes

- a. Surface mounted on 1" x 1" FR4 board
 b. Pulse width limited by maximum junction temperature

ELECTRICAL CHARACTERISTICS (T_A=25°C unless otherwise noted)

Parameter	Symbol	Condition	Min	Typ	Max	Unit
OFF Characteristics						
Drain-source breakdown voltage	BV _{DSS}	V _{GS} =0V, I _D =250μA	20	-	-	V
Zero gate voltage drain current	I _{DSS}	V _{DS} =20V, V _{GS} =0V	-	-	1	μA
Gate-body leakage	I _{GSS}	V _{DS} =0V, V _{GS} =±12V	-	-	±100	nA
ON Characteristics						
Gate threshold voltage	V _{GS(th)}	V _{DS} =V _{GS} , I _D =250μA	0.5	0.65	1.0	V
Drain-source on-state resistance ^a	R _{DS(ON)}	V _{GS} =4.5V, I _D =2.5A	-	46	60	mΩ
		V _{GS} =2.5V, I _D =1A	-	61	85	
Forward transconductance ^a	g _{fs}	V _{DS} =5V, I _D =2A	-	5	-	S
Dynamic Characteristics ^b						
Input capacitance	C _{ISS}	V _{DS} =10V, V _{GS} =0V f=1.0MHz	-	180	-	pF
Output capacitance	C _{OSS}		-	38	-	
Reverse transfer capacitance	C _{RSS}		-	20	-	
Switching Characteristics						
Turn-on delay time	t _{D(ON)}	V _{DD} =10V R _L =3 ohm V _{GEN} =4.5V R _{GEN} =6ohm	-	8	-	ns
Rise time	tr		-	7	-	
Turn-off delay time	t _{D(OFF)}		-	30	-	
Fall time	tf		-	7	-	
Total gate charge	Q _g	V _{DS} =10V I _D =2.5A V _{GS} =4.5V	-	3.5	-	nC
Gate-source charge	Q _{gs}		-	0.6	-	
Gate-drain charge	Q _{gd}		-	0.45	-	
DRAIN-SOURCE DIODE CHARACTERISTICS						
Diode forward voltage	V _{SD}	V _{GS} =0V, I _S =2.5A	-	0.76	1.16	V

Notes

- a. Pulse test: Pulse width ≤ 300 μs, duty cycle ≤ 2 %
 b. Guaranteed by design, not subject to production testing

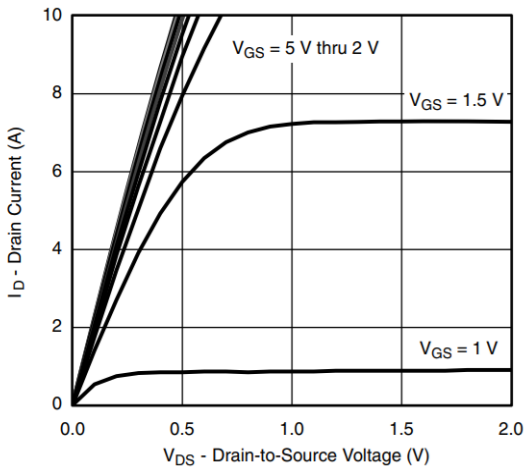
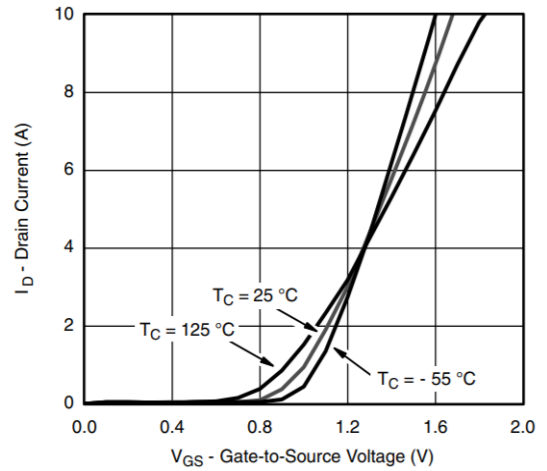
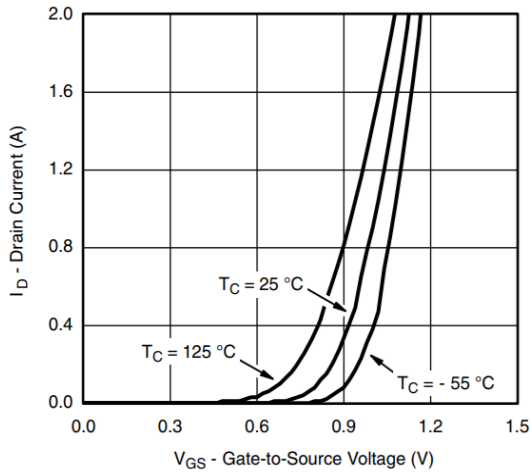
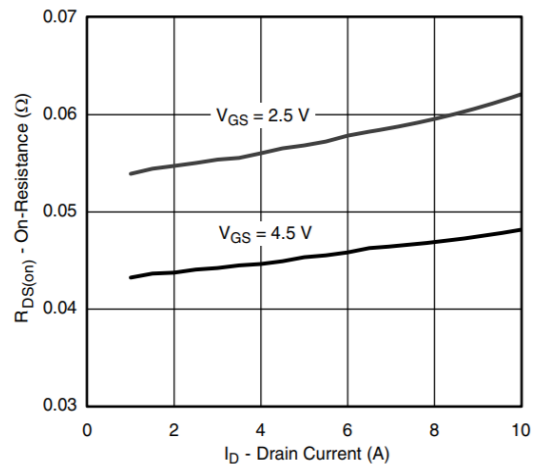
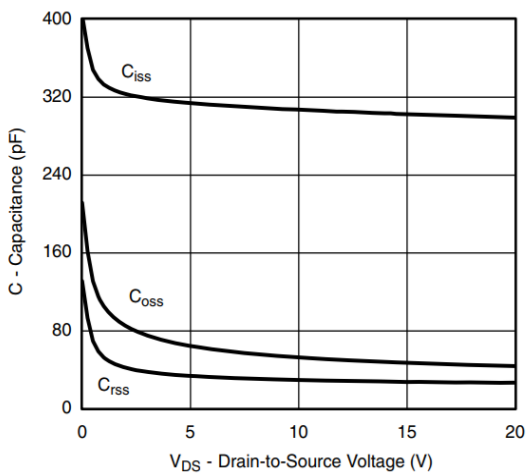
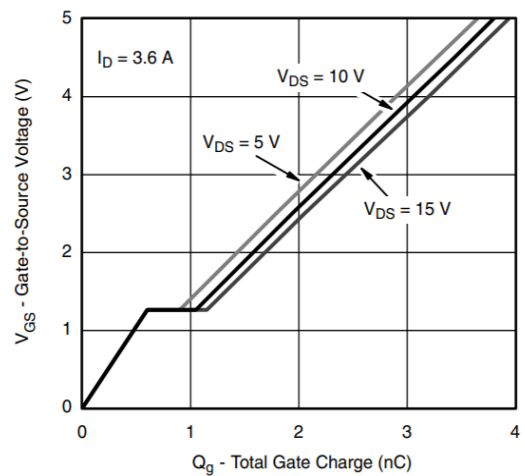
TYPICAL CHARACTERISTICS (25 °C, unless otherwise noted)

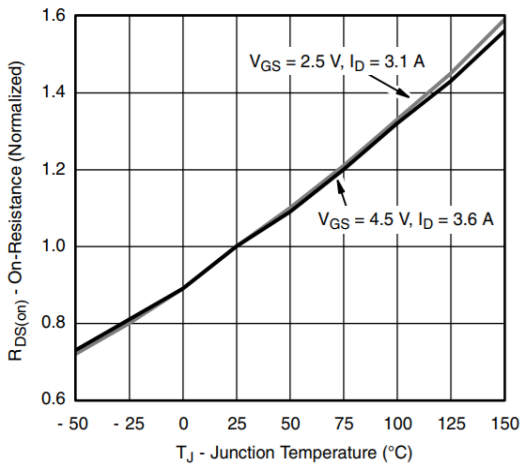
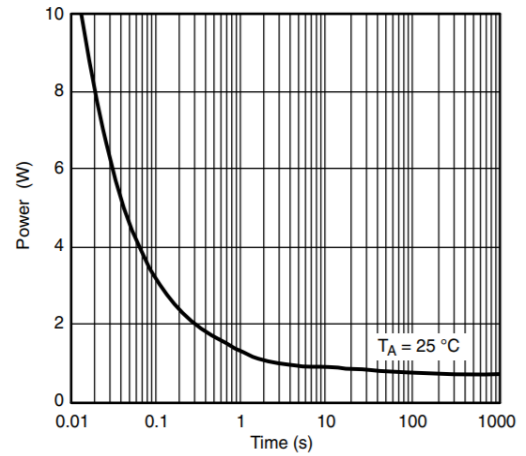
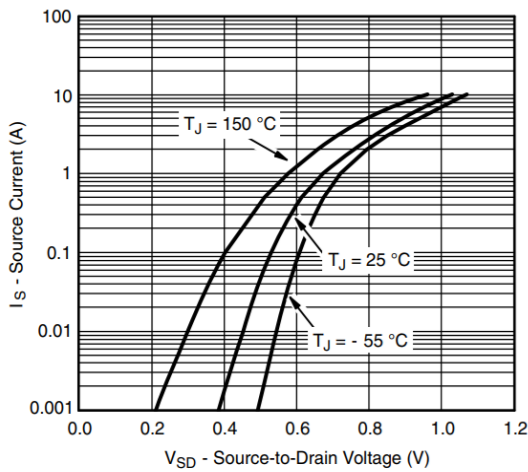
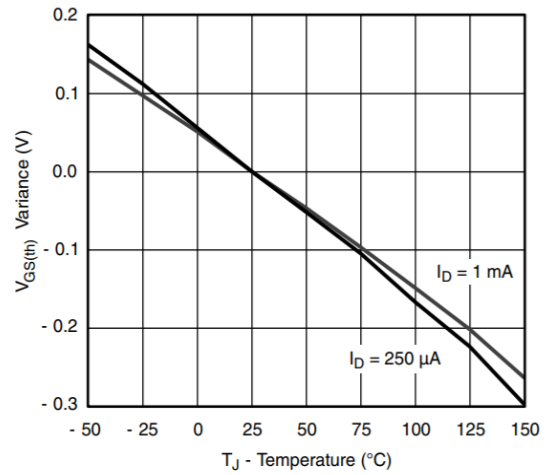
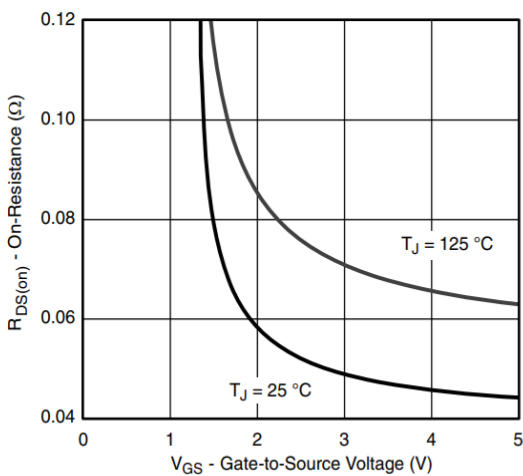
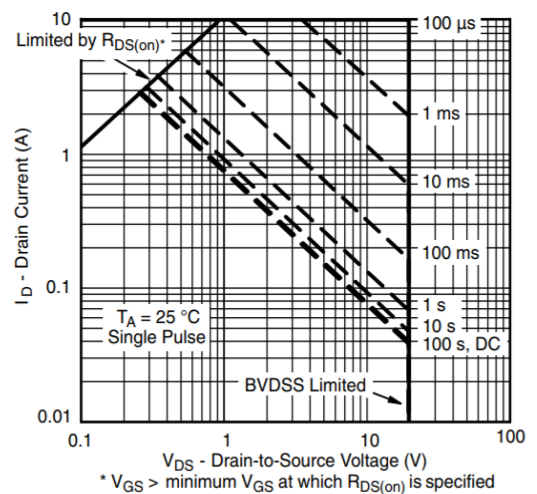
Output Characteristics

Transfer Characteristics

Transfer Characteristics

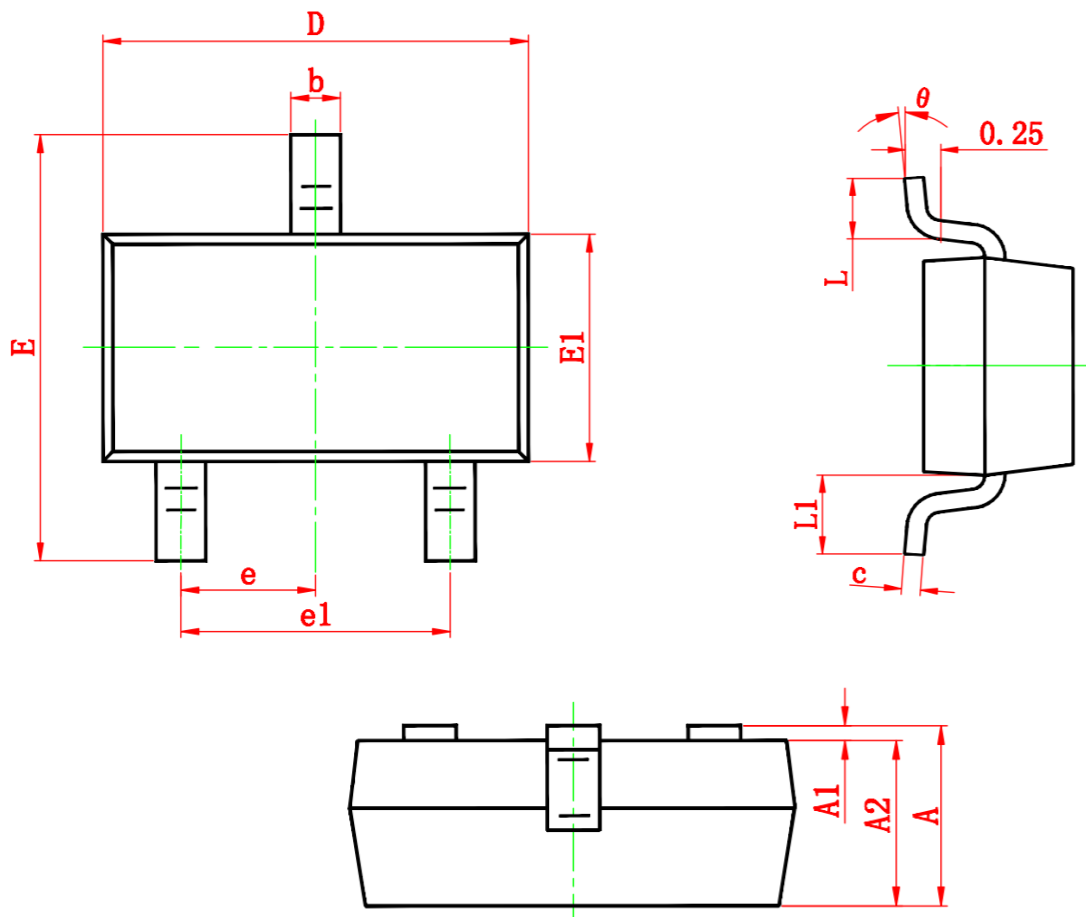
On-Resistance vs. Drain Current

Capacitance

Gate Charge

On-Resistance vs. Junction Temperature

Single Pulse Power

Source-Drain Diode Forward Voltage

Threshold Voltage

On-Resistance vs. Gate-to-Source Voltage

Safe Operating Area, Junction-to-Ambient

PACKAGE INFORMATION

- SOT-23



Symbol	Dimensions In Millimeters		Dimensions In Inches	
	Min.	Max.	Min.	Max.
A	0.900	1.150	0.035	0.045
A1	0.000	0.100	0.000	0.004
A2	0.900	1.050	0.035	0.041
b	0.300	0.500	0.012	0.020
c	0.080	0.150	0.003	0.006
D	2.800	3.000	0.110	0.118
E	2.250	2.550	0.089	0.100
E1	1.200	1.400	0.047	0.055
e	0.950 TYP.		0.037 TYP.	
e1	1.800	2.000	0.071	0.079
L	0.300	0.500	0.012	0.020
L1	0.550 REF.		0.022 REF.	
θ	0°	8°	0°	8°

RECOMMENDED MINIMUM PADS FOR SOT-23

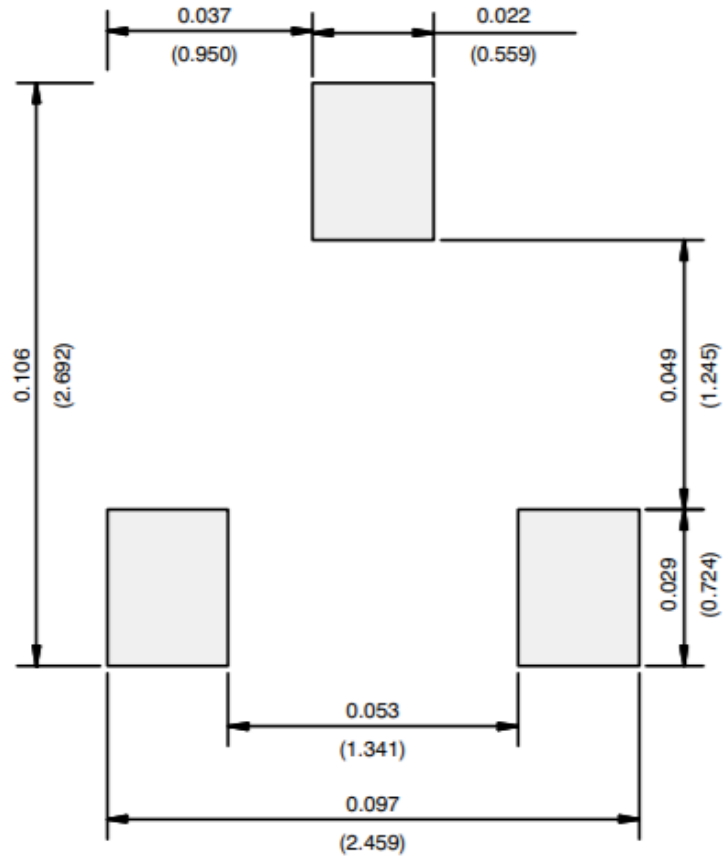

Recommended Minimum Pads
Dimensions in Inches/(mm)