

## Power Distribution Switch

### Features

- 49/70mΩ High-Side MOSFET
- Available with Current Limits with Foldback
- Operating Range: 2.7V to 5.5V
- 1mS Typical Rise Time
- Fast Overcurrent Response -1.5μs (TYPICAL)
- Under voltage Lockout
- Logic Level Enable Pin, Available with Active-High or Active-Low Version
- No Reverse Current when Power Off
- Deglitched Open-Drain Over-Current Flag Output (FLAG)
- Output Reverse-Voltage/Current Protection
- SOT-23-5, TSOT-23-6, TDFN2x2-6, WDFN2x2-6, TSOT-23-6 FC, TSOT-23-5 FC, and MSOP-8 Packages (Halogen Free/Pb Free)
- UL Certification #E232223
- CB Test Certification by IEC 60950-1:2005/ EN 60950-1:2006

### Applications

- High-Side Power Protection Switch
- USB Power Management
- USB Host and Self-Powered Bubs
- USB Bus-Powered Hubs
- Hot Plug-In Power Supplies
- Battery-Charger Circuits

### General Description

The G517 is an integrated power switch for self-powered and bus-powered Universal Serial Bus (USB) applications.

Several Protection features include current limiting and thermal shutdown to prevent catastrophic switch failure caused by increasing power dissipation when continuous heavy loads or short circuit occurs. A built-in charge pump is used to drive the N-channel MOSFET that is free of parasitic body diode to eliminate any reversed current flow across the switch when it is powered off. When the output voltage is higher than input voltage, the power switch is turned off by internal output reverse-voltage comparator.

FLAG is an open-drain output report over-current or over-temperature event and has typical 9ms deglitch timeout period.

### Pin Configuration

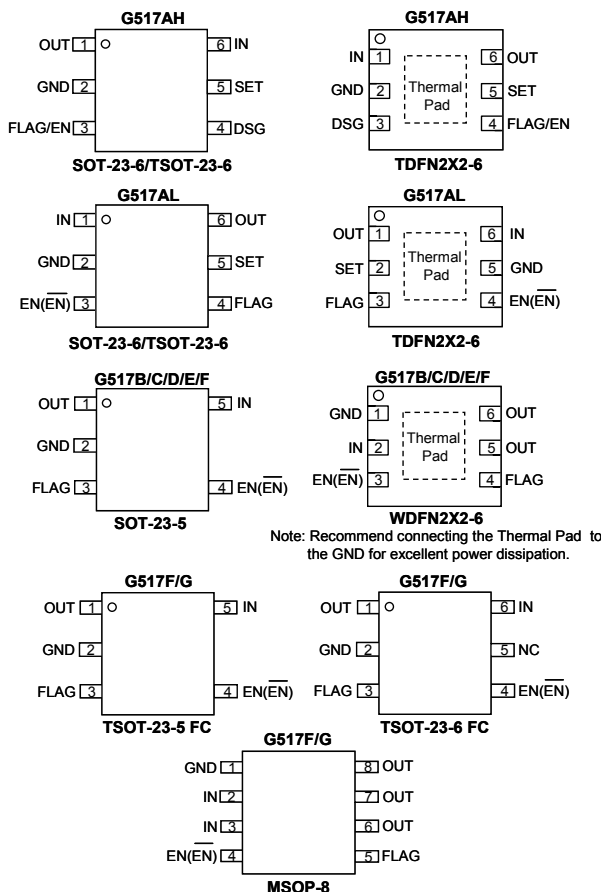

### Typical Application Circuit

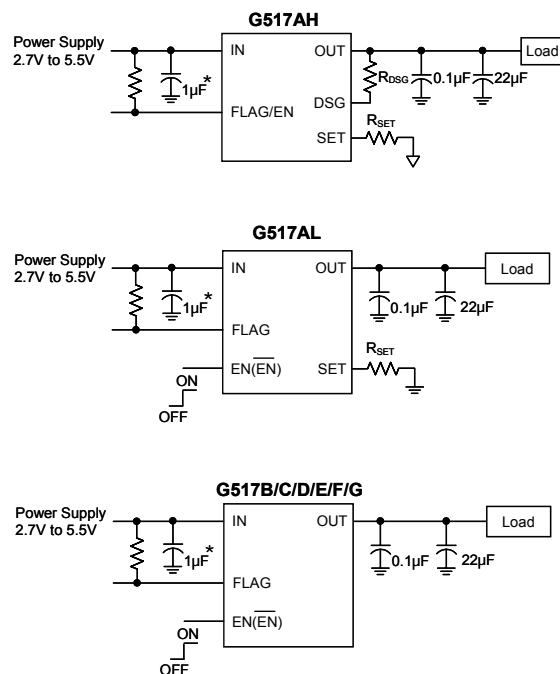

\*: 1μF of input capacitor is enough in most application cases.  
If the PCB trace of power rail to IN is long, larger input capacitor is necessary.

**Ordering Information**

ORDER NUMBER	MARKING	ENABLE	Current Limit	Output MOS $R_{DS(ON)}$	TEMP. RANGE	PACKAGE (Green)
G517AH1TP1U	5AACx	Active High	SET	70mΩ	-40°C to +85°C	TSOT-23-6
G517AH1TB1U	5AACx	Active High	SET	60mΩ	-40°C to +85°C	SOT-23-6
G517AH1RB1U	5AAC	Active High	SET	60mΩ	-40°C to +85°C	TDFN2x2-6
G517AL1TP1U	5AAAx	Active High	SET	70mΩ	-40°C to +85°C	TSOT-23-6
G517AL2TP1U	5AABx	Active Low	SET	70mΩ	-40°C to +85°C	TSOT-23-6
G517AL1TB1U	5AAAx	Active High	SET	60mΩ	-40°C to +85°C	SOT-23-6
G517AL2TB1U	5AABx	Active Low	SET	60mΩ	-40°C to +85°C	SOT-23-6
G517AL1RB1U	5AAA	Active High	SET	60mΩ	-40°C to +85°C	TDFN2x2-6
G517AL2RB1U	5AAB	Active Low	SET	60mΩ	-40°C to +85°C	TDFN2x2-6
G517AL1RB1D	5AAA	Active High	SET	60mΩ	-40°C to +85°C	TDFN2x2-6
G517AL2RB1D	5AAB	Active Low	SET	60mΩ	-40°C to +85°C	TDFN2x2-6
G517B1T11U	5AB1x	Active High	0.4A	75mΩ	-40°C to +85°C	SOT-23-5
G517B2T11U	5AB2x	Active Low	0.4A	75mΩ	-40°C to +85°C	SOT-23-5
G517B1U51U	5AB1	Active High	0.4A	70mΩ	-40°C to +85°C	WDFN2x2-6
G517B2U51U	5AB2	Active Low	0.4A	70mΩ	-40°C to +85°C	WDFN2x2-6
G517C1T11U	5AC1x	Active High	0.8A	75mΩ	-40°C to +85°C	SOT-23-5
G517C2T11U	5AC2x	Active Low	0.8A	75mΩ	-40°C to +85°C	SOT-23-5
G517C1U51U	5AC1	Active High	0.8A	70mΩ	-40°C to +85°C	WDFN2x2-6
G517C2U51U	5AC2	Active Low	0.8A	70mΩ	-40°C to +85°C	WDFN2x2-6
G517D1T11U	5AD1x	Active High	1.3A	75mΩ	-40°C to +85°C	SOT-23-5
G517D2T11U	5AD2x	Active Low	1.3A	75mΩ	-40°C to +85°C	SOT-23-5
G517D1U51U	5AD1	Active High	1.3A	70mΩ	-40°C to +85°C	WDFN2x2-6
G517D2U51U	5AD2	Active Low	1.3A	70mΩ	-40°C to +85°C	WDFN2x2-6
G517E1T11U	5AE1x	Active High	1.8A	75mΩ	-40°C to +85°C	SOT-23-5
G517E2T11U	5AE2x	Active Low	1.8A	75mΩ	-40°C to +85°C	SOT-23-5
G517E1U51U	5AE1	Active High	1.8A	70mΩ	-40°C to +85°C	WDFN2x2-6
G517E2U51U	5AE2	Active Low	1.8A	70mΩ	-40°C to +85°C	WDFN2x2-6
G517F1T11U	5AF1x	Active High	2.5A	65mΩ	-40°C to +85°C	SOT-23-5
G517F2T11U	5AF2x	Active Low	2.5A	65mΩ	-40°C to +85°C	SOT-23-5
G517F1U51U	5AF1	Active High	2.5A	64mΩ	-40°C to +85°C	WDFN2x2-6
G517F2U51U	5AF2	Active Low	2.5A	64mΩ	-40°C to +85°C	WDFN2x2-6
G517F1TP1U	5AF1x	Active High	2.5A	49mΩ	-40°C to +85°C	TSOT-23-6 FC
G517F2TP1U	5AF2x	Active Low	2.5A	49mΩ	-40°C to +85°C	TSOT-23-6 FC
G517F1TO1U	5AF1x	Active High	2.5A	49mΩ	-40°C to +85°C	TSOT-23-5 FC
G517F2TO1U	5AF2x	Active Low	2.5A	49mΩ	-40°C to +85°C	TSOT-23-5 FC
G517F1P81U	G517F1	Active High	2.5A	56mΩ	-40°C to +85°C	MSOP8
G517F2P81U	G517F2	Active Low	2.5A	56mΩ	-40°C to +85°C	MSOP8
G517G1TP1U	5AG1x	Active High	3.4A	49mΩ	-40°C to +85°C	TSOT-23-6 FC
G517G2TP1U	5AG2x	Active Low	3.4A	49mΩ	-40°C to +85°C	TSOT-23-6 FC
G517G1TO1U	5AG1x	Active High	3.4A	49mΩ	-40°C to +85°C	TSOT-23-5 FC
G517G2TO1U	5AG2x	Active Low	3.4A	49mΩ	-40°C to +85°C	TSOT-23-5 FC
G517G1P81U	G517G1	Active High	3.4A	56mΩ	-40°C to +85°C	MSOP8
G517G2P81U	G517G2	Active Low	3.4A	56mΩ	-40°C to +85°C	MSOP8

Note:T1:SOT-23-5 TB: SOT-23-6 TP:TSOT-23-6/TSOT-23-6 FC RB:TDFN2x2-6 U5:WDFN2x2-6 TO:TSOT-23-5 FC  
 P8: MSOP-8

1: Bonding Code

U&D: Tape & Reel

Green : Lead Free / Halogen Free.

## Absolute Maximum Ratings

Terminal Voltage (with respect to GND)	
IN Pin Voltage, $V_{IN}$	-0.3V to +6.0V
OUT Pin Voltage, $V_{OUT}$	-0.3V to +6.0V
EN Pin Voltage, $V_{EN}$	-0.3V to +6.0V
SET Pin Voltage, $V_{SET}$	-0.3V to $V_{IN}+0.3V$
FLAG Pin Voltage, $V_{FLAG}$	-0.3V to +6.0V
DSG Pin Voltage, $V_{DSG}$	-0.3V to +6.0V
Junction Temperature	150°C
Storage Temperature ( $T_S$ )	-65°C to +150°C
Reflow Temperature (soldering, 10sec)	260°C
ESD (HBM) <sup>(1)</sup>	2kV
Output ESD Protection	4kV

Continuous Power Dissipation ( $T_A=+25^\circ\text{C}$ )*	
SOT-23-5	0.52W
TSOT-23-6	0.52W
TDFN2X2-6/WDFN2X2-6	0.55W
MSOP-8	0.57W
TSOT-23-5/6 FC	TBDW
Thermal Resistance Junction to Ambient, ( $\theta_{JA}$ )*	
SOT-23-5	240°C/W
TSOT-23-6	240°C/W
TDFN2X2-6/WDFN2X2-6	255°C/W
MSOP-8	200°C/W
TSOT-23-5/6 FC	TBD°C/W
Thermal Resistance Junction to Case, ( $\theta_{JC}$ )	
SOT-23-5	60°C/W
TSOT-23-6	60°C/W
TDFN2X2-6/WDFN2X2-6	63°C/W
MSOP-8	55°C/W
TSOT-23-5/6 FC	TBD°C/W

## Operating Ratings

Supply Voltage ( $V_{IN}$ )	3V to 5.5V
Operating Temperature ( $T_A$ )	-40°C to +85°C

\*Please refer to Minimum Footprint PCB Layout Section.

(1) Human body model is a 100pF capacitor discharged through a 1.5kΩ resistor into each pin.

## Electrical Characteristics (G517AH)

$V_{IN} = 5V$ ,  $C_{IN} = 1\mu F$ ,  $C_{OUT} = 1\mu F$ ,  $R_L = 10\Omega$ ,  $T_A = 25^\circ\text{C}$ .

The device is not guaranteed to function outside its operating conditions. Parameters with MIN and/or MAX limits are 100% tested at +25°C, unless otherwise specified.

DESCRIPTION	SYMBOL	CONDITION	MIN	TYP	MAX	UNIT	
Operation Voltage	$V_{IN}$		2.7	---	5.5	V	
Quiescent Current	$I_Q$	$V_{IN}=5V$ , $I_{OUT}=0$ , not including $I_{RSET}$	---	150	200	μA	
Off Supply Current	$I_{Q(OFF)}$	$V_{IN}=5V$ , FLAG/EN=0	---	20	40	μA	
$V_{IN}$ Under-Voltage Lockout	$V_{UVLO}$		2.0	---	2.6	V	
Output MOS $R_{DS(ON)}$	$R_{DS(ON)}$	$I_{OUT}=1.5A$ , $R_{SET}=10.5k\Omega$	TSOT-23-6	---	70	90	mΩ
			SOT-23-6	---	60	75	
			TDFN2x2-6	---	60	75	
Over Current Trigger Point	$I_{LIM}$	$R_{SET}=7.68k\Omega$	2.43	2.7	2.97	A	
		$R_{SET}=10.5k\Omega$	1.8	2	2.2		
		$R_{SET}=21k\Omega$	0.9	1	1.1		
		$R_{SET}=42k\Omega$	0.4	0.5	0.6		
EN Input Threshold-High $V_{IH}$	$V_{EN(H)}$	$V_{IN}=2.7V$ to 5.5V	1.2	---	---	V	
EN Input Threshold-Low $V_{IL}$	$V_{EN(L)}$	$V_{IN}=2.7V$ to 5.5V	---	---	0.6	V	
Output Turn-on Rising Time	$T_r$	$R_{LOAD}=100\Omega$ , $C_{OUT}=1\mu F$ , 90% Settling	$V_{IN}=5V$	1.0	1.5	2	ms
			$V_{IN}=3.3V$	1.6	2	2.4	
FLAG Deglitch	$T_{FLAG}$	Over Current Condition	2	3	4	ms	
	$T_{SCS}$	Short Circuit Start	3	5	7	ms	
Shutdown DSG Pull Low Resistance			---	15	30	Ω	
$t_{IOS}$ Response Time to Short Circuit	$t_{IOS}$	$V_{IN}=5V$ , see figure 1, 2	---	1.5	---	μs	
Output Reverse-Voltage Trigger Point ( $V_{OUT}-V_{IN}$ )		$V_{IN}=5V$	30	60	---	mV	
Output Reverse-Voltage Deglitch Time		$V_{IN}=5V$	---	0.7	---	ms	
Thermal Shutdown	OT	Rising temperature	---	150	225	°C	
	OT <sub>HYS</sub>	Hysteresis	---	50	---		

**Electrical Characteristics (G517AL)**
 $V_{IN} = 5V, C_{IN} = 1\mu F, C_{OUT} = 1\mu F, R_L = 10\Omega, T_A = 25^\circ C.$ 

The device is not guaranteed to function outside its operating conditions. Parameters with MIN and/or MAX limits are 100% tested at +25°C, unless otherwise specified.

DESCRIPTION	SYMBOL	CONDITION	MIN	TYP	MAX	UNIT	
Operation Voltage	$V_{IN}$		2.7	---	5.5	V	
Quiescent Current	$I_Q$	$V_{IN} = 5V, I_{OUT} = 0,$ $EN(\overline{EN}) = \text{Active}$	$R_{SET} = 20k\Omega$	---	150	---	$\mu A$
			$R_{SET} = 100k\Omega$	---	135	---	
Off Supply Current	$I_{Q(OFF)}$	$V_{IN} = 5.5V, EN(\overline{EN}) = \text{Inactive}$	---	---	1	$\mu A$	
$V_{IN}$ Under-Voltage Lockout	$V_{UVLO}$		1.7	2.1	2.4	V	
Output MOS $R_{DS(ON)}$	$R_{DS(ON)}$	$I_{OUT} = 2A, R_{SET} = 10k\Omega$	TSOT-23-6	---	70	90	m $\Omega$
			SOT-23-6	---	60	75	
			TDFN2x2-6	---	60	75	
$R_{SET}$ Resistor Range		$V_{IN} = 3V$	20	---	200	k $\Omega$	
		$V_{IN} = 5V$	10	---	200		
Over Current Trigger Point	$I_{LIM}$	$R_{SET} = 11k\Omega$	2.25	2.5	2.75	A	
		$R_{SET} = 24.9k\Omega$	0.9	1	1.1		
		$R_{SET} = 37.4k\Omega$	0.6	0.7	0.8		
		$R_{SET} = 49.9k\Omega$	0.425	0.5	0.575		
		$R_{SET} = 75k\Omega$	0.264	0.33	0.4		
Short-Circuit Fold-Back Current	$I_{SFB}$	$R_{SET} = 11k\Omega, V_{IN} > 3.5V$ and $V_{OUT} < 1V$	---	1.67	---	A	
		$R_{SET} = 24.9k\Omega, V_{IN} > 3.5V$ and $V_{OUT} < 1V$	---	0.67	---		
		$R_{SET} = 37.4k\Omega, V_{IN} > 3.5V$ and $V_{OUT} < 1V$	---	0.47	---		
		$R_{SET} = 49.9k\Omega, V_{IN} > 3.5V$ and $V_{OUT} < 1V$	---	0.33	---		
		$R_{SET} = 75k\Omega, V_{IN} > 3.5V$ and $V_{OUT} < 1V$	---	0.22	---		
		$R_{SET} = 100k\Omega, V_{IN} > 3.5V$ and $V_{OUT} < 1V$	---	0.17	---		
EN Input Threshold-High $V_{IH}$	$V_{EN(H)}$	$V_{IN} = 2.7V$ to 5.5V	1.2	---	---	V	
EN Input Threshold-Low $V_{IL}$	$V_{EN(L)}$	$V_{IN} = 2.7V$ to 5.5V	---	---	0.6	V	
Output Turn-on Rising Time	$T_r$	$R_{LOAD} = 100\Omega, C_{OUT} = 1\mu F,$ 90% Settling	$V_{IN} = 5V$	1.0	1.5	2	ms
			$V_{IN} = 3.3V$	1.6	2	2.4	
FLAG Deglitch	$T_{FLAG}$	FLAG assertion or deassertion	5	9	15	ms	
Shutdown OUT Pull Low Resistance			---	600	900	$\Omega$	
$t_{IOS}$ Response Time to Short Circuit	$t_{IOS}$	$V_{IN} = 5V$ , see figure 1, 2	---	1.5	---	$\mu s$	
Output Reverse-Current threshold			0.5	---	---	A	
Output Reverse-Current Deglitch Time		$V_{IN} = 5V$	---	5	---	ms	
Over Current Regulation Time	$T_{REG}$	$V_{IN} = 5V$	6	9	12	ms	
Over Current Protection Time	$T_{OCP}$	$V_{IN} = 5V$	54	64	74	ms	
Thermal Shutdown	OT	Rising temperature	---	150	---	$^\circ C$	
	OT <sub>HYS</sub>	Hysteresis	---	20	---		

## Electrical Characteristics (G517B/C/D/E/F/G)

$V_{IN} = 5V$ ,  $C_{IN} = 1\mu F$ ,  $C_{OUT} = 1\mu F$ ,  $R_L = 10\Omega$ ,  $T_A = 25^\circ C$ .

The device is not guaranteed to function outside its operating conditions. Parameters with MIN and/or MAX limits are 100% tested at  $+25^\circ C$ , unless otherwise specified.

PARAMETER	SYMBOL	CONDITION	MIN	TYP	MAX	UNIT	
Input Voltage Range	$V_{IN}$		2.7	---	5.5	V	
Quiescent Current	$I_Q$		---	130	190	$\mu A$	
Off Supply Current	$I_{Q(OFF)}$	$V_{IN} = 5.5V$ , $EN(\overline{EN}) = \text{Inactive}$	---	0.1	1	$\mu A$	
$V_{IN}$ Under Voltage Lockout	$V_{UVLO}$		2.2	2.4	2.6	V	
Output MOS $R_{DS(ON)}$	$R_{DS(ON)}$	G517B, $I_{OUT} = 0.1A$ G517C, $I_{OUT} = 0.3A$ G517D, $I_{OUT} = 0.8A$ G517E, $I_{OUT} = 1.3A$	SOT-23-5	---	78	95	m $\Omega$
			WDFN2x2-6	---	70	85	
		G517F, $I_{OUT} = 2.0A$ G517G, $I_{OUT} = 2.9A$	SOT-23-5	---	66	75	
			WDFN2x2-6	---	64	76	
			MSOP-8	---	56	68	
			TSOT-23-5/6 FC	---	49	59	
Over Current Trigger Point	$I_{LIM}$	G517B		0.3	0.4	0.5	A
		G517C		0.6	0.8	1.0	
		G517D		1.1	1.3	1.5	
		G517E		1.6	1.8	2.0	
		G517F		2.2	2.5	2.8	
		G517G		3.1	3.4	4.0	
Short-Circuit Fold-Back Current	$I_{SFB}$	G517B, $V_{IN} > 3.5V$ and $V_{OUT} < 1V$		--	0.3	--	A
		G517C, $V_{IN} > 3.5V$ and $V_{OUT} < 1V$		--	0.5	--	
		G517D, $V_{IN} > 3.5V$ and $V_{OUT} < 1V$		--	0.8	--	
		G517E, $V_{IN} > 3.5V$ and $V_{OUT} < 1V$		--	1.2	--	
		G517F, $V_{IN} > 3.5V$ and $V_{OUT} < 1V$		--	1.7	--	
		G517G, $V_{IN} > 3.5V$ and $V_{OUT} < 1V$		--	2.3	--	
EN Input Threshold-High $V_{IH}$	$V_{EN(H)}$		1.2	---	---	V	
EN Input Threshold-Low $V_{IL}$	$V_{EN(L)}$		---	---	0.6	V	
Output Turn-on Rising Time	$T_r$	$R_{LOAD} = 10\Omega$ , $C_{OUT} = 10\mu F$ , 90% Settling	$V_{IN} = 5V$	1	1.5	2	ms
			$V_{IN} = 3.3V$	1.8	2.4	3	
FLAG Deglitch	$T_{FLAG}$	FLAG assertion or deassertion	4	9	15	ms	
Shutdown OUT Pull Low Resistance			---	150	225	$\Omega$	
$t_{IOS}$ Response Time to Short Circuit	$t_{IOS}$	$V_{IN} = 5V$ , see figure 1,2	---	1.5	---	$\mu s$	
Output Leakage Current		$EN = "0"$ , $V_{OUT} = 5V$	---	0.5	1	$\mu A$	
Output Reverse-Current threshold		G517B/C/D/E	0.4	---	--	A	
		G517F/G	0.55	---	--		
Output Reverse-Current Deglitch Time	$T_{OCP}$	$V_{IN} = 5V$	---	5	---	ms	
Thermal Limit	OT		---	140	---	$^\circ C$	
Thermal Limit Hysteresis	$OT_{HYS}$		---	20	---	$^\circ C$	

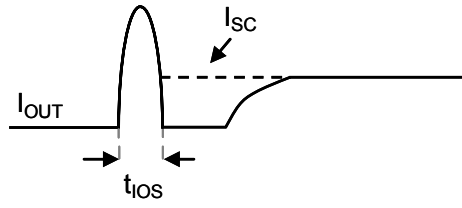

Figure 1

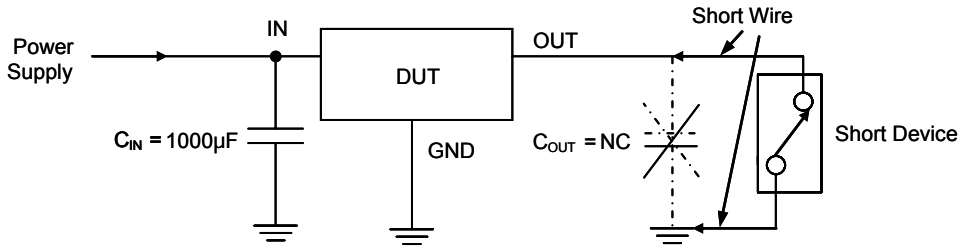

Figure 2

**Note:**

To exactly identify the short circuit characteristic of IC, avoid the test result interfered by parasitic inductor, output capacitor, and contact resistor. It is necessary to follow the recommendation as follows.

Please,

1. Add 1000µF of capacitor between  $V_{IN}$  and GND, and close to IC.
2. Remove output capacitor.
3. Shorter the short circuit device wire.
4. Measure output current ( $I_{OUT}$ ).

**Minimum Footprint PCB Layout Section**

**SOT-23-5/TSOT-23-5**

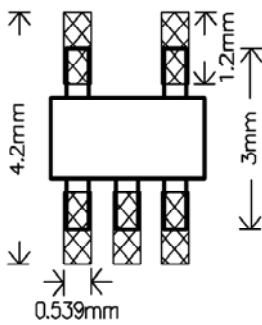

**SOT-23-6/TSOT-23-6**

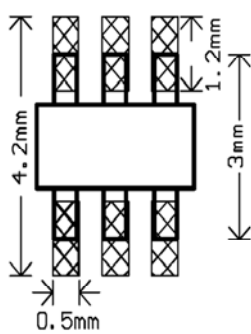

**TDFN2X2-6/WDFN2X2-6**

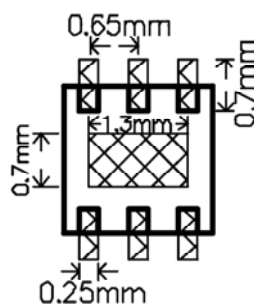

**MSOP-8**

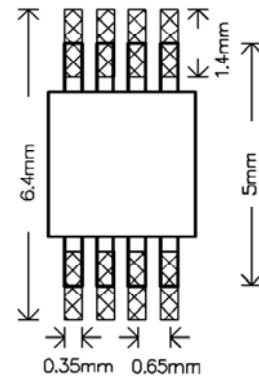

## Typical Performance Characteristics

G517AH,  $V_{IN}=5V$ ,  $C_{IN}=1\mu F$ ,  $C_{OUT}=1\mu F$ ,  $T_A=25^\circ C$ , unless otherwise noted.

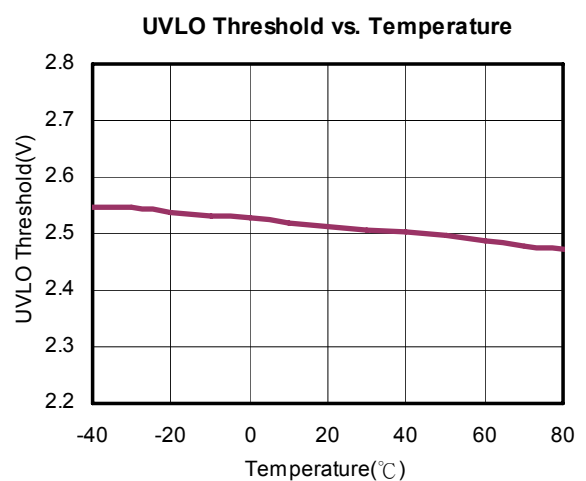
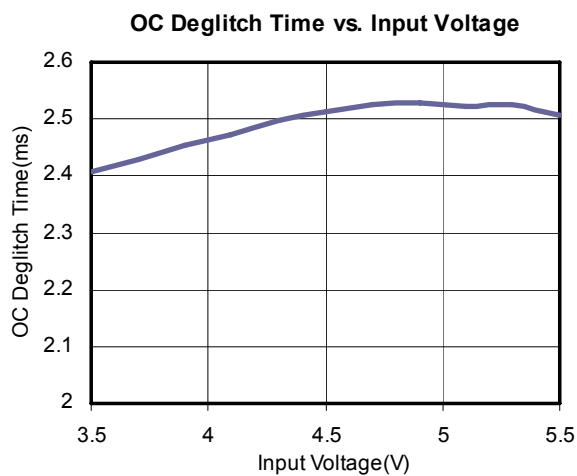
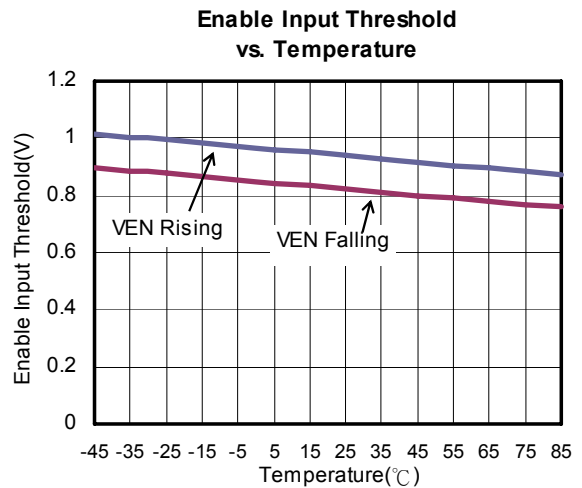
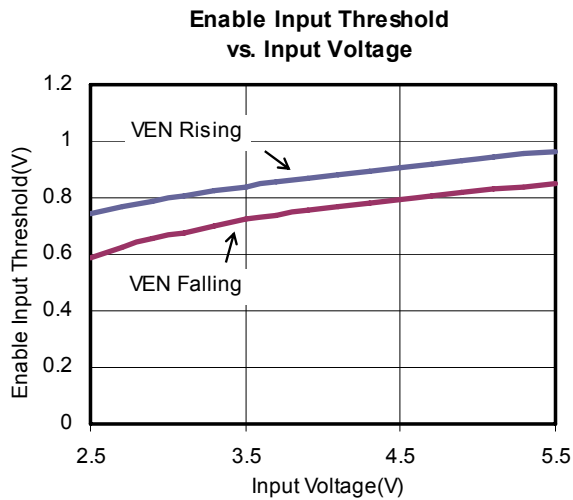
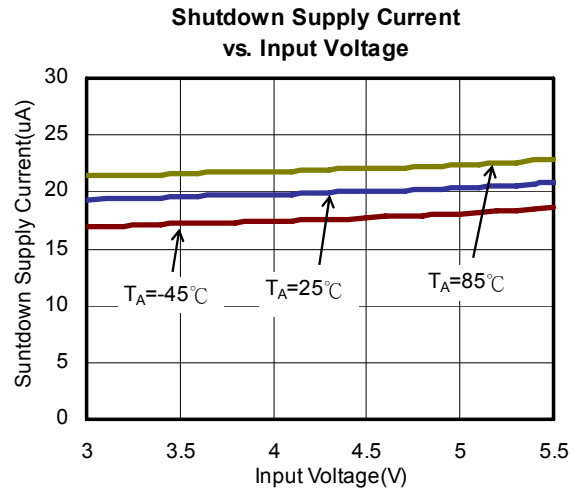
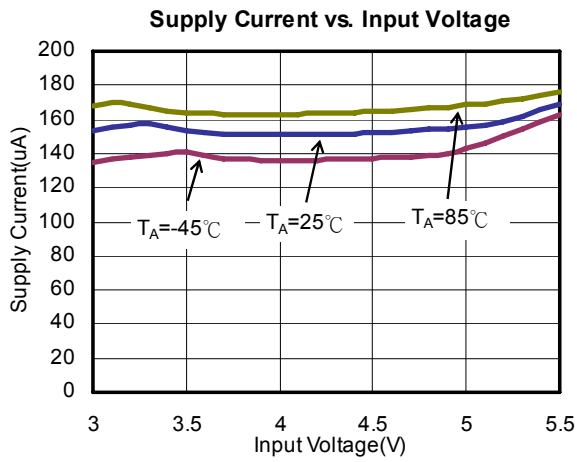

**Typical Performance Characteristics (Continued)**

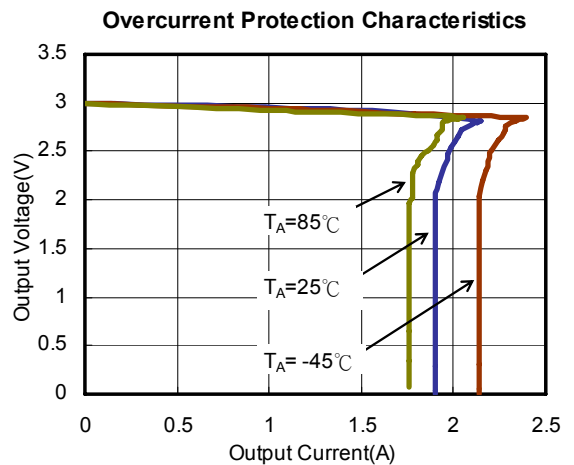
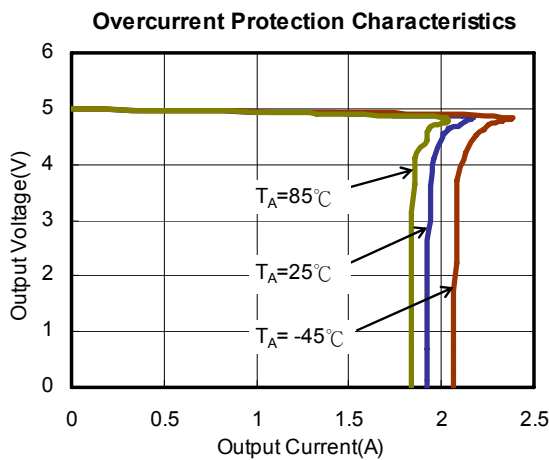
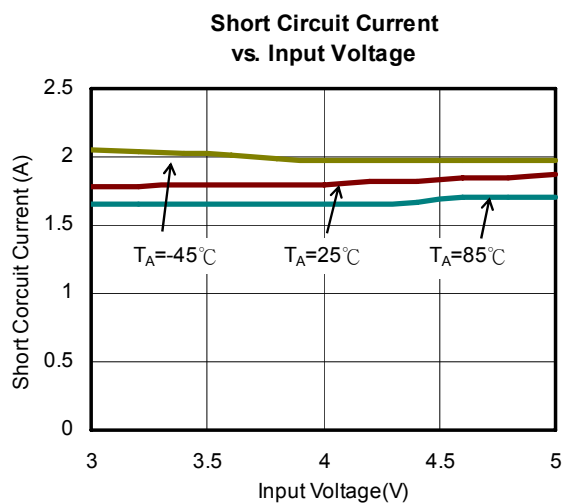
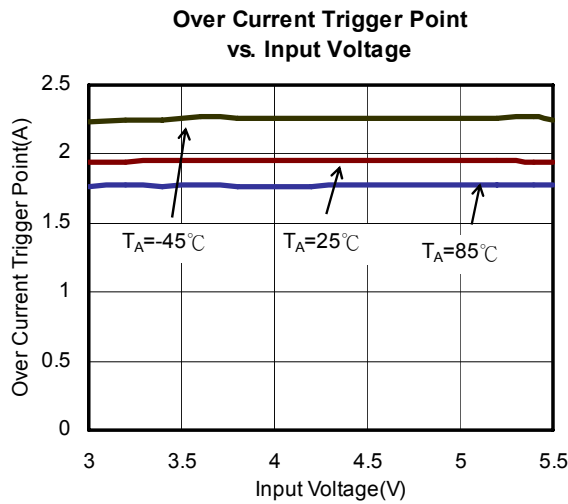
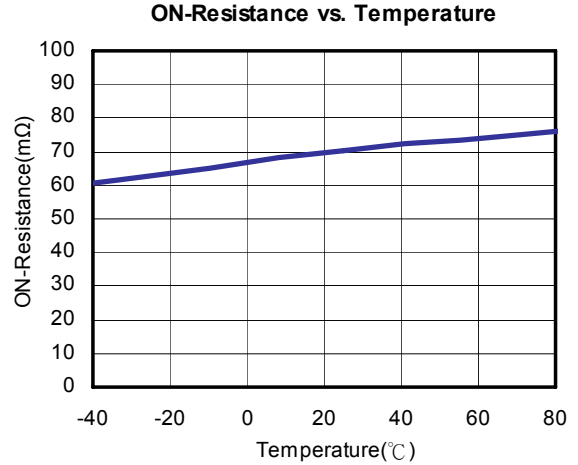
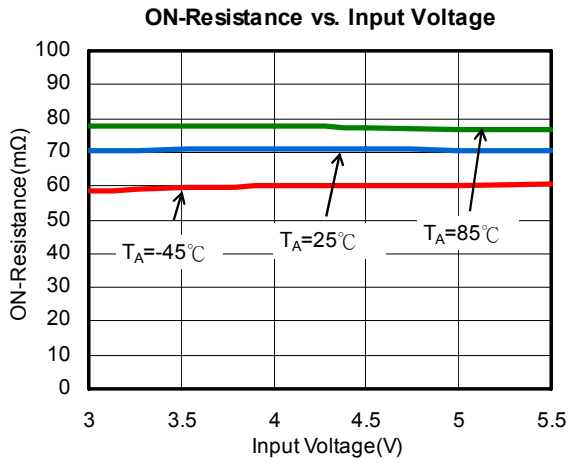



Typical Performance Characteristics (Continued)

Output Reverse Current vs. Input Voltage

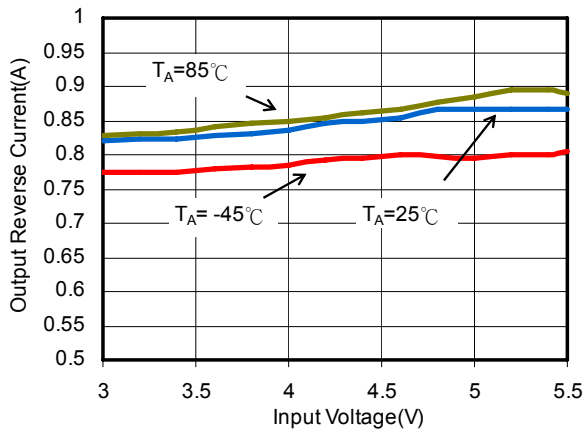

Output Reverse Current vs. Temperature

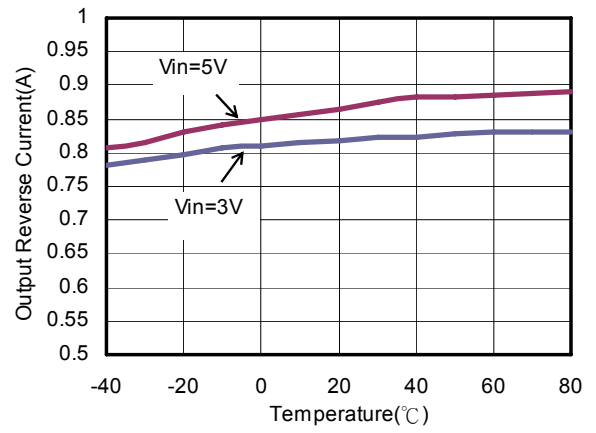

Over Current Trigger Point vs. Temperature

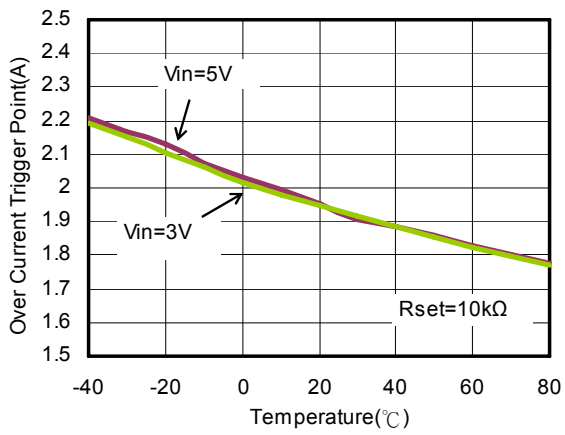

Typical Performance Characteristics (Continued)

Turn on Delay Time and Rise Time

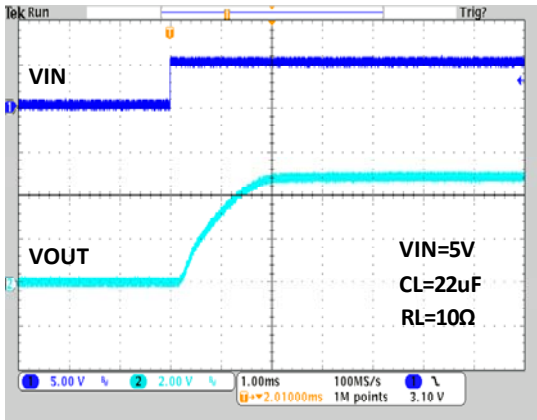

Turn off Delay Time and Fall Time

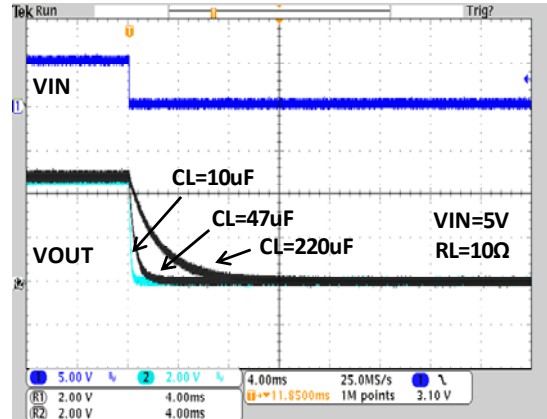

Inrush Current with Load Capacitance

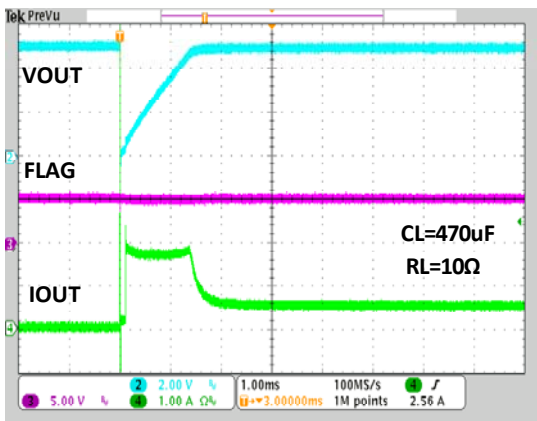

Over Current Protection

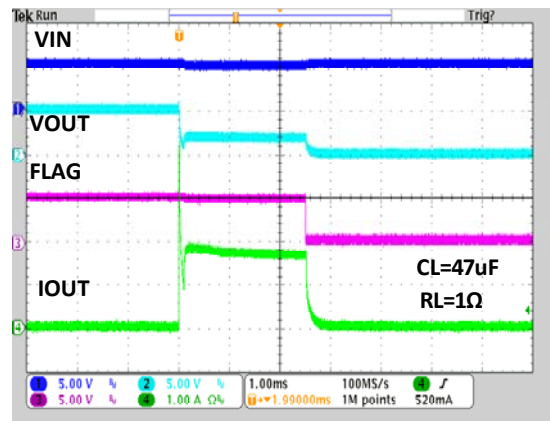

UVLO Protection at Rising

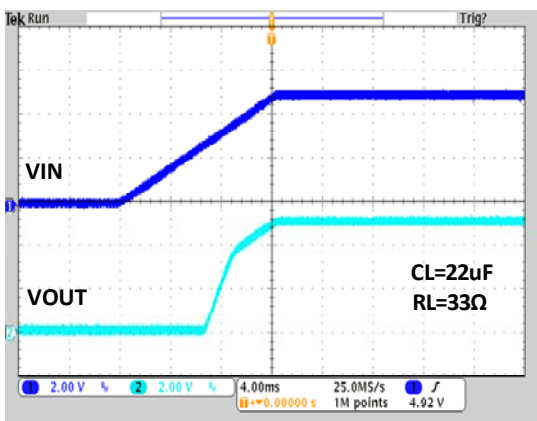

UVLO Protection at Falling

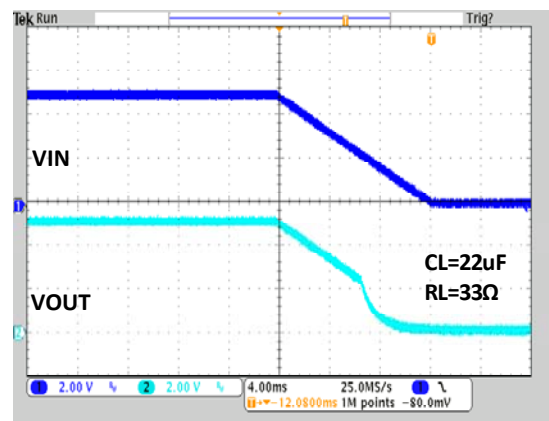

Typical Performance Characteristics (Continued)

Inrush Short Circuit Response

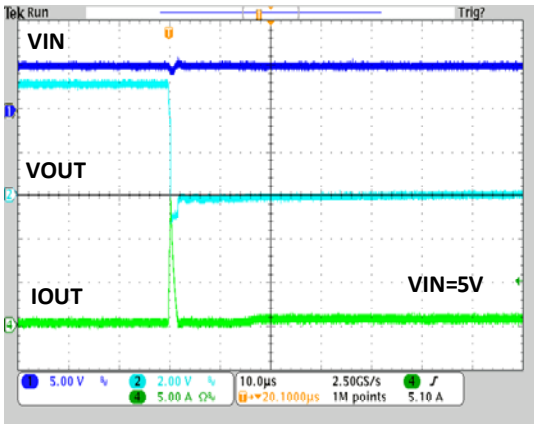

Resistance Load Inrush Response

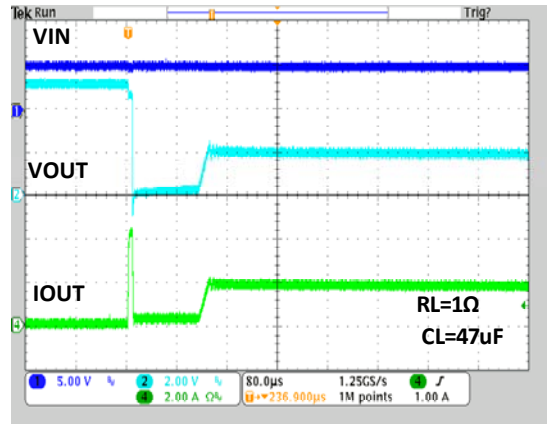

Short-Circuit Current, Device Enable into Short

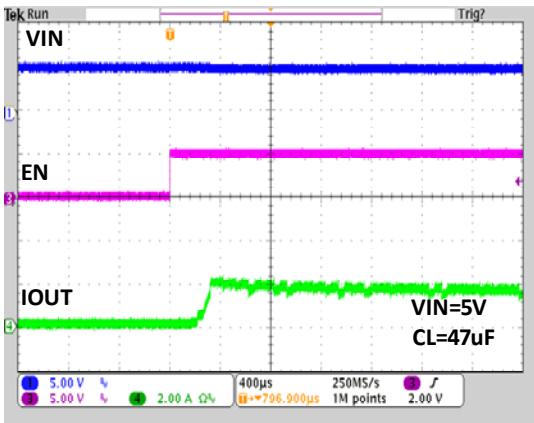

Short Circuit Response at Start up

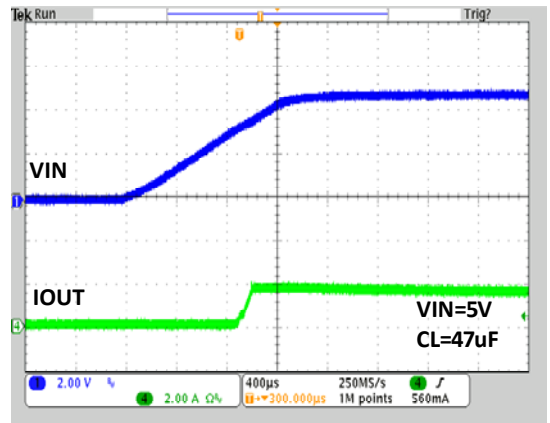

Capacitance Load Inrush Response

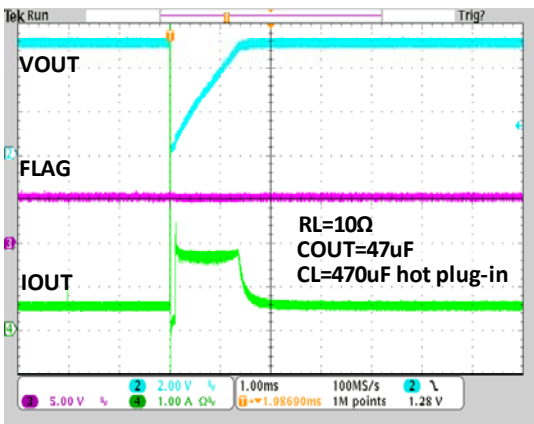

Capacitance Load Inrush Response

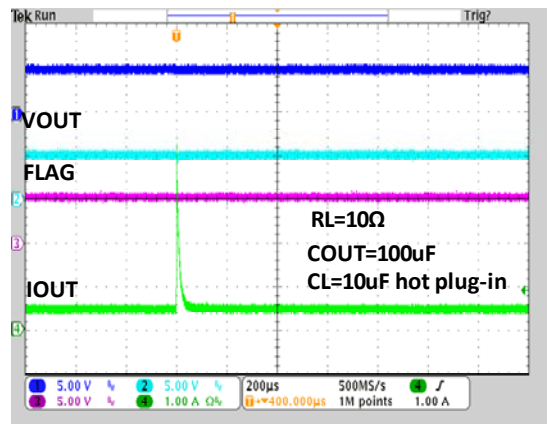

Typical Performance Characteristics (Continued)

Reverse-Voltage Protection Response

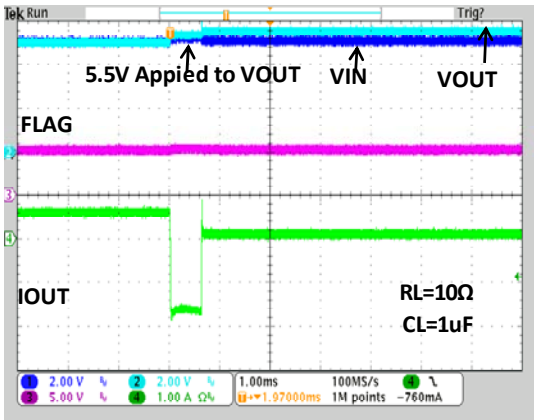

Reverse-Voltage Protection Recovery

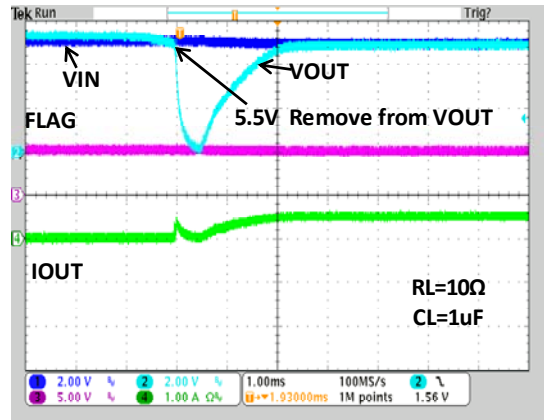

**Typical Performance Characteristics**

G517AL,  $V_{IN}=5V$ ,  $C_{IN}=1\mu F$ ,  $C_{OUT}=1\mu F$ ,  $T_A=25^\circ C$ , unless otherwise noted.)

**Supply Current vs. Input Voltage**

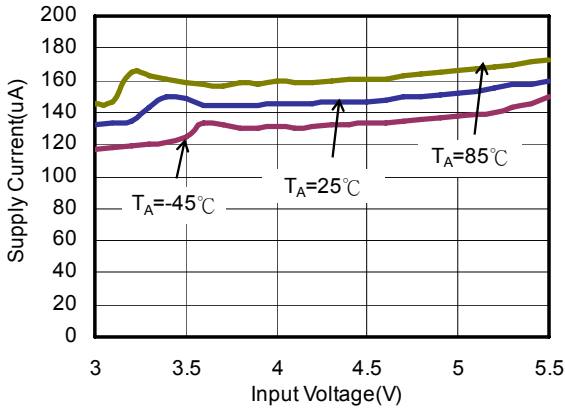

**Shutdown Supply Current vs. Input Voltage**

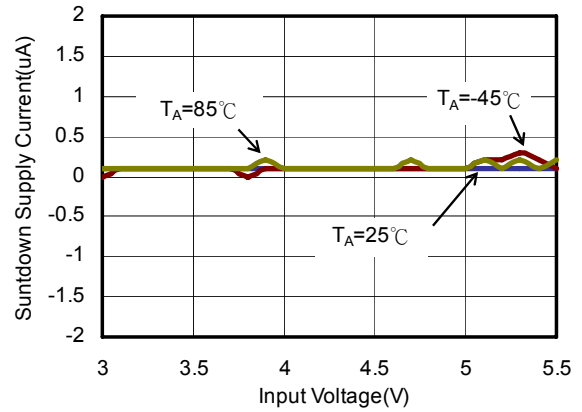

**Enable Input Threshold vs. Input Voltage**

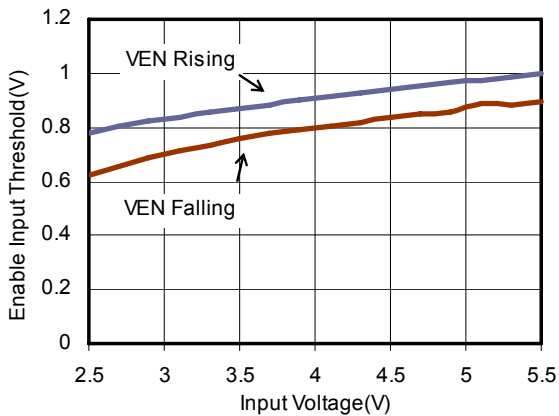

**Enable Input Threshold vs. Temperature**

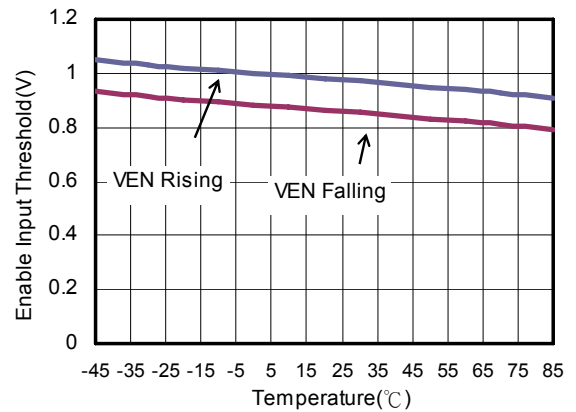

**OC Deglitch Time vs. Input Voltage**

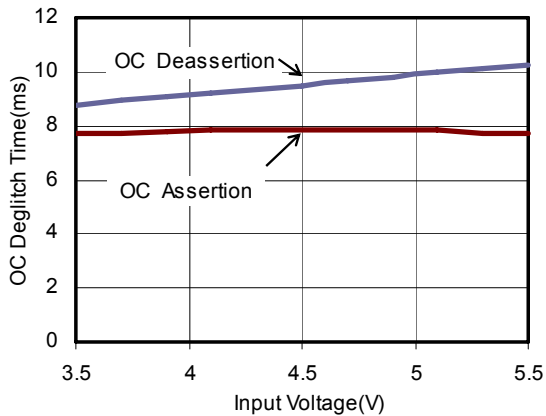

**UVLO Threshold vs. Temperature**

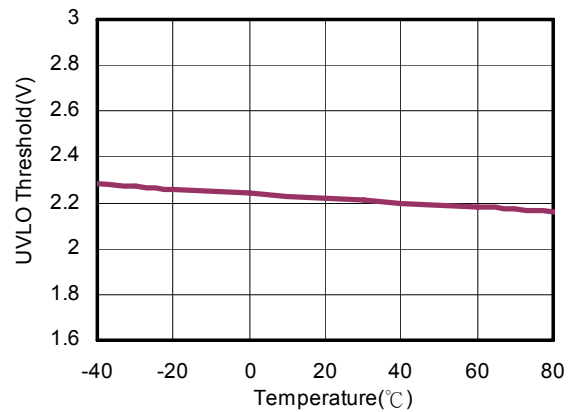

Typical Performance Characteristics (Continued)

ON-Resistance vs. Input Voltage

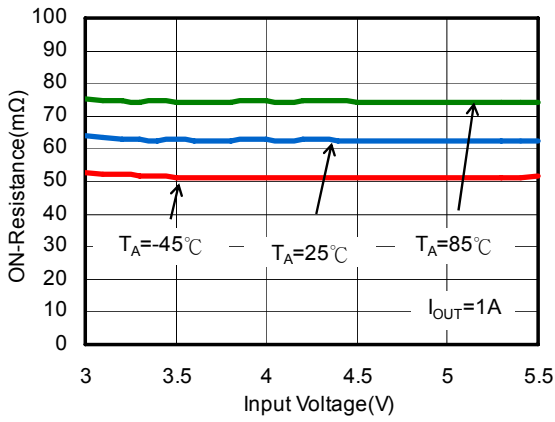

ON-Resistance vs. Temperature

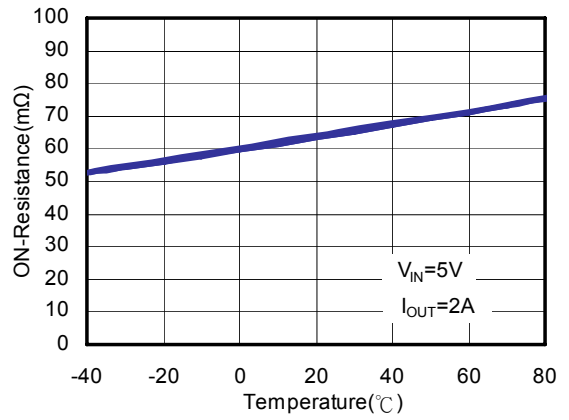

Over Current Trigger Point vs. Input Voltage

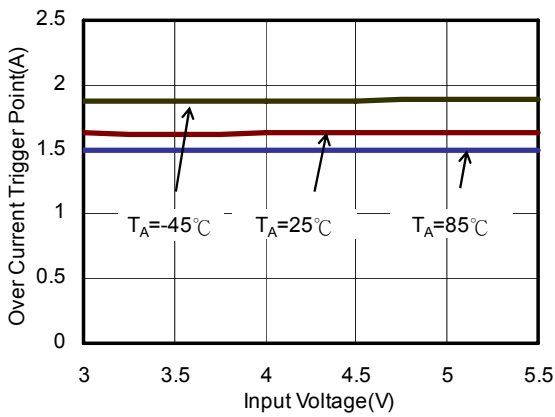

Short Circuit Current vs. Input Voltage

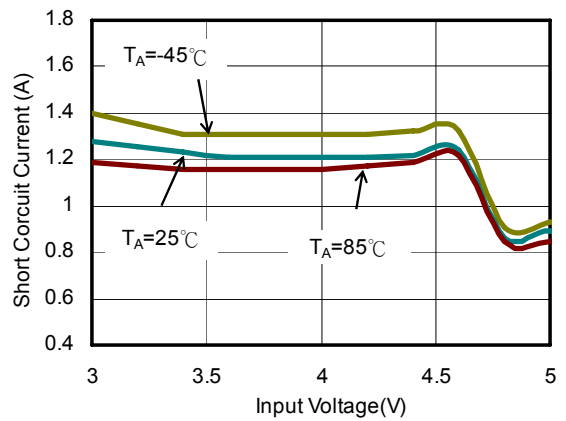

Overcurrent Protection Characteristics

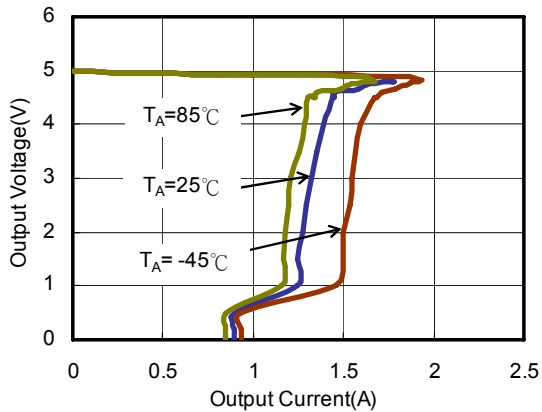

Overcurrent Protection Characteristics

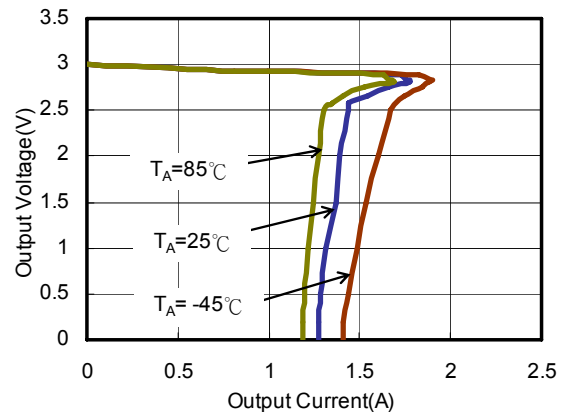

Typical Performance Characteristics (Continued)

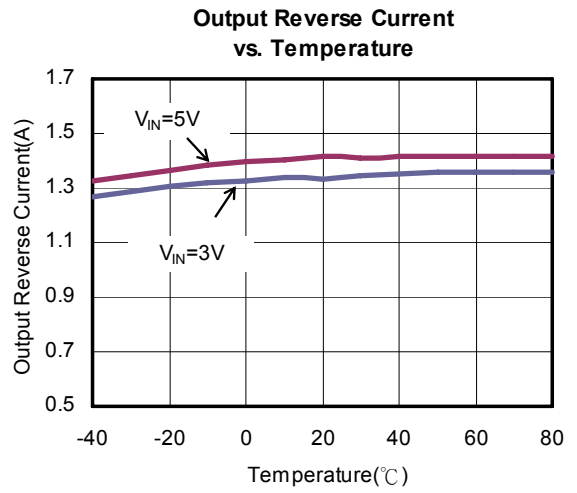
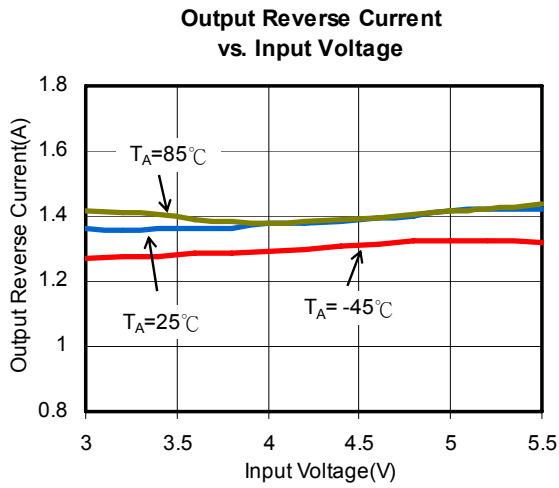

Typical Performance Characteristics (Continued)

Turn on Delay Time and Rise Time

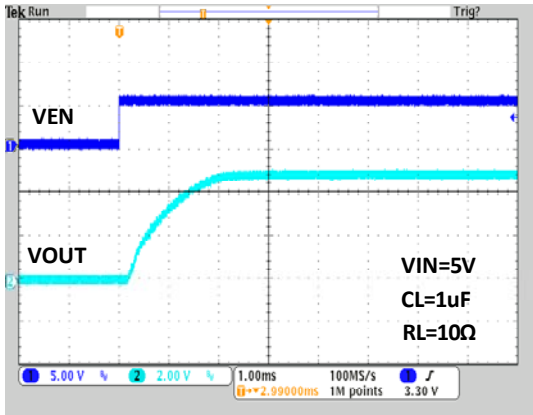

Turn off Delay Time and Fall Time

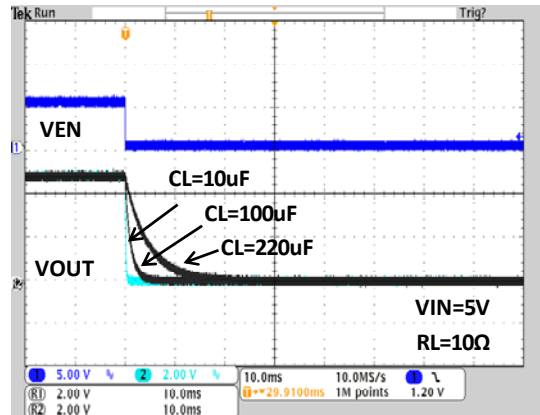

Inrush Current with Load Capacitance

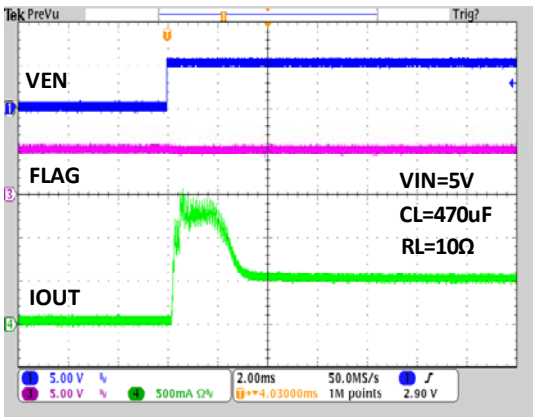

Thermal shutdown Response

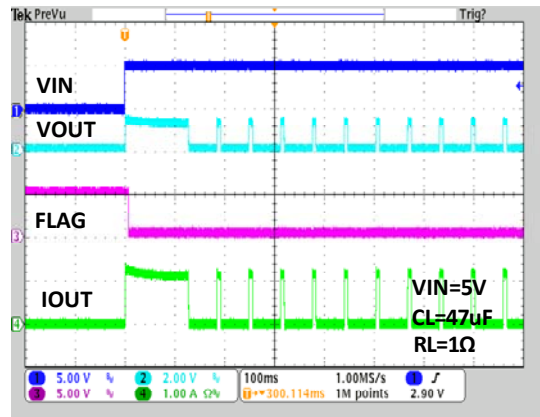

UVLO Protection at Rising

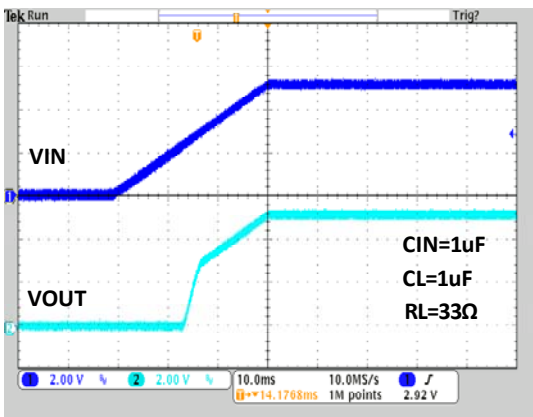

UVLO Protection at Falling

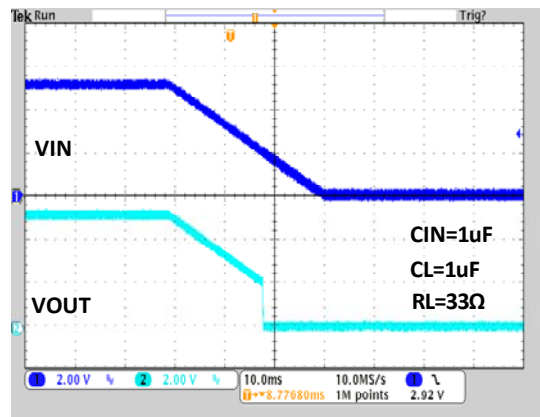



Typical Performance Characteristics (Continued)

Inrush Short Circuit Response

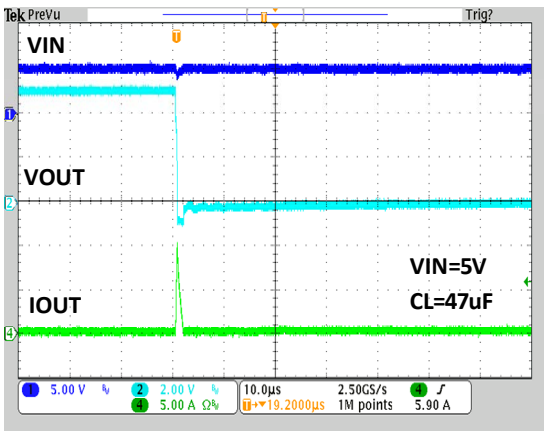

Resistance Load Inrush Response

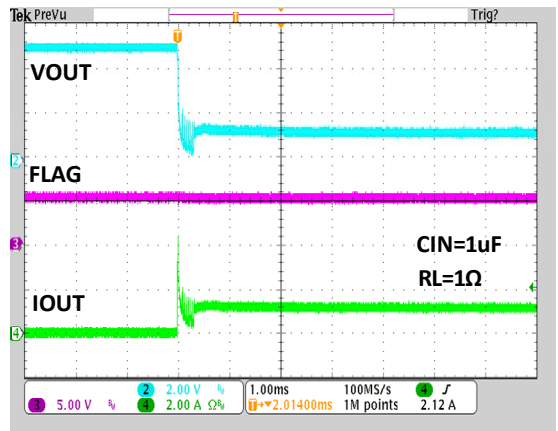

Short-Circuit Current, Device Enable into Short

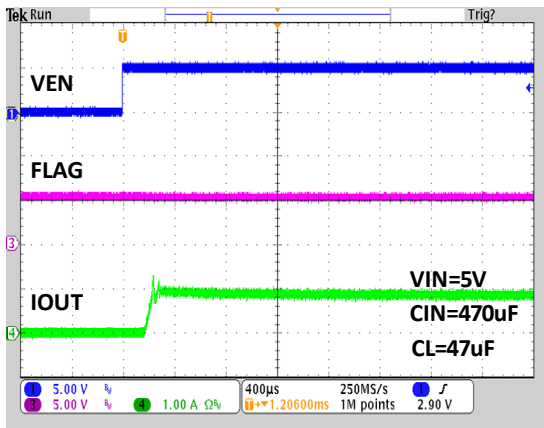

Short Circuit Response at Start up

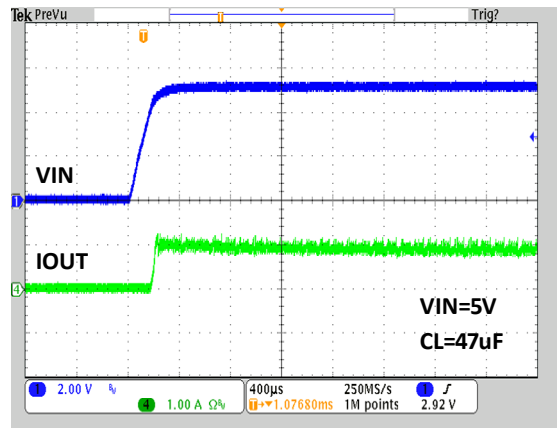

Reverse-Voltage Protection Response

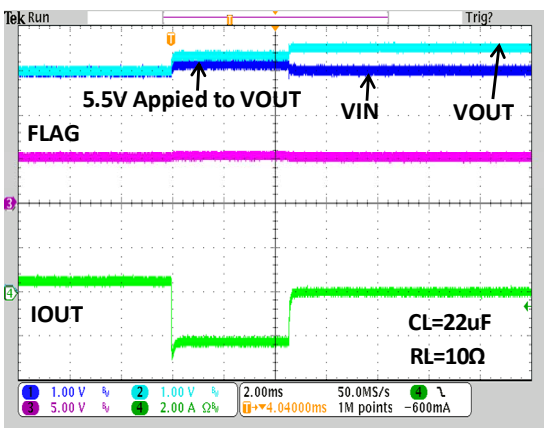

Reverse-Voltage Protection Recovery

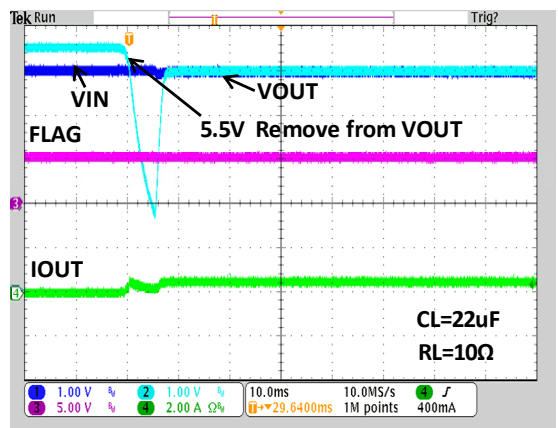

**Typical Performance Characteristics (Continued)**  
G517G,  $V_{IN}=5V$ ,  $C_{IN}=1\mu F$ ,  $C_{OUT}=1\mu F$ ,  $T_A=25^\circ C$ , unless otherwise noted.

**Supply Current vs. Input Voltage**

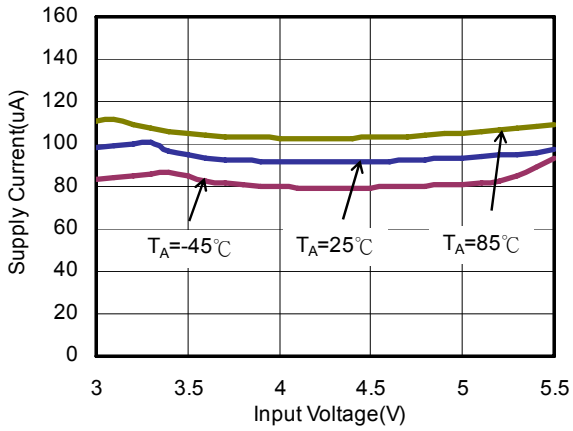

**Shutdown Supply Current vs. Input Voltage**

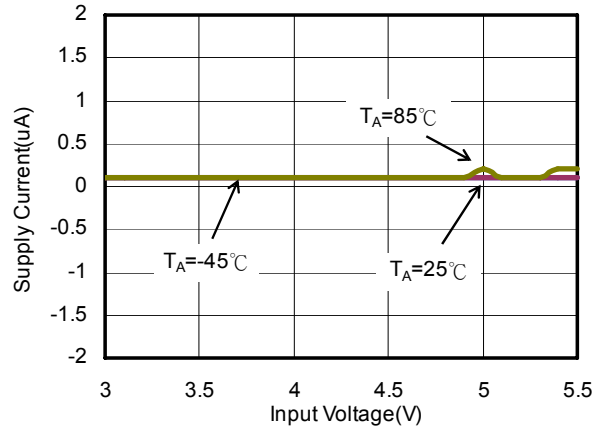

**Enable Input Threshold vs. Input Voltage**

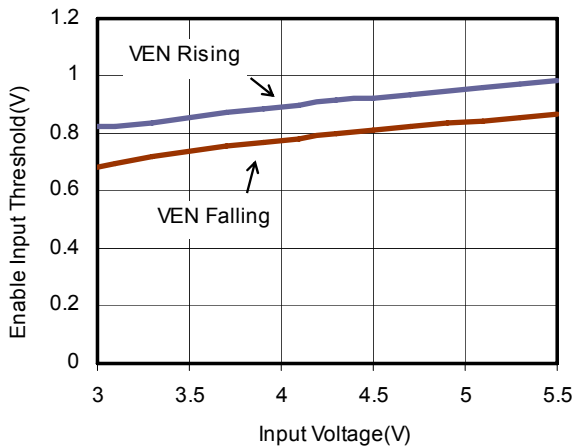

**Enable Input Threshold vs. Temperature**

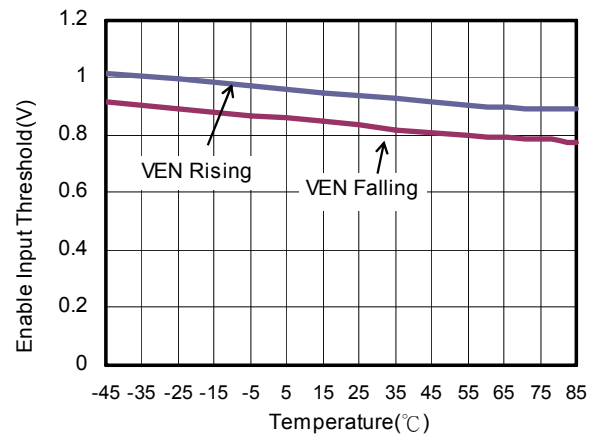

**OC Deglitch Time vs. Input Voltage**

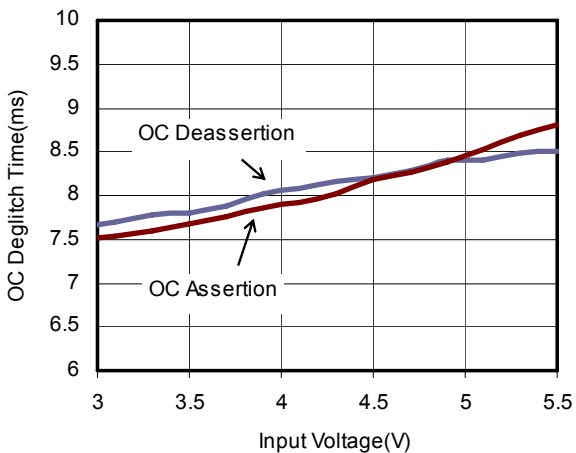

**UVLO Threshold vs. Temperature**

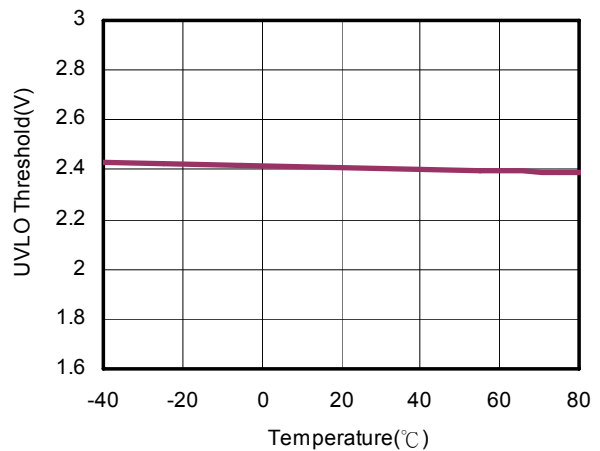

**Typical Performance Characteristics (Continued)**

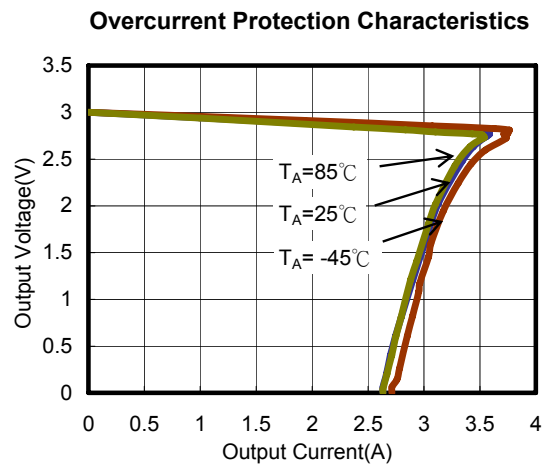
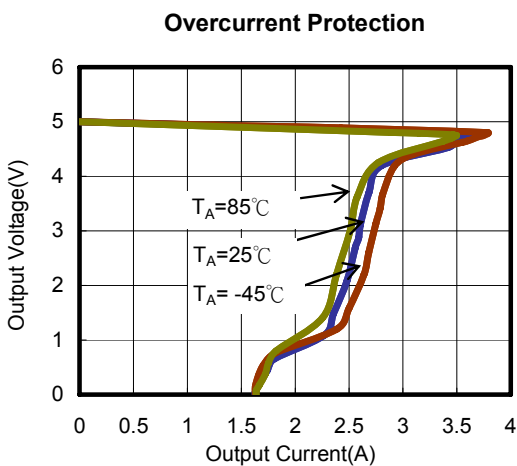
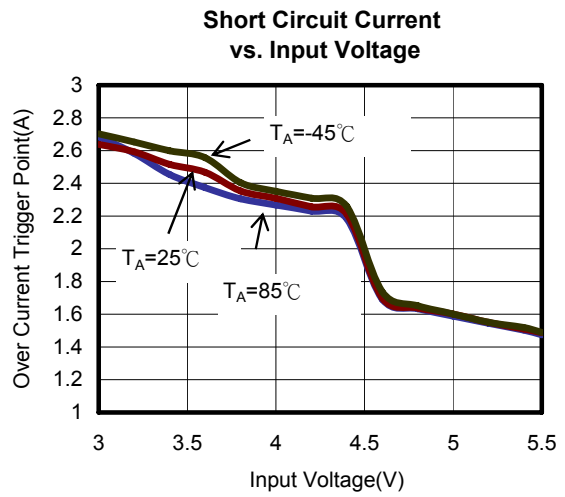
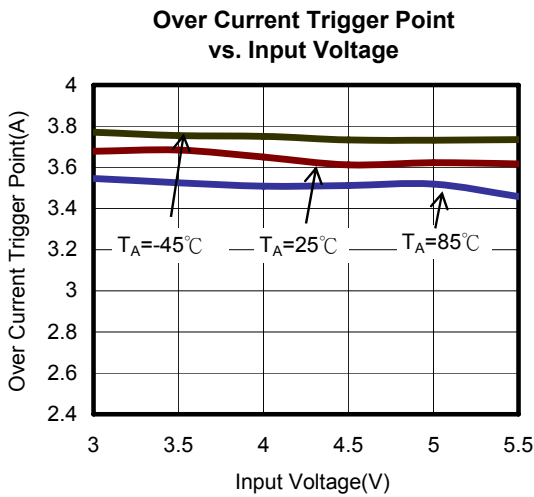
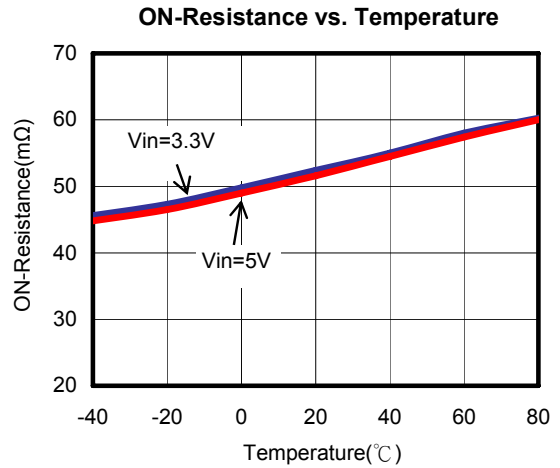
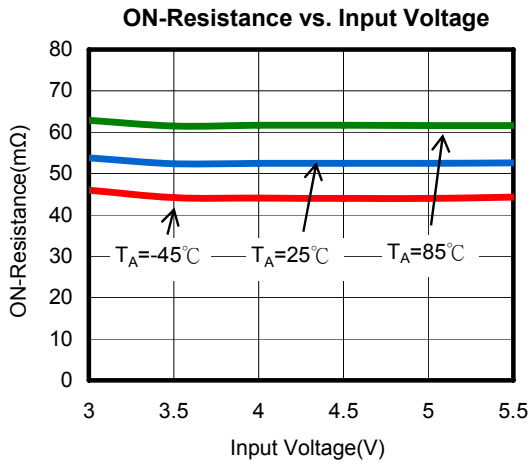

Typical Performance Characteristics (Continued)

Output Reverse Current vs. Input Voltage

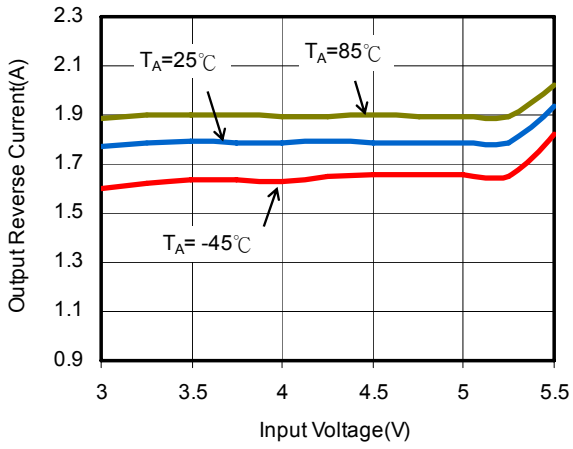

Output Reverse Current vs. Temperature

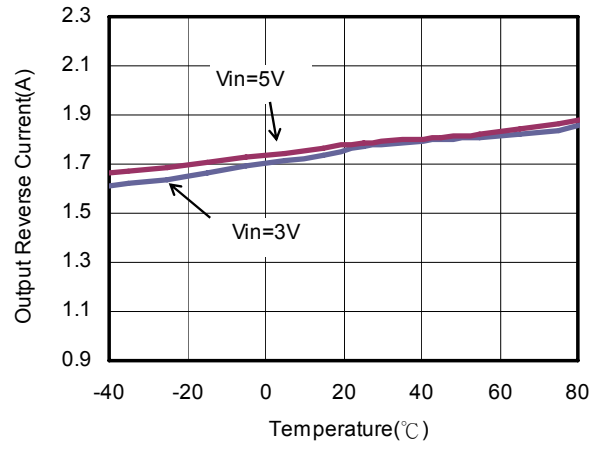

Typical Performance Characteristics (Continued)

Turn on Delay Time and Rise Time

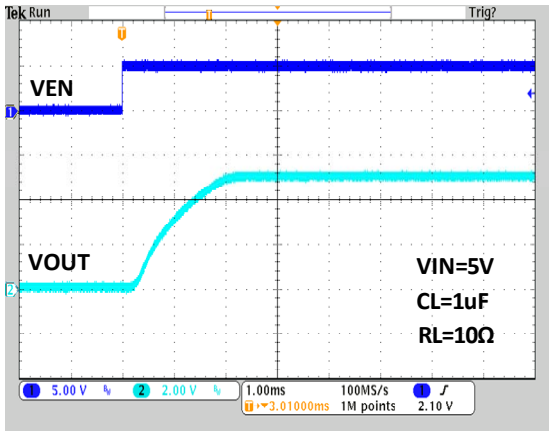

Turn off Delay Time and Fall Time

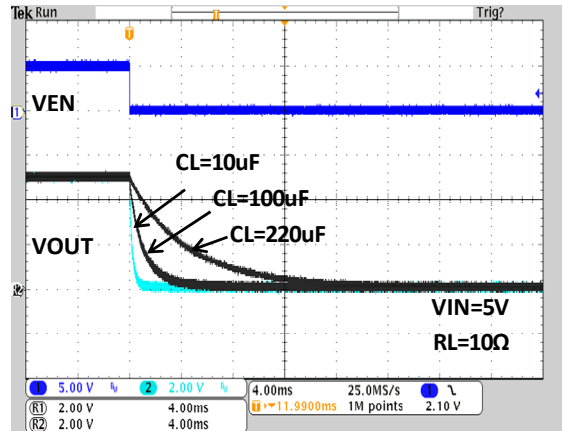

Inrush Current with Load Capacitance

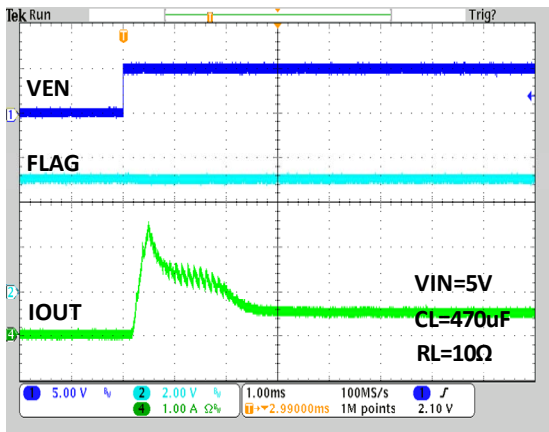

Thermal shutdown Reponse

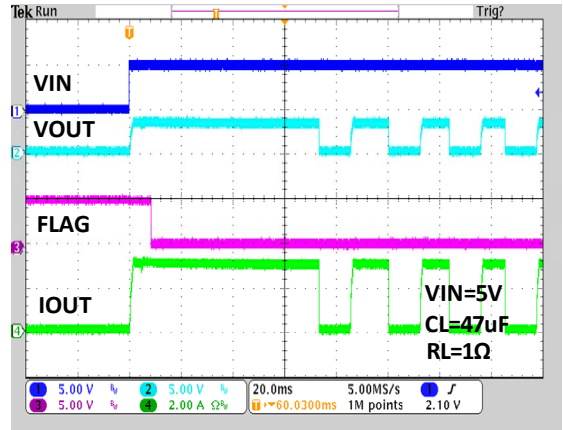

UVLO Protection at Rising

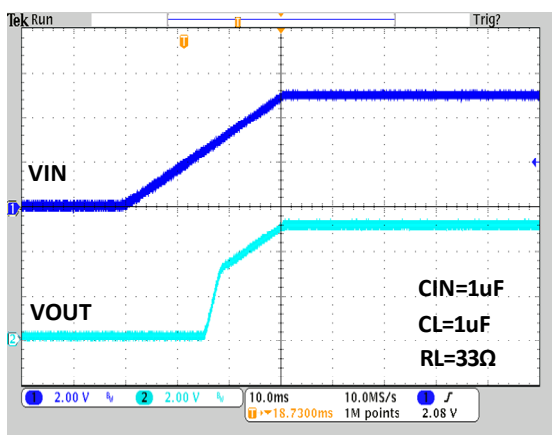

UVLO Protection at Falling

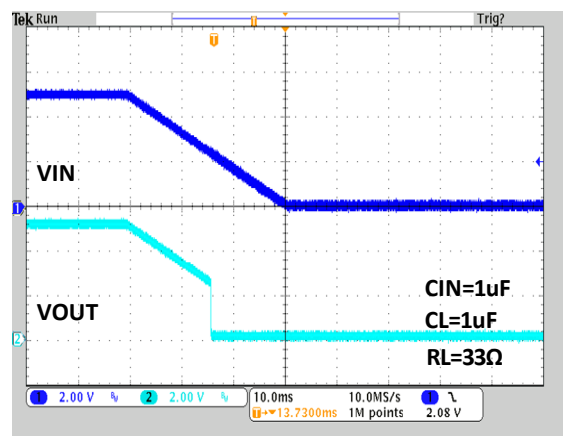

Typical Performance Characteristics (Continued)

Inrush Short Circuit Response

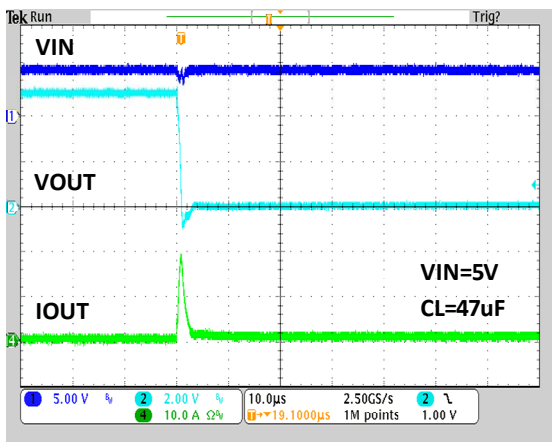

Resistance Load Inrush Response

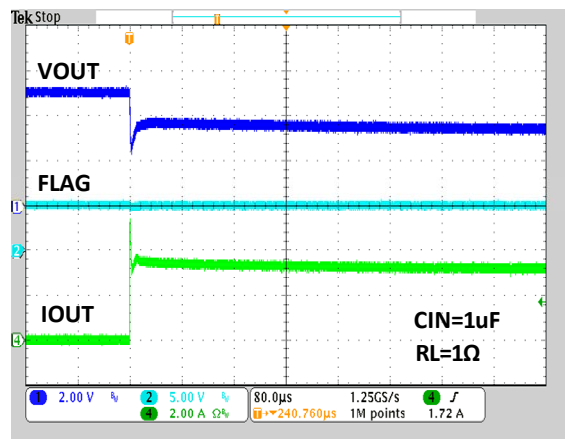

Short-Circuit Current, Device Enable into Short

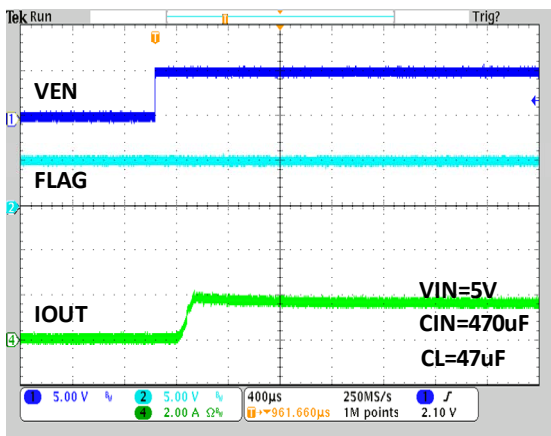

Short Circuit Response at Start up

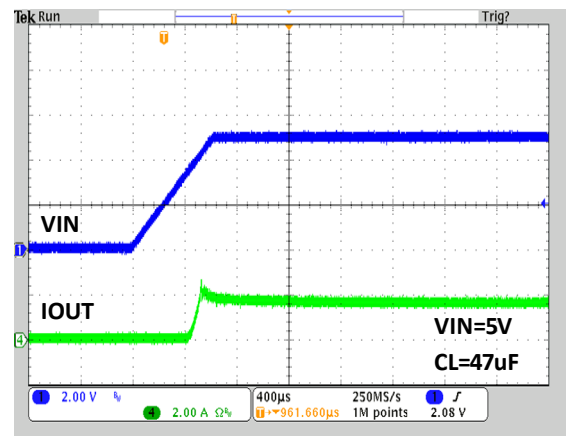

Capacitance Load Inrush Response

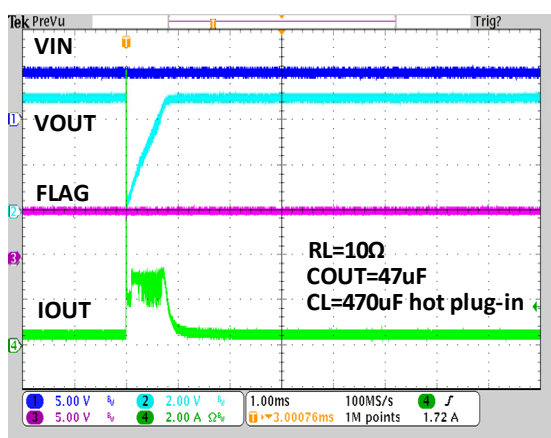

Capacitance Load Inrush Response

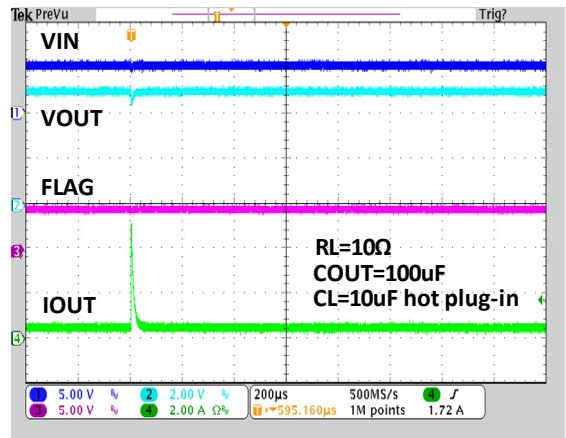

Typical Performance Characteristics (Continued)

Reverse-Voltage Protection Response

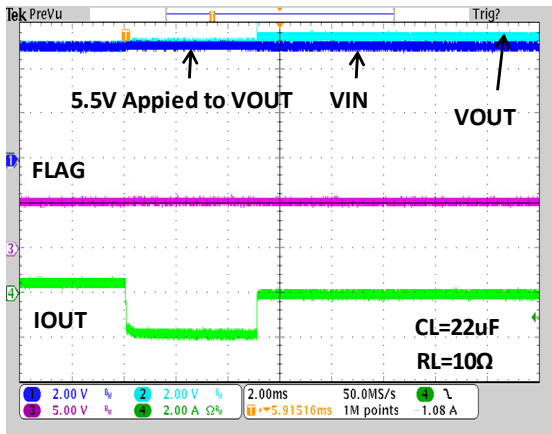

Reverse-Voltage Protection Recovery

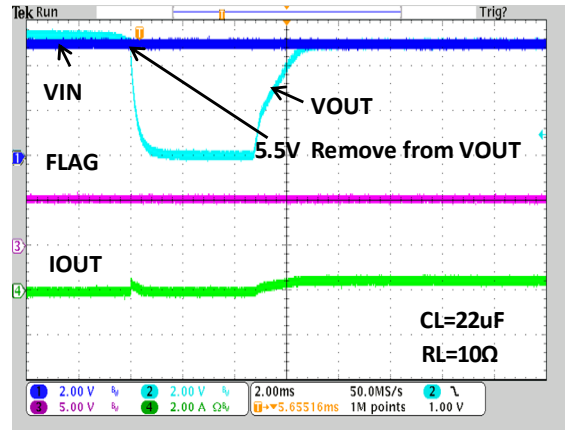

## Pin Description (G517AH)

PIN		NAME	FUNCTION
SOT-23-6/TSOT-23-6	TDFN2x2-6		
1	6	OUT	Switch Output
2	2	GND	Ground
3	4	FLAG/EN	A bi-directional interface pin. As an output pin, voltage becomes low to indicate overcurrent and thermal shutdown. As an input pin, high voltage level enables chip and low voltage level disables chip
4	3	DSG	External resistor utilized to set output discharge current
5	5	SET	Current limit set input
6	1	IN	Supply Voltage
	Thermal Pad		Recommend connecting the Thermal Pad to the GND for excellent power dissipation.

## Pin Description (G517AL)

PIN		NAME	FUNCTION
SOT-23-6/TSOT-23-6	TDFN2x2-6		
6	1	OUT	Switch Output
2	5	GND	Ground
4	3	FLAG	Open-Drain Fault Flag (Output): Indicates overcurrent, thermal shutdown
3	4	EN( $\overline{\text{EN}}$ )	Enable Logic Input
5	2	SET	Current limit set input
1	6	IN	Supply Voltage
	Thermal Pad		Recommend connecting the Thermal Pad to the GND for excellent power dissipation.

## Pin Description (G517B/C/D/E/F/G)

PIN				NAME	PIN FUNCTION
SOT-23-5/TSOT-23-5	TSOT-23-6	MSOP-8	WDFN2x2-6		
2	2	1	1	GND	
5	6	2,3	2	IN	<b>Input Supply:</b> Output MOSFET Drain, which also supplies IC's internal circuitry. Connect to positive supply.
4	4	4	3	EN( $\overline{\text{EN}}$ )	<b>Enable:</b> Logic level enable input. Make sure EN pin never floating.
3	3	5	4	FLAG	<b>Over-Current:</b> Open-Drain FLAG output.
1	1	6,7,8	5,6	OUT	<b>Switch Output:</b> Output MOSFET Source of switch. Typically connect to switched side of load.
			Thermal Pad		Recommend connecting the Thermal Pad to the GND for excellent power dissipation.



**Block Diagrams (G517AH)**

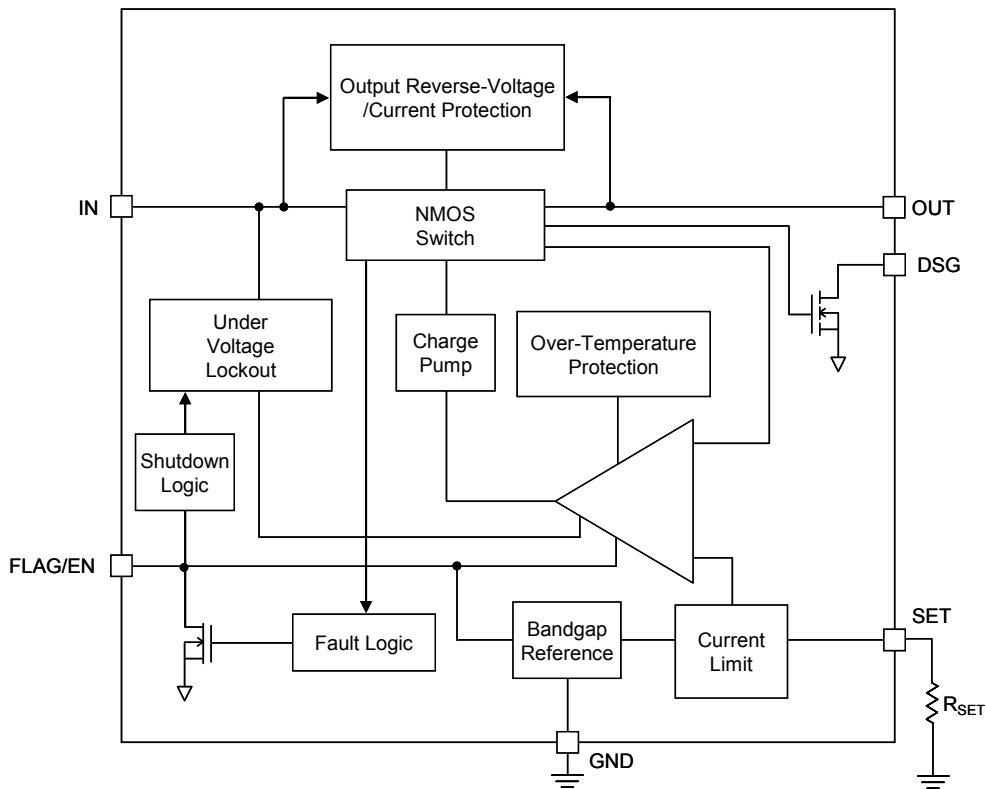

**Block Diagrams (G517AL)**

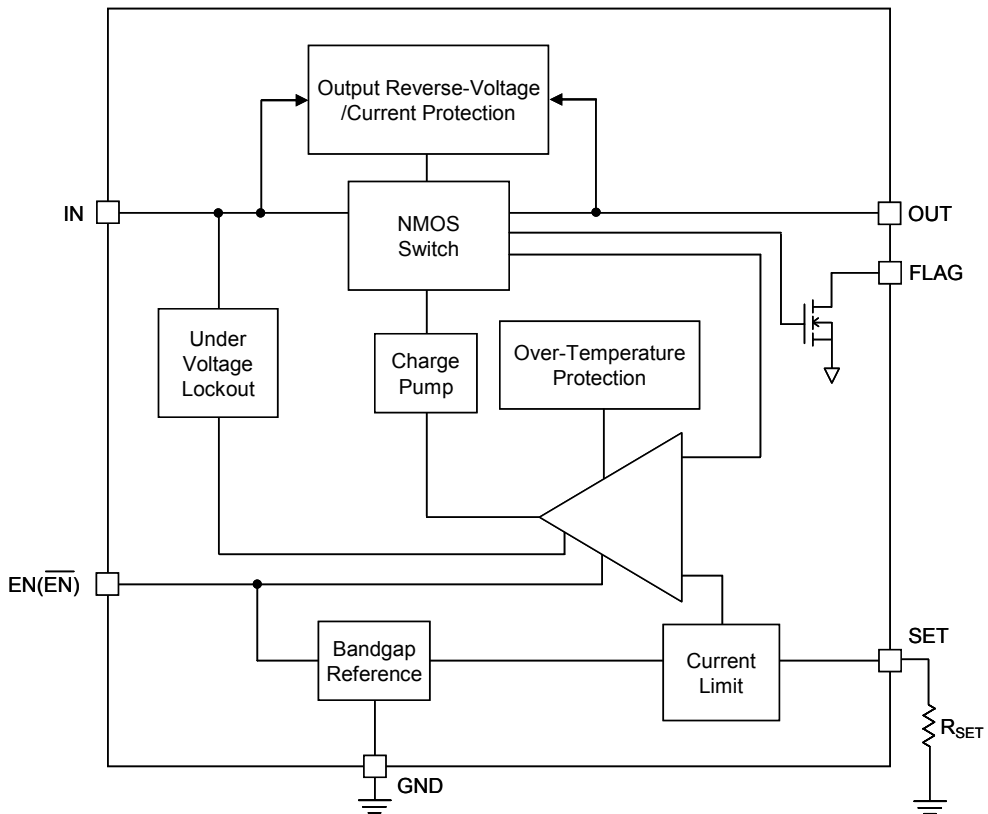

**Block Diagram (G517B/C/D/E/F/G)**

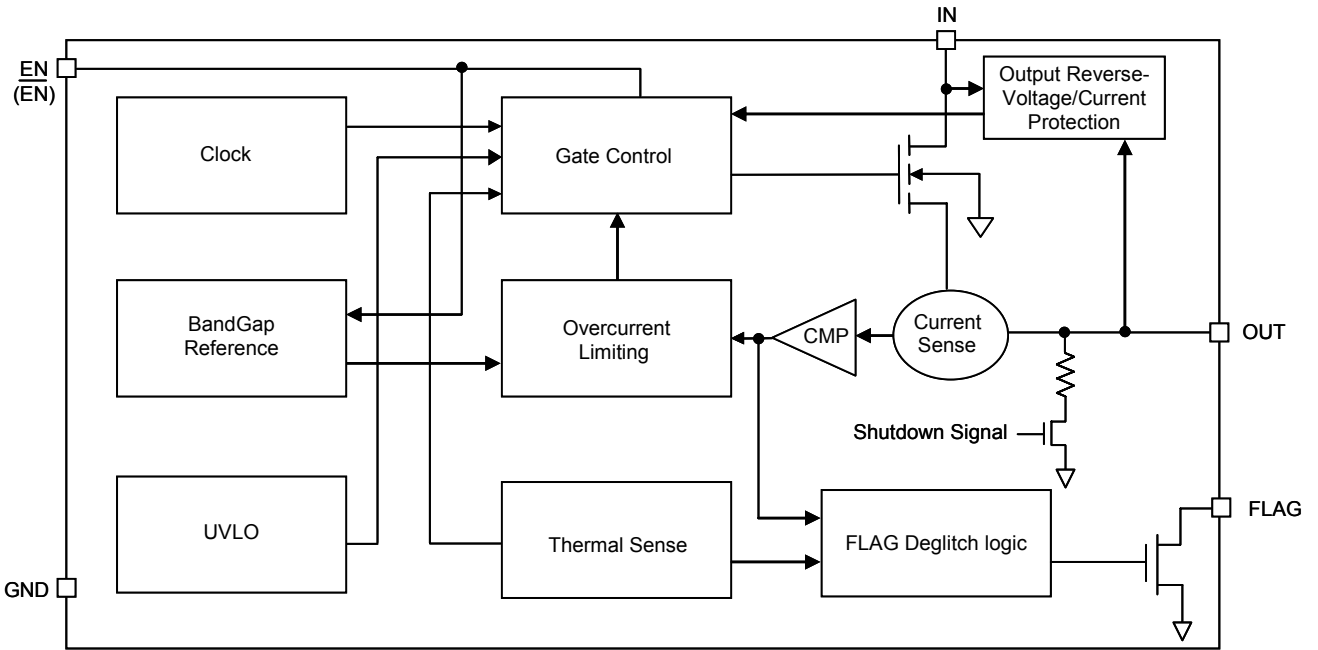

## Functional Description

### Input and Output

IN (input) is the power supply connection to the logic circuitry and the drain of the output MOSFET. OUT (output) is the source of the output MOSFET. In a typical application, current flows through the switch from IN to OUT toward the load. Both OUT pins must be connected together to the load.

### Thermal Shutdown

Thermal shutdown protects G517AH/AL/BCDEFG from excessive power dissipation. If the die temperature exceeds aforementioned OT spec., the MOSFETS switch is shut off. The hysteresis prevents the switch from turning on until the die temperature drops to  $OT_{HYS}$ . Thermal shutdown circuit functions only when the switch is enabled.

### Undervoltage Lockout

UVLO (undervoltage lockout) prevents the output MOSFET from turning on until IN (input voltage) exceeds 2.1/2.4V typically. After the switch turns on, if the voltage drops below 2.1/2.4V typically, UVLO shuts off the output MOSFET.

### Over Current Trigger Point (G517AH)

The G517AH over current trigger point is programmed with a resistor from SET to ground. The typical value is determined by  $R_{SET}$ . We can choose the proper  $R_{SET}$  by Table1.

### Over Current Trigger Point (G517AL)

The G517AL over current trigger point is programmed with a resistor from SET to ground. The typical value is determined by  $R_{SET}$ . We can choose the proper  $R_{SET}$  by Table2. There is short-circuit fold-back current limit when  $V_{IN} > 3.5V$  and  $V_{OUT} < 1V$ .

### Over Current Trigger Point (G517B/C/D/E/F/G)

The typical over current trigger point of G517 is 3.4A, 2.5A, 1.8A, 1.3A, 0.8A, 0.4A. There is short-circuit fold-back current when  $V_{IN} > 3.5V$  and  $V_{OUT} < 1V$ . (See Typical Performance Characteristics)

### Output Reverse-Voltage/Current Protection

The output reverse-voltage protection turns off the MOSFET switch whenever the output voltage is higher than the input voltage by 60mV (typ) for 0.7/5/5ms (typ) and the MOSFET switch will turn on when output reverse-voltage/current condition is removed for 0.7/5/5ms (typ).

### Discharge Function (G517AH)

When the device is disabled or IN is below UVLO threshold, the discharge function is active. The discharge function provides a discharge path for external storage capacitor by connecting a resistor between OUT and DSG.

### FLAG Function

The FLAG open-drain output is asserted (active low) when an over current condition is encountered after a 9-ms deglitch timeout. The output remains asserted until the overcurrent condition is removed. Over temperature condition is also reported immediately by FLAG open-drain output.

### Over Current Regulation and Protection (G517AL)

In over current condition, the temperature of the chip will rise. It results in thermal shutdown of the MOSFETS switch as over current condition is not removed. Then, the device enters in over current regulation and protection modes. In over current regulation mode, the current is regulated to the desired over current level and the MOSFETS switch is turned off in over current protection mode. The over current regulation and protection modes allow the device to release high thermal dissipation within temperature operation condition.

### FLAG/EN Function (G517AH)

This pin serves as both an input and output pin. The FLAG/EN output is asserted (active low) when an over current condition is encountered after a 3ms deglitch timeout. The output remains asserted until the IN voltage is below UVLO to reset the switch. Over temperature condition is also reported immediately by FLAG/EN open-drain output. The FLAG/EN input is inactive with low voltage level and active with high voltage level.

### Soft-Start Protection (G517AH)

When power switch turns on, the soft-start protection is utilized to ensure 5ms(typ) on-time of power switch and all operation of G517AH is recommended to be performed after this soft-start protection.

## Applications Information

### Supply Filtering

A 1 $\mu$ F bypass capacitor from IN to GND, located near the G517, is strongly recommended to control supply transients. Without a bypass capacitor, an output short may cause sufficient ringing on the input (from supply lead inductance) to damage internal control circuitry.

Input transients must not exceed the absolute maximum supply voltage ( $V_{IN\ max} = 6V$ ) even for a short duration.

### EN, the Enable Input

EN must be driven logic high or logic low for a clearly defined input. Floating the input may cause unpredictable operation. EN should not be allowed to go negative with respect to GND.

**Table 1. Current Limit RSET Value for G517AH**

RSET(kΩ)	Current Limit Min (A)	Current Limit Typ (A)	Current Limit Max (A)
7.68	2.43	2.7	2.97
8.25	2.25	2.5	2.75
9.53	1.98	2.2	2.42
10.5	1.8	2	2.2
11.5	1.62	1.8	1.98
14.3	1.35	1.5	1.65
17.4	1.08	1.2	1.32
21	0.9	1	1.1
34.8	0.5	0.6	0.7
42	0.4	0.5	0.6

Note: The Relationship between RSET (KΩ) and Typical Current Limit (A) is about Current Limit =21/RSET

**Table 2. Current Limit RSET Value for G517AL**

RSET(kΩ)	Current Limit Min (A)	Current Limit Typ (A)	Current Limit Max (A)
11	2.25	2.5	2.75
24.9	0.9	1.0	1.1
37.4	0.6	0.7	0.8
49.9	0.425	0.5	0.575
100	0.175	0.25	0.325

Note: The Relationship between RSET (KΩ) and Typical Current Limit (A) is about Current Limit =30.9/(RSET)<sup>1.05</sup>

**Test Circuit**

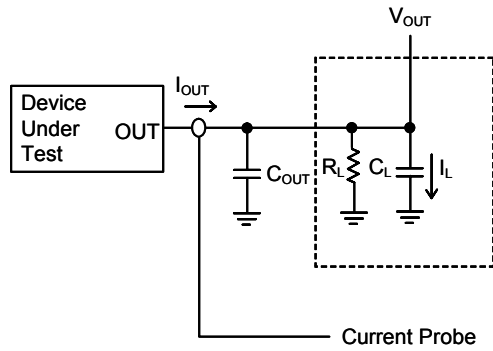

**Timing Diagrams**

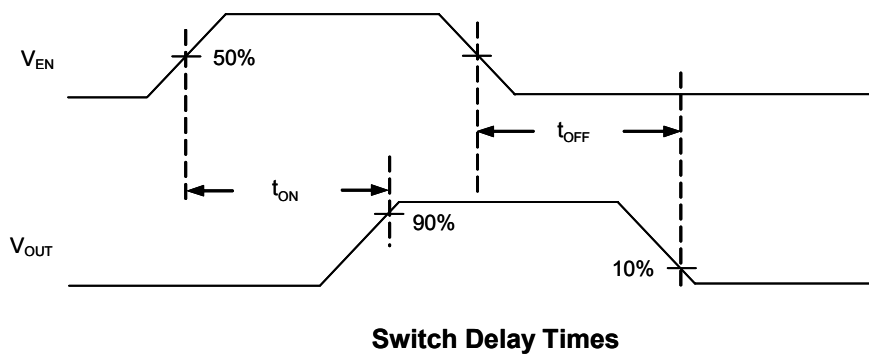
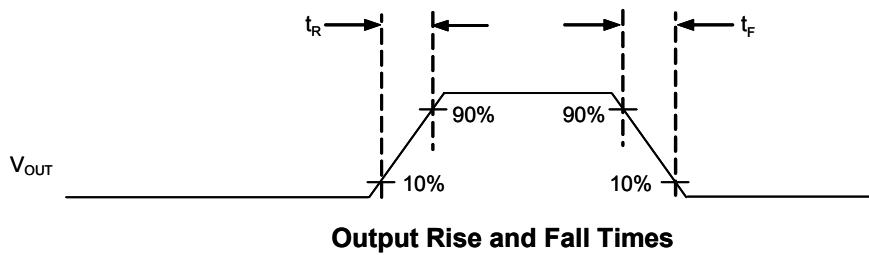

## Package Information

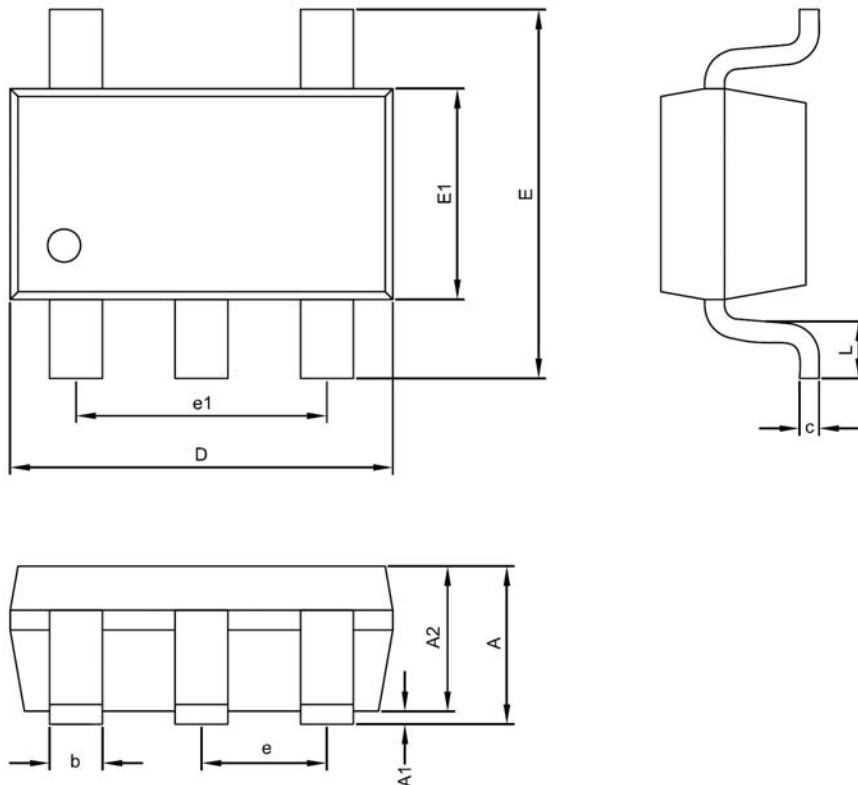

SOT-23-5 Package

Symble	DIMENSION IN MM			DIMENSION IN INCH		
	MIN.	NOM.	MAX.	MIN.	NOM.	MAX.
A	1.00	1.10	1.45	0.039	0.043	0.057
A1	0.00	---	0.10	0.000	---	0.004
A2	1.00	1.10	1.30	0.039	0.043	0.051
D	2.70	2.90	3.10	0.106	0.114	0.122
E	2.60	2.80	3.00	0.102	0.110	0.118
E1	1.50	1.60	1.70	0.059	0.063	0.067
c	0.08	0.15	0.25	0.003	0.006	0.010
b	0.30	0.40	0.50	0.012	0.016	0.020
e	0.95 BSC			0.037 BSC		
e1	1.90 BSC			0.075 BSC		
L	0.30	0.45	0.60	0.012	0.018	0.024

## Taping Specification

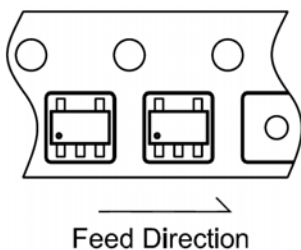

PACKAGE	Q'TY/REEL
SOT-23-5	3,000 ea

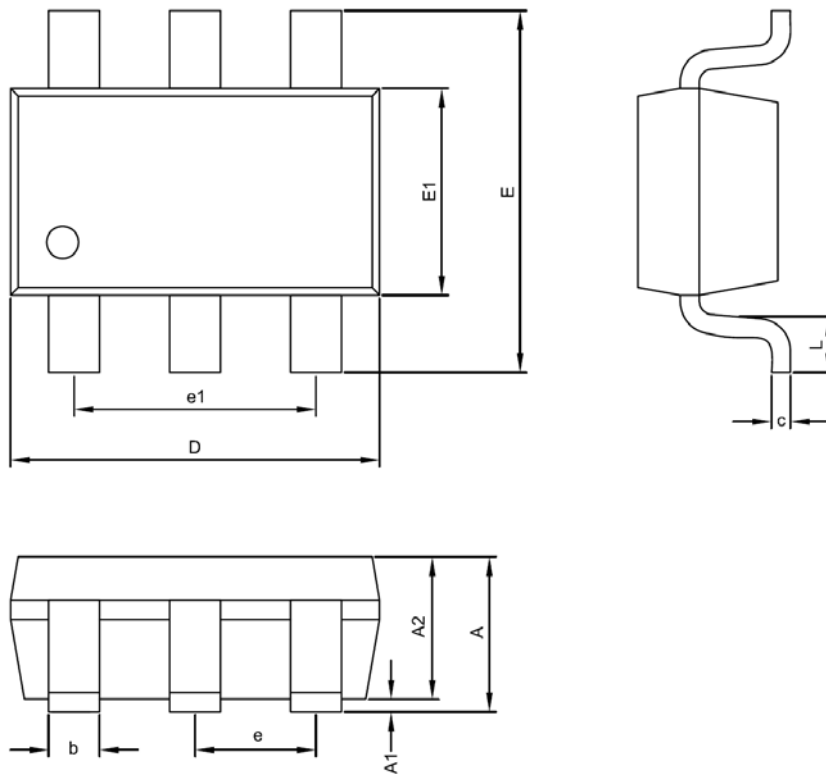

**SOT-23-6 Package**

Symble	DIMENSION IN MM			DIMENSION IN INCH		
	MIN.	NOM.	MAX.	MIN.	NOM.	MAX.
A	1.00	1.10	1.45	0.039	0.043	0.057
A1	0.00	---	0.15	0.000	---	0.006
A2	1.00	1.10	1.30	0.039	0.043	0.051
D	2.70	2.90	3.10	0.106	0.114	0.122
E	2.60	2.80	3.00	0.102	0.110	0.118
E1	1.50	1.60	1.70	0.059	0.063	0.067
c	0.08	0.15	0.25	0.003	0.006	0.010
b	0.30	0.40	0.50	0.012	0.016	0.020
e	0.95 BSC			0.037 BSC		
e1	1.90 BSC			0.075 BSC		
L	0.30	0.45	0.60	0.012	0.018	0.024

**Taping Specification**

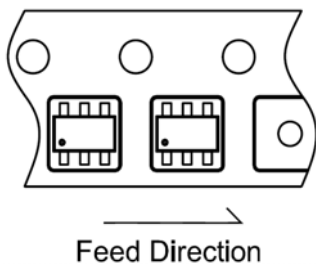

PACKAGE	Q'TY/REEL
SOT-23-6	3,000 ea

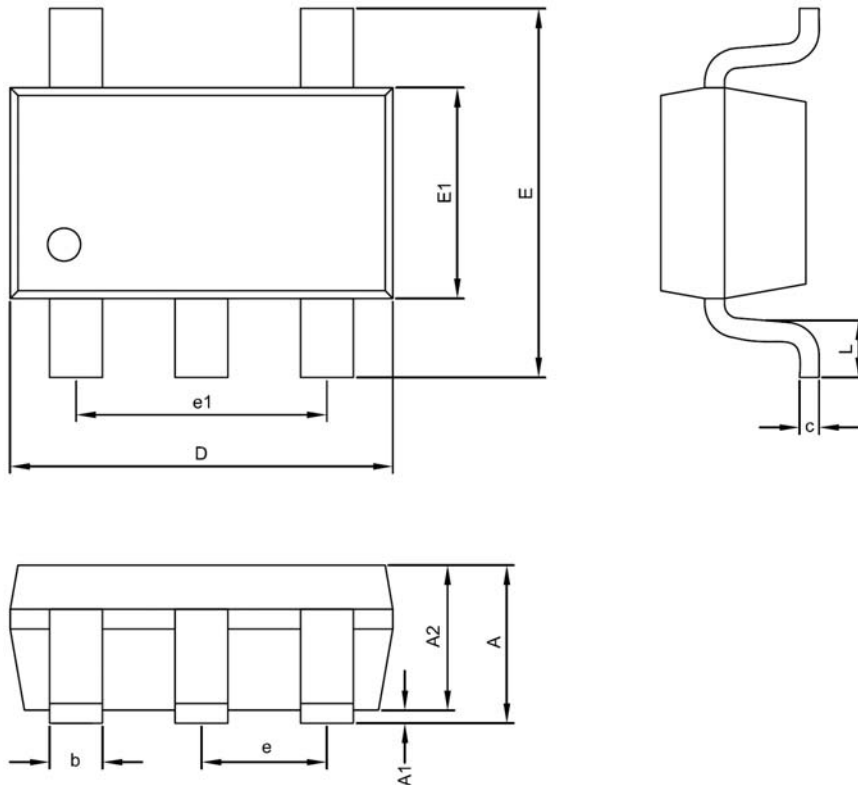

TSOT-23-5 Package

Symble	DIMENSION IN MM			DIMENSION IN INCH		
	MIN.	NOM.	MAX.	MIN.	NOM.	MAX.
A	---	---	0.90	---	---	0.035
A1	0.00	0.05	0.10	0.000	0.002	0.004
A2	0.70	0.75	0.80	0.028	0.030	0.031
D	2.70	2.90	3.10	0.106	0.114	0.122
E	2.60	2.80	3.00	0.102	0.110	0.118
E1	1.50	1.60	1.70	0.059	0.063	0.067
c	0.08	0.15	0.25	0.003	0.006	0.010
b	0.30	0.40	0.50	0.012	0.016	0.020
e	0.95 BSC			0.037 BSC		
e1	1.90 BSC			0.075 BSC		
L	0.30	0.45	0.60	0.012	0.018	0.024

## Taping Specification

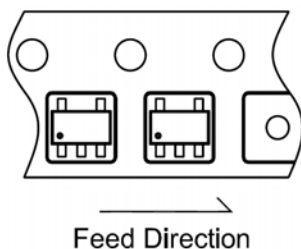

PACKAGE	Q'TY/REEL
TSOT-23-5	3,000 ea



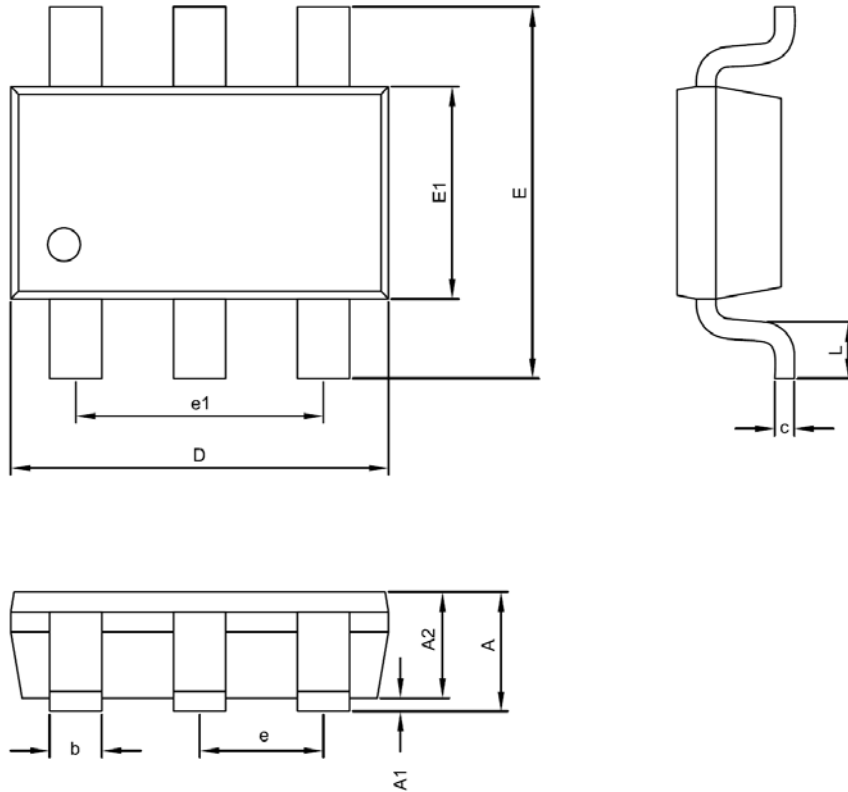

TSOT-23-6 Package

Symble	DIMENSION IN MM			DIMENSION IN INCH		
	MIN.	NOM.	MAX.	MIN.	NOM.	MAX.
A	---	---	0.90	---	---	0.035
A1	0.00	0.05	0.10	0.000	0.002	0.004
A2	0.70	0.75	0.80	0.028	0.030	0.031
D	2.70	2.90	3.10	0.106	0.114	0.122
E	2.60	2.80	3.00	0.102	0.110	0.118
E1	1.50	1.60	1.70	0.059	0.063	0.067
c	0.08	0.15	0.25	0.003	0.006	0.010
b	0.30	0.40	0.50	0.012	0.016	0.020
e	0.95 BSC			0.037 BSC		
e1	1.90 BSC			0.075 BSC		
L	0.30	0.45	0.60	0.012	0.018	0.024

## Taping Specification

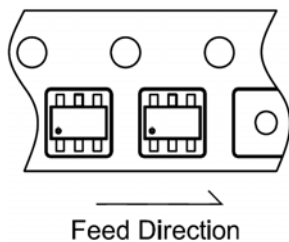

PACKAGE	Q'TY/REEL
TSOT-23-6	3,000 ea

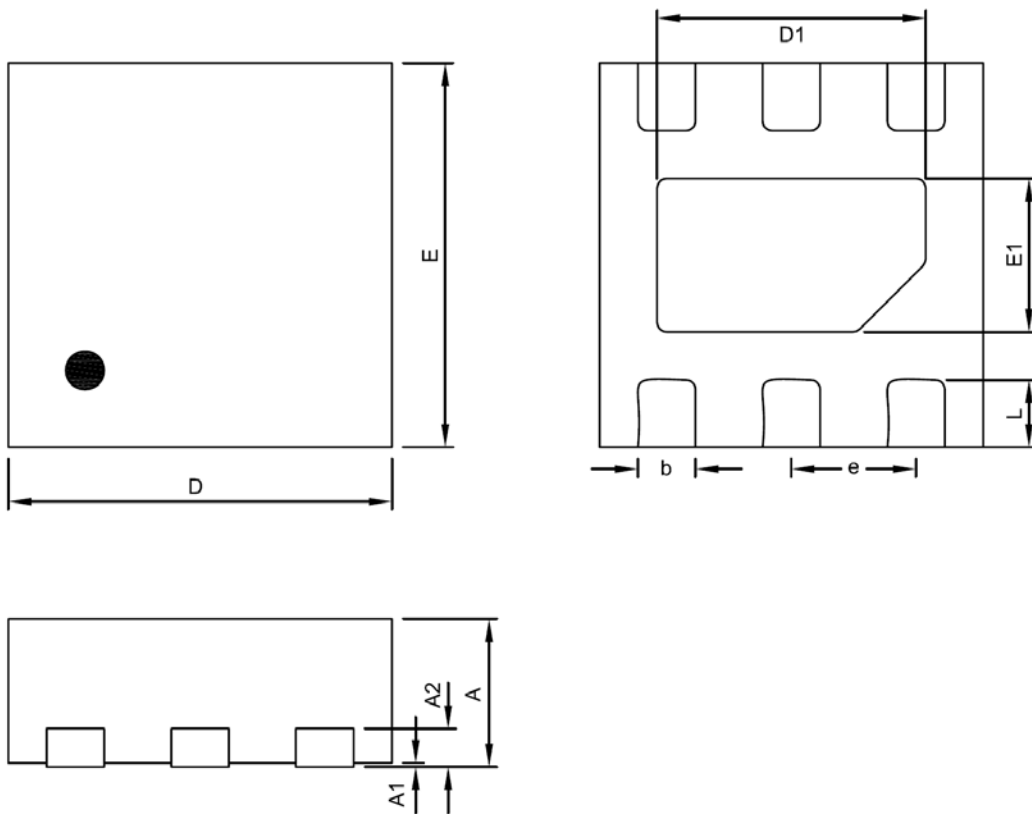

TDFN2X2-6 Package

Symble	DIMENSION IN MM			DIMENSION IN INCH		
	MIN.	NOM.	MAX.	MIN.	NOM.	MAX.
A	0.70	0.75	0.80	0.0276	0.0295	0.0315
A1	0.00	---	0.05	0.0000	---	0.0020
A2	0.19	0.20	0.21	0.0075	0.0079	0.0083
D	1.95	2.00	2.05	0.0768	0.0787	0.0807
E	1.95	2.00	2.05	0.0768	0.0787	0.0807
D1	1.15	1.30	1.45	0.0453	0.0512	0.0571
E1	0.55	0.70	0.85	0.0217	0.0276	0.0335
b	0.25	0.30	0.35	0.0098	0.0118	0.0138
e	0.65 BSC			0.0256 BSC		
L	0.30	0.35	0.40	0.0118	0.0138	0.0157

### Taping Specification

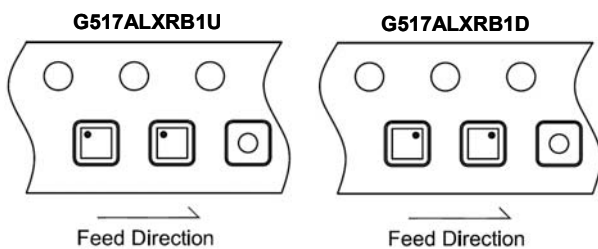

PACKAGE	Q'TY/REEL
TDFN2X2-6	3,000 ea

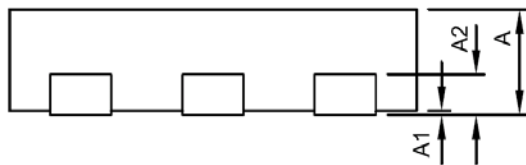
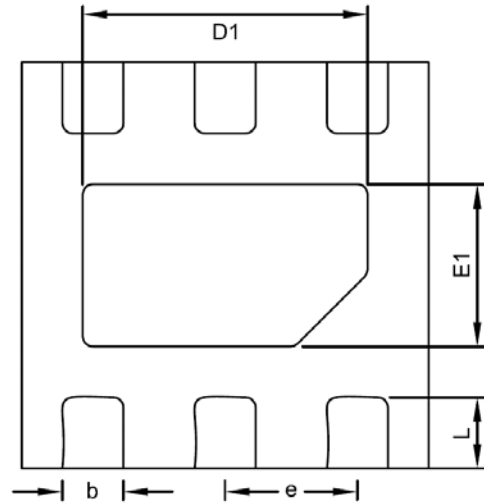
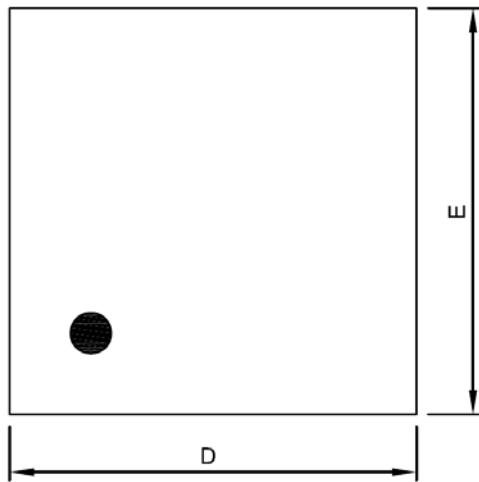

**WDFN2X2-6 Package**

Symble	DIMENSION IN MM			DIMENSION IN INCH		
	MIN.	NOM.	MAX.	MIN.	NOM.	MAX.
A	0.45	0.50	0.55	0.0177	0.0197	0.0217
A1	0.00	---	0.05	0.0000	---	0.0020
A2	0.19	0.20	0.21	0.0075	0.0079	0.0083
D	1.95	2.00	2.05	0.0768	0.0787	0.0807
E	1.95	2.00	2.05	0.0768	0.0787	0.0807
D1	1.30	1.40	1.50	0.0512	0.0551	0.0591
E1	0.70	0.80	0.90	0.0276	0.0315	0.0354
b	0.25	0.30	0.35	0.0098	0.0118	0.0138
e	0.65 BSC			0.0256 BSC		
L	0.30	0.35	0.40	0.0118	0.0138	0.0157

**Taping Specification**

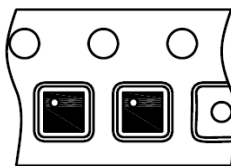

→  
Feed Direction

PACKAGE	Q'TY/REEL
WDFN2X2-6	3,000 ea

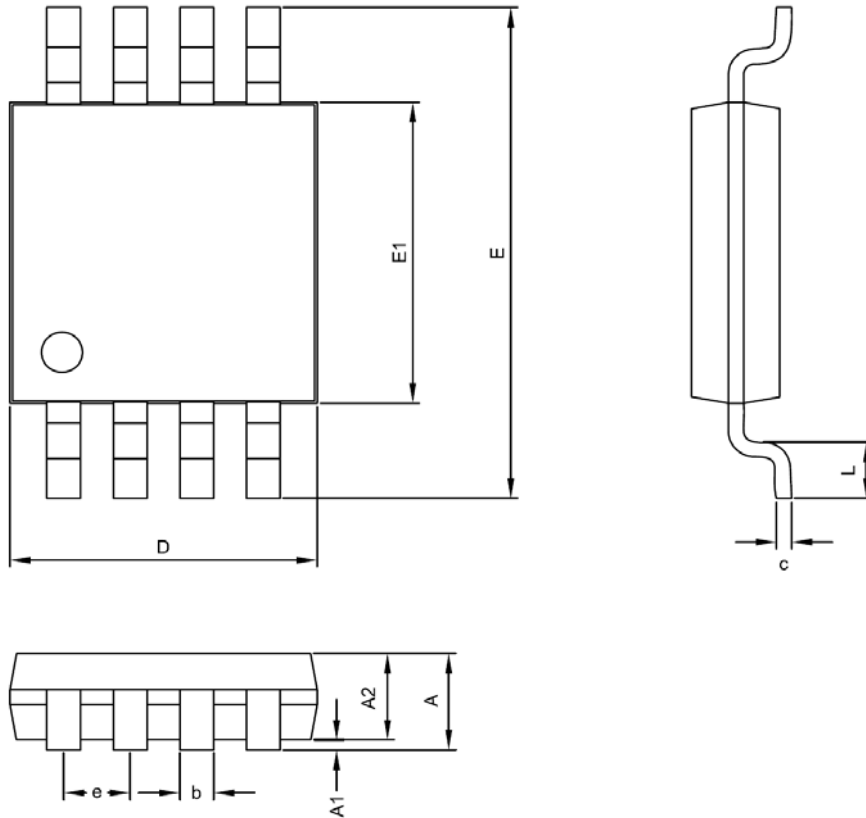
**MSOP-8 Package**

Symble	DIMENSION IN MM			DIMENSION IN INCH		
	MIN.	NOM.	MAX.	MIN.	NOM.	MAX.
A	0.81	0.95	1.10	0.032	0.037	0.043
A1	0.00	---	0.15	0.000	---	0.006
A2	0.76	0.86	0.96	0.030	0.034	0.038
D	2.85	3.00	3.15	0.112	0.118	0.124
E	4.75	4.90	5.05	0.187	0.193	0.199
E1	2.85	3.00	3.15	0.112	0.118	0.124
c	0.13	0.15	0.23	0.005	0.006	0.009
b	0.28	0.30	0.38	0.011	0.012	0.015
e	0.65 BSC			0.026 BSC		
L	0.4	0.53	0.8	0.016	0.021	0.031

### Taping Specification

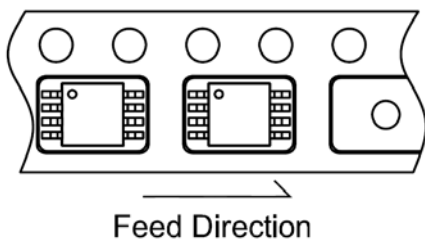

PACKAGE	Q'TY/REEL
MSOP-8	3,000 ea

GMT Inc. does not assume any responsibility for use of any circuitry described, no circuit patent licenses are implied and GMT Inc. reserves the right at any time without notice to change said circuitry and specifications.