

BRD30P06

Rev.D May.-2016

描述 / Descriptions

TO-252 塑封封装 P 沟道 MOS 场效应管。 P-CHANNEL MOSFET in a TO-252 Plastic Package.

特征 / Features

$V_{DS} = -60V, I_D = -26A$ $R_{DS(ON)} < 40m\Omega @ V_{GS} = -10V$ $R_{DS(ON)} < 55m\Omega @ V_{GS} = -4.5V$ 高功率和电流转移能力, 无铅产品, 表面贴装封装。

High Power and current handing capability, Lead free product is acquired, Surface Mount Package.

用途 / Applications

用于 PWM, 负载开关, 电源管理。

PWM applications, Load switch, Power management.

内部等效电路 / Equivalent Circuit

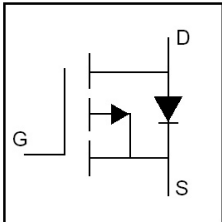

引脚排列 / Pinning

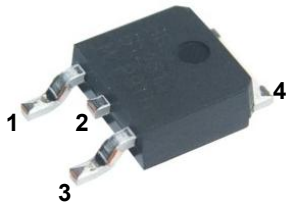

PIN 1 : G

PIN 2 : D

PIN 3 : S

PIN 4 : D

放大及印章代码 / h_{FE} Classifications & Marking

见印章说明。 See Marking Instructions.

极限参数 / Absolute Maximum Ratings(Ta=25°C)

参数 Parameter	符号 Symbol	数值 Rating	单位 Unit
Drain-Source Voltage	V_{DS}	-60	V
Drain Current	$I_D(T_C=25^\circ\text{C})$	-30	A
Drain Current	$I_D(T_C=70^\circ\text{C})$	-20	A
Drain Current - Pulsed	I_{DM}	-60	A
Gate-Source Voltage	V_{GS}	± 20	V
Power Dissipation	$P_D(T_C=25^\circ\text{C})$	60	W
Junction and Storage Temperature Range	T_J, T_{STG}	-55 to 175	$^\circ\text{C}$
Thermal Resistance, Junction-to-Ambient	$R_{\theta JA}$	25	$^\circ\text{C/W}$

电性能参数 / Electrical Characteristics(Ta=25°C)

参数 Parameter	符号 Symbol	测试条件 Test Conditions	最小值 Min	典型值 Typ	最大值 Max	单位 Unit
Drain-Source Breakdown Voltage	BV_{DSS}	$V_{GS}=0V$ $I_D=-250\mu A$	-60			V
Zero Gate Voltage Drain Current	I_{DSS}	$V_{DS}=-48V$ $V_{GS}=0V$			-1.0	μA
Gate-Body Leakage Current Forward	I_{GSS}	$V_{GS}=\pm 20V$ $V_{DS}=0V$			± 100	nA
Gate Threshold Voltage	$V_{GS(th)}$	$V_{DS}=V_{GS}$ $I_D=-250\mu A$	-1.0	-1.8	-2.5	V
Static Drain-Source On-Resistance	$R_{DS(on)}$	$V_{GS}=-10V$ $I_D=-20A$		31	40	m Ω
		$V_{GS}=-4.5V$ $I_D=-20A$		42	55	m Ω
Forward Transconductance	g_{FS}	$V_{DS}=-5V$ $I_D=-20A$		5		S
Drain-Source Diode Forward Voltage	V_{SD}	$V_{GS}=0V$ $I_S=-1A$		-0.72	-1	V
Input Capacitance	C_{iss}	$V_{DS}=-30V$ $V_{GS}=0V$ $f=1.0MHz$		3060		pF
Output Capacitance	C_{oss}			300		pF
Reverse Transfer Capacitance	C_{rss}			205		pF
Turn-On Delay Time	$t_{d(on)}$	$V=-30V$ $V=-10V$ $R_{GEN}=3\Omega$ $I_D=1A$		14		ns
Turn-On Rise Time	t_r			20		ns
Turn-Off Delay Time	$t_{d(off)}$			49		ns
Turn-Off Fall Time	t_f			19		ns
Total Gate Charge	Q_g	$V_{DD}=-30V$ $I_D=-20A$ $V_{GS}=-10V$		48		nC
Gate-Source Charge	Q_{gs}			11		nC
Gate-Drain Charge	Q_{gd}			10		nC
Reverse Recovery Time	T_{rr}	$I_F=-20A$ $dI/dt=100A/\mu s$		40		nS
Reverse Recovery Charge	Q_{rr}			56		nC

电参数曲线图 / Electrical Characteristic Curve

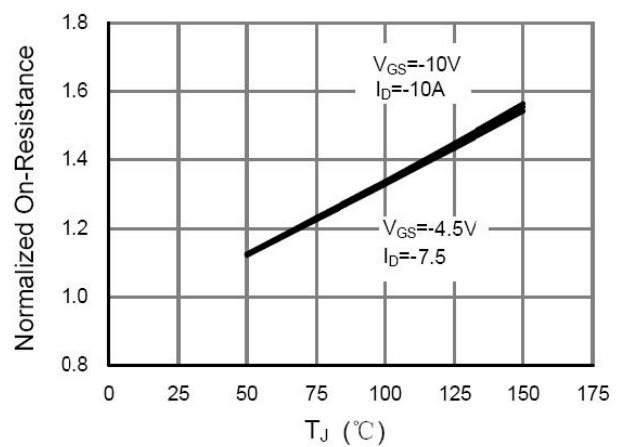
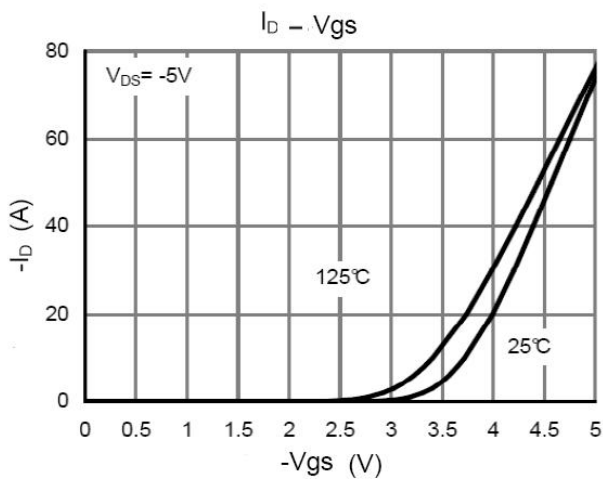
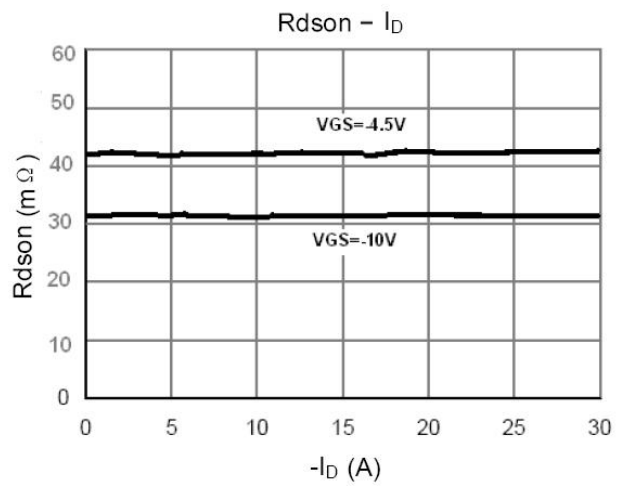
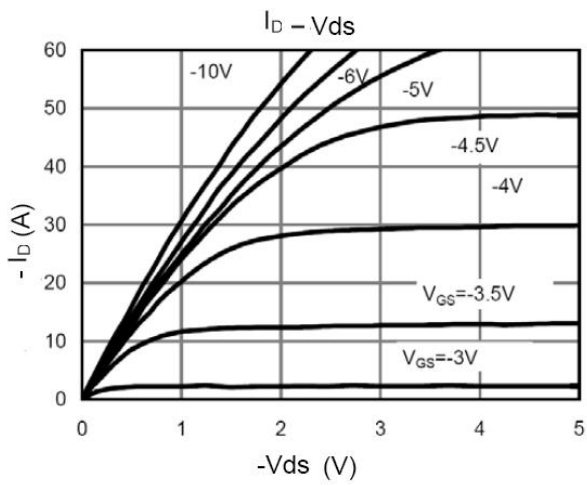
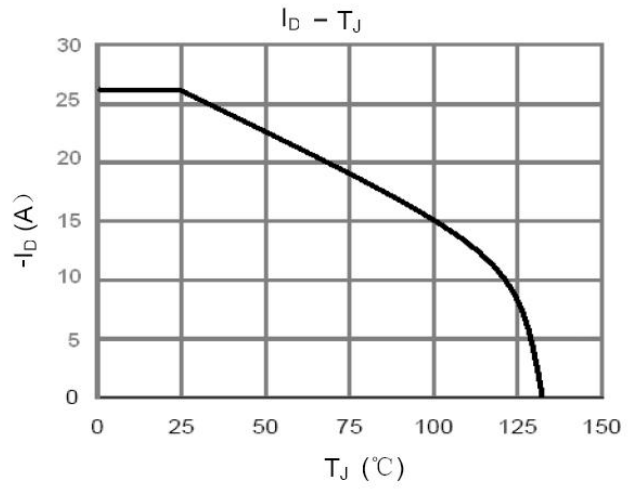
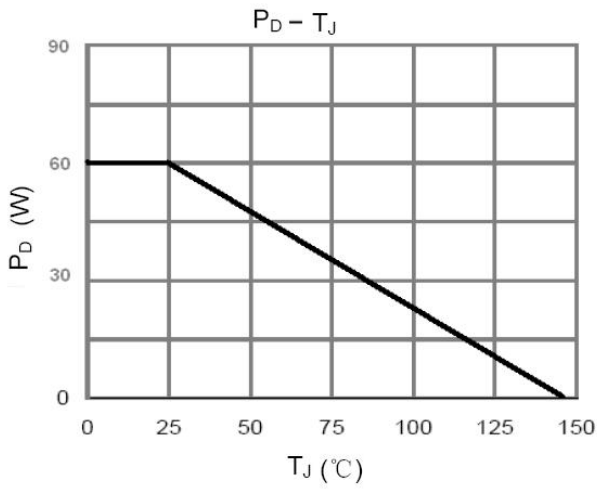

电参数曲线图 / Electrical Characteristic Curve

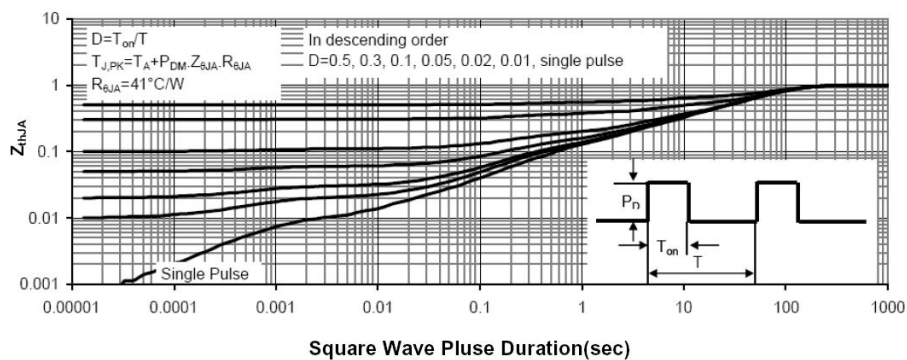
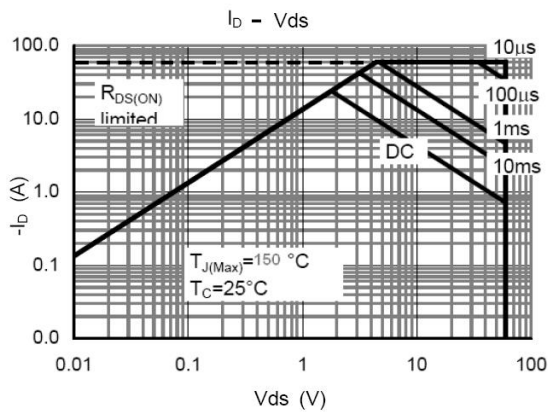
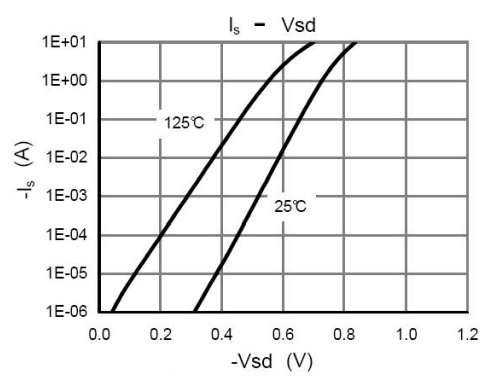
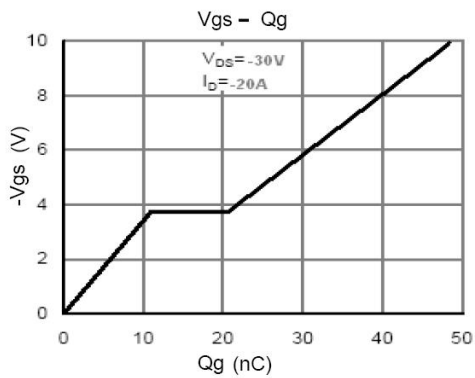
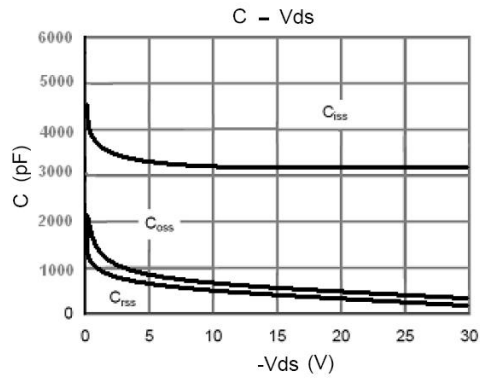
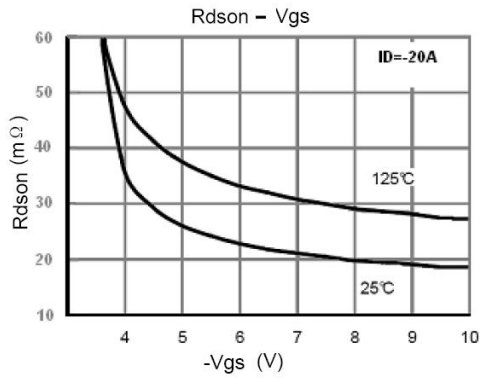

典型电性和热特性 / Typical electrical and thermal properties

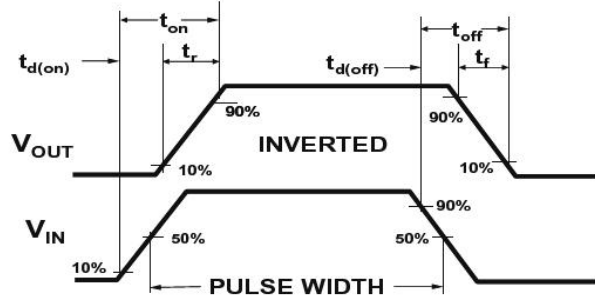
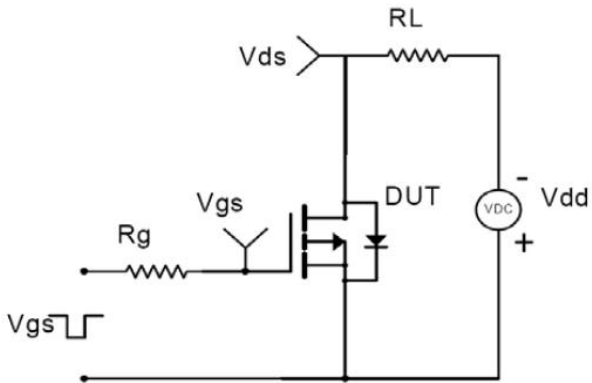

外形尺寸图 / Package Dimensions

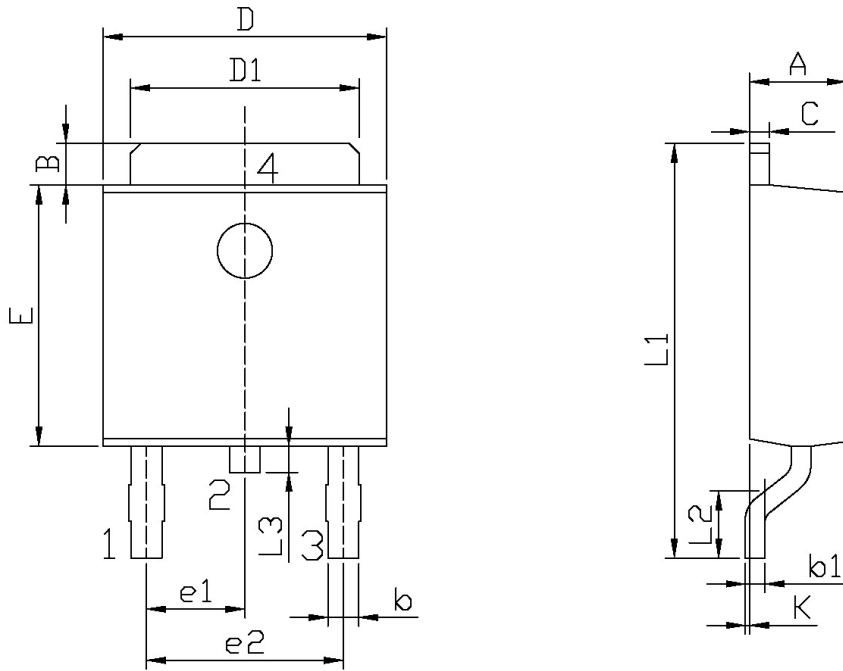

单位: mm

Symbol	Dimensions In Millimeters		Symbol	Dimensions In Millimeters	
	Min	Max		Min	Max
A	2.20	2.40	E	5.95	6.25
B	0.95	1.25	e1	2.24	2.34
b	0.50	0.70	e2	4.43	4.73
b1	0.45	0.55	L1	9.45	9.95
C	0.45	0.55	L2	1.25	1.75
D	6.45	6.75	L3	0.60	0.90
D1	5.10	5.50	K	0.00	0.10

TO-252

印章说明 / Marking Instructions

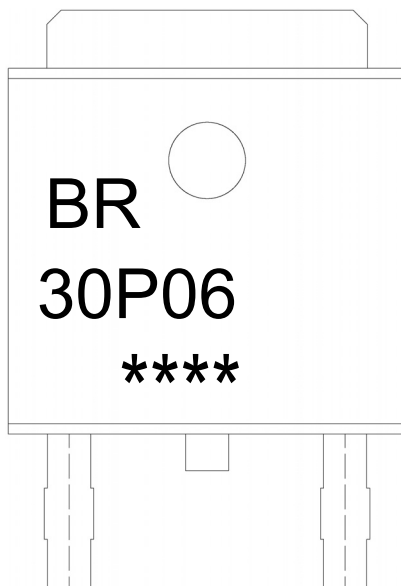

说明：

BR： 为公司代码

30P06： 为型号代码

****： 为生产批号代码，随生产批号变化。

Note:

BR: Company Code

30P06: Product Type.

****: Lot No. Code, code change with Lot No.

回流焊温度曲线图(无铅) / Temperature Profile for IR Reflow Soldering(Pb-Free)

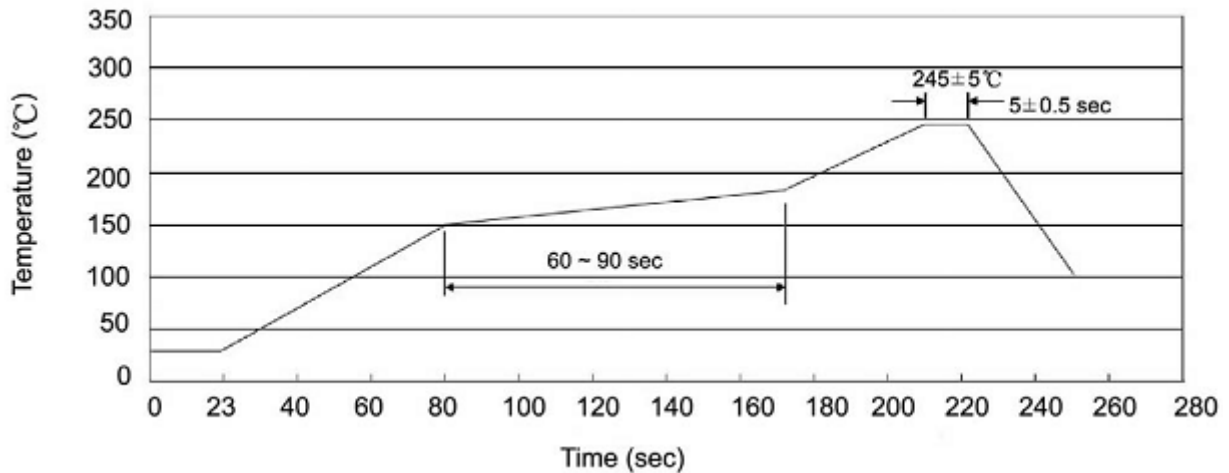

说明：

- 1、预热温度 25~150°C，时间 60~90sec;
- 2、峰值温度 245±5°C，时间持续为 5±0.5sec;
- 3、焊接制程冷却速度为 2~10°C/sec.

Note:

- 1.Preheating:25~150°C, Time:60~90sec.
- 2.Peak Temp.:245±5°C, Duration:5±0.5sec.
3. Cooling Speed: 2~10°C/sec.

耐焊接热试验条件 / Resistance to Soldering Heat Test Conditions

温度：260±5°C 时间：10±1 sec. Temp.:260±5°C Time:10±1 sec

包装规格 / Packaging SPEC.

卷盘包装 / REEL

Package Type 封装形式	Units 包装数量					Dimension 包装尺寸 (unit: mm ³)		
	Units/Reel 只/卷盘	Reels/Inner Box 卷盘/盒	Units/Inner Box 只/盒	Inner Boxes/Outer Box 盒/箱	Units/Outer Box 只/箱	Reel	Inner Box 盒	Outer Box 箱
TO-252	2,500	2	5,000	5	25,000	13" ×16	360×360×50	385×257×392

套管包装 / TUBE

Package Type 封装形式	Units 包装数量					Dimension 包装尺寸 (unit: mm ³)		
	Units/Tube 只/套管	Tubes/Inner Box 套管/盒	Units/Inner Box 只/盒	Inner Boxes/Outer Box 盒/箱	Units/Outer Box 只/箱	Tube 套管	Inner Box 盒	Outer Box 箱
TO-251/252	75	48	3,600	5	18,000	526×20.5×5.25	555×164×50	575×290×180

使用说明 / Notices