

BRCS90P03RA

Rev.B .Jul.-2018

描述 / Descriptions

TO-220 塑封封装 P 沟道 MOS 场效应管。P-CHANNEL MOSFET in a TO-220 Plastic Package.

特征 / Features

低栅电荷，低反馈电容，开关速度快。
Low gate charge, low crss, fast switching.

用途 / Applications

用于高功率 DC/DC 转换盒功率开关。
These devices are well suited for high efficiency switching DC/DC converters and switch mode power supplies.

内部等效电路 / Equivalent Circuit

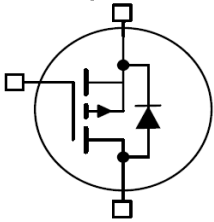

引脚排列 / Pinning

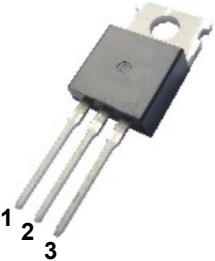

PIN 1 : G PIN 2 : D PIN 3 : S

放大及印章代码 / h_{FE} Classifications & Marking

见印章说明。See Marking Instructions.

极限参数 / Absolute Maximum Ratings(Ta=25°C)

参数 Parameter	符号 Symbol	数值 Rating	单位 Unit
Drain-Source Voltage	V_{DS}	-30	V
Drain Current	I_D	-90	A
Drain Current - Pulsed	I_{DM}	-360	A
Gate-Source Voltage	V_{GS}	± 20	V
Single Pulsed Avalanche Energy	E_{AS}	370	mJ
Avalanche current, single pulse	I_{AS}	-90	A
Power Dissipation	$P_{tot}(T_c=25^\circ C)$	137	W
Junction and Storage Temperature Range	T_J, T_{STG}	-55 to 150	$^\circ C$

电性能参数 / Electrical Characteristics(Ta=25°C)

参数 Parameter	符号 Symbol	测试条件 Test Conditions	最小值 Min	典型值 Typ	最大值 Max	单位 Unit
Drain-Source Breakdown Voltage	BV_{DSS}	$V_{GS}=0V$ $I_D=-1mA$	-30			V
Zero Gate Voltage Drain Current	I_{DSS}	$V_{DS}=-30V$ $V_{GS}=0V$ $T_a=25^\circ C$			-1.0	μA
		$V_{DS}=-30V$ $V_{GS}=0V$ $T_a=125^\circ C$			-200	μA
Gate-Body Leakage Current, Forward	I_{GSS}	$V_{GS}=\pm 20V$ $V_{DS}=0V$			± 100	nA
Gate Threshold Voltage	$V_{GS(th)}$	$V_{DS}=V_{GS}$ $I_D=-250\mu A$	-1.2		-2.2	V
Static Drain-Source On-Resistance	$R_{DS(on)}$	$V_{GS}=-10V$ $I_D=-20A$		4.4	6	m Ω
Drain-Source Diode Forward Voltage	V_{SD}	$V_{GS}=0V$ $I_F=-24A$			-1.2	V
Input Capacitance	C_{iss}	$V_{DS}=-25V$ $V_{GS}=0V$ $f=1.0MHz$		6600		pF
Output Capacitance	C_{oss}			675		
Reverse Transfer Capacitance	C_{rss}			518		
Turn-On Delay Time	$t_{d(on)}$		$V_{DD}=-15V$ $I_D=-90A$ $V_{GS}=-10V$ $R_{GEN}=3.5\Omega$		35	
Turn-On Rise Time	t_r			10		
Turn-Off Delay Time	$t_{d(off)}$			70		
Turn-Off Fall Time	t_f			20		

电性能参数 / Electrical Characteristics(Ta=25°C)

参数 Parameter	符号 Symbol	测试条件 Test Conditions	最小值 Min	典型值 Typ	最大值 Max	单位 Unit
Gate to source charge	Q_{gs}	$V_{DD}=-24V, I_D=-90A,$ $V_{GS}=0 \text{ to } -10V$		42	55	nC
Gate to drain charge	Q_{gd}			10	20	nC
Gate charge total	Q_g			100	130	nC
Gate plateau voltage	$V_{plateau}$			-5.3		V
Diode continuous forward current ²⁾	I_S	$T_C=25^\circ C$			-90	A
Diode pulse current ²⁾	$I_{S,pulse}$				-360	A
Reverse recovery time ²⁾	t_{rr}	$V_R=-15V, I_F=-50A,$ $di_F/dt =-100A/\mu s$		50		nS
Reverse recovery charge ²⁾	Q_{rr}			70		nC
Thermal resistance, junction - case	$R_{\theta JA}$				1.1	K/W
SMD version, device on PCB	$R_{\theta JC}$	minimal footprint			62	
		6 cm ² cooling area ³⁾			40	

1) Current is limited by bondwire; with an $R_{\theta JC} = 1.1K/W$ the chip is able to carry -143A at 25°C.

2) Defined by design. Not subject to production test.

3) Device on 40 mm x 40 mm x 1.5 mm epoxy PCB FR4 with 6 cm² (one layer, 70 μm thick) copper area for drain connection. PCB is vertical in still air.

电参数曲线图 / Electrical Characteristic Curve

1 Power dissipation

$$P_{tot} = f(T_c); V_{GS} \leq -6V$$

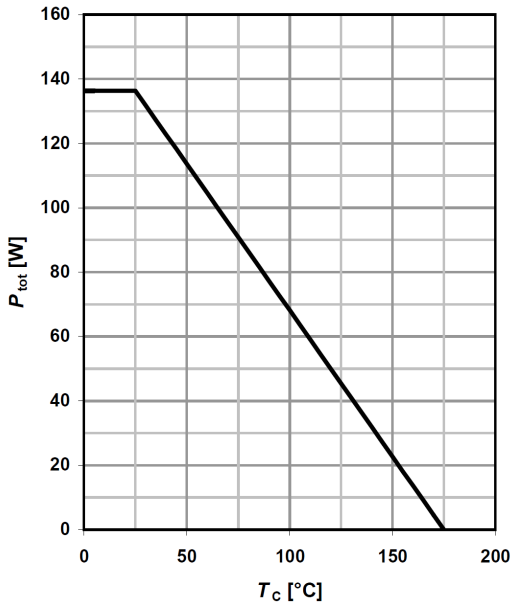

2 Drain current

$$I_D = f(T_c); V_{GS} \leq -6V$$

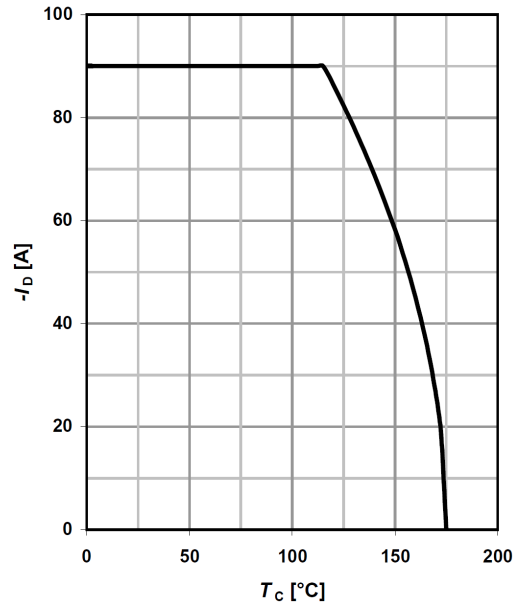

3 Safe operating area

$$I_D = f(V_{DS}); T_c = 25^\circ C; D = 0$$

parameter: t_p

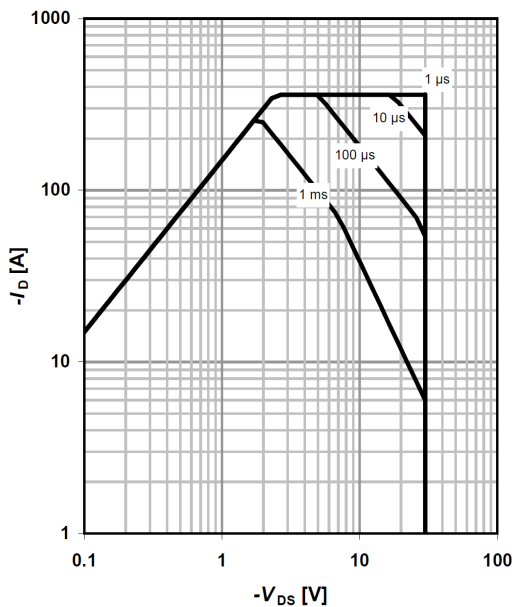

4 Max. transient thermal impedance

$$Z_{thJC} = f(t_p)$$

parameter: $D = t_p/T$

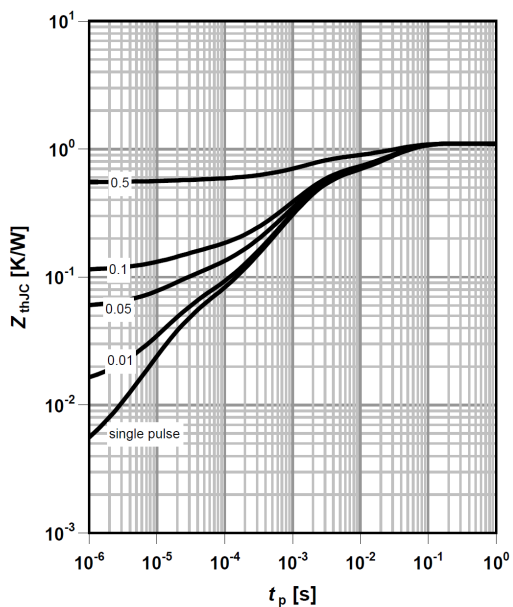

电参数曲线图 / Electrical Characteristic Curve

5 Typ. output characteristics

$I_D = f(V_{DS}); T_j = 25\text{ }^\circ\text{C}$

parameter: V_{GS}

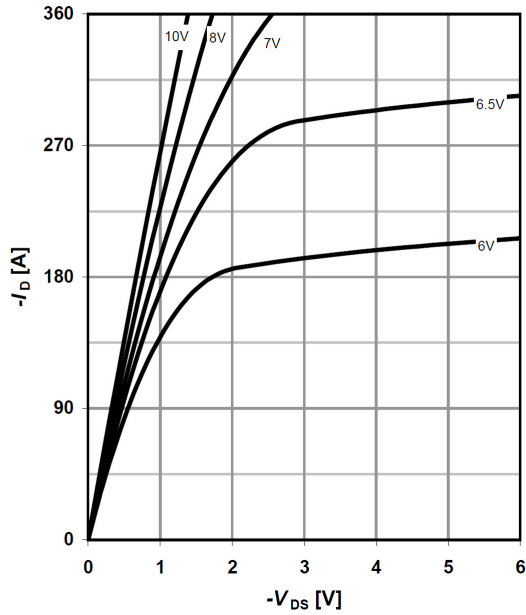

6 Typ. drain-source on-state resistance

$R_{DS(on)} = f(I_D); T_j = 25\text{ }^\circ\text{C}$

parameter: V_{GS}

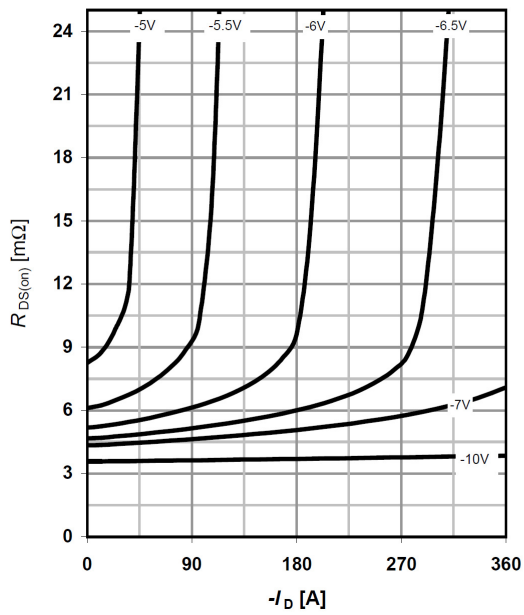

7 Typ. transfer characteristics

$I_D = f(V_{GS}); V_{DS} = -6V$

parameter: T_j

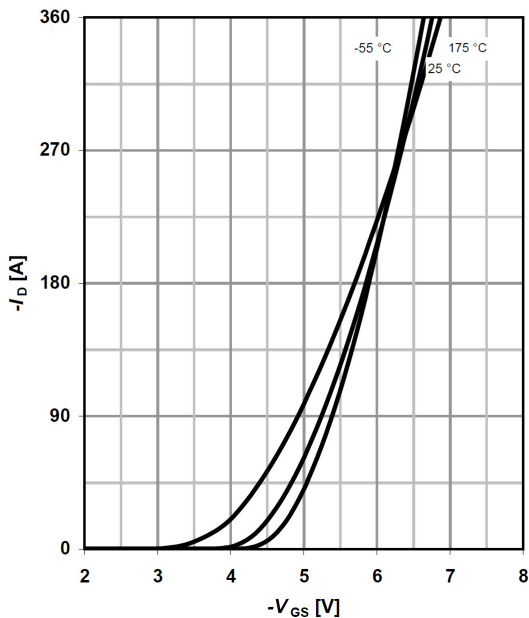

8 Typ. drain-source on-state resistance

$R_{DS(on)} = f(T_j); I_D = -90\text{ A}; V_{GS} = -10\text{ V}$

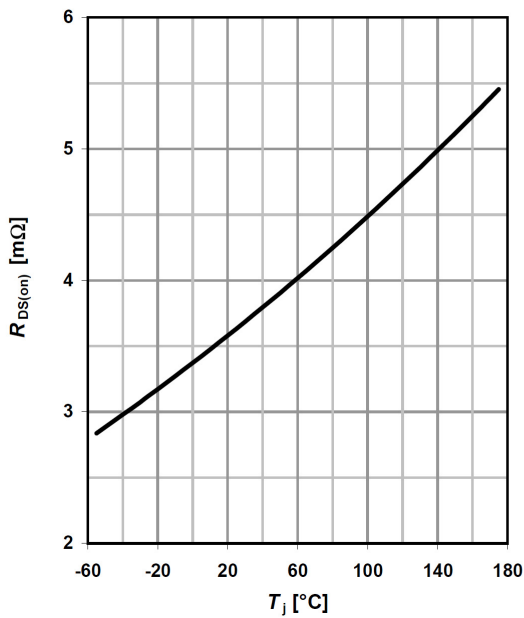

电参数曲线图 / Electrical Characteristic Curve

9 Typ. gate threshold voltage

$V_{GS(th)} = f(T_j); V_{GS} = V_{DS}$

parameter: $-I_D$

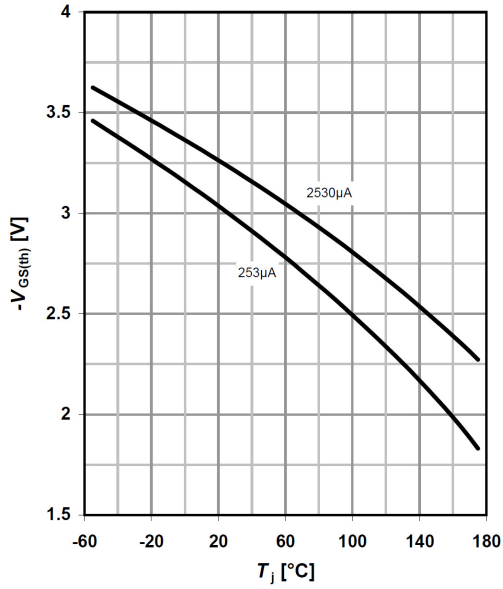

10 Typ. capacitances

$C = f(V_{DS}); V_{GS} = 0 V; f = 1 MHz$

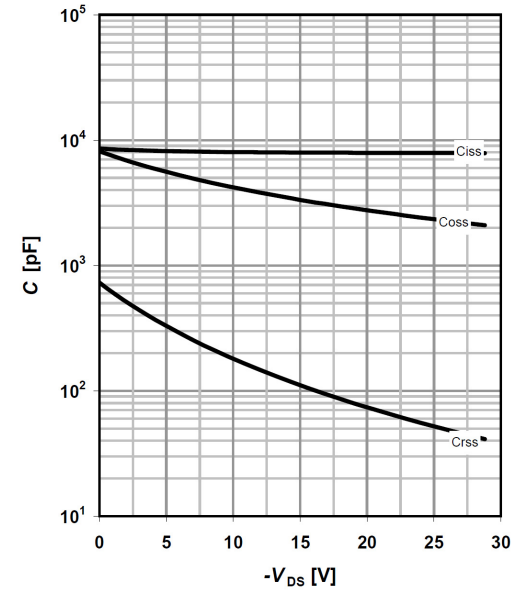

11 Typical forward diode characteristics

$I_F = f(V_{SD})$

parameter: T_j

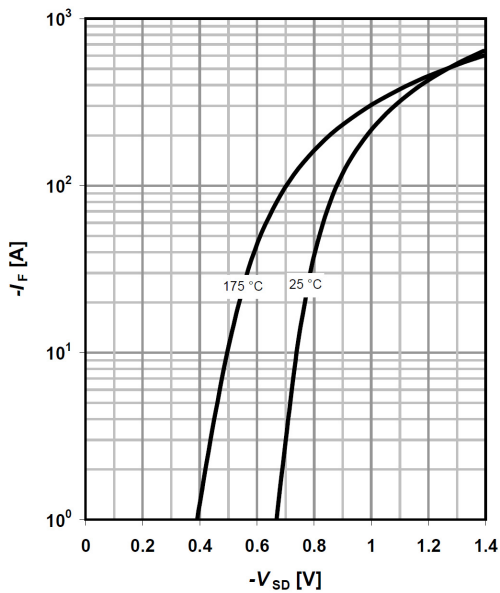

12 Avalanche characteristics

$I_{AS} = f(t_{AV})$

parameter: $T_{j(start)}$

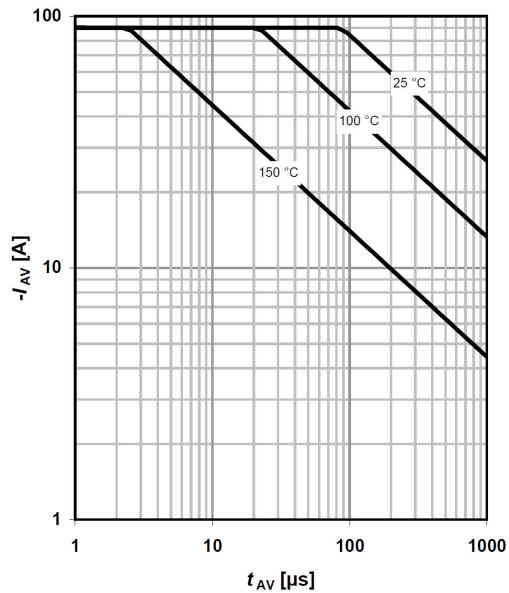

电参数曲线图 / Electrical Characteristic Curve

13 Avalanche energy

$E_{AS} = f(T_j)$

parameter: I_D

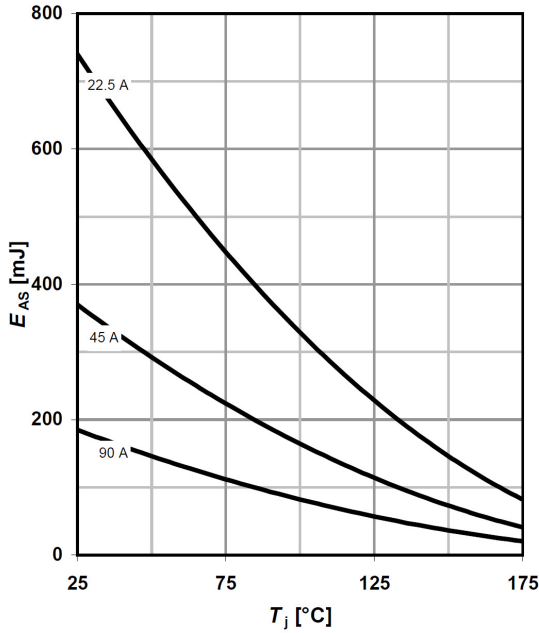

14 Drain-source breakdown voltage

$V_{BR(DSS)} = f(T_j); I_D = -1 \text{ mA}$

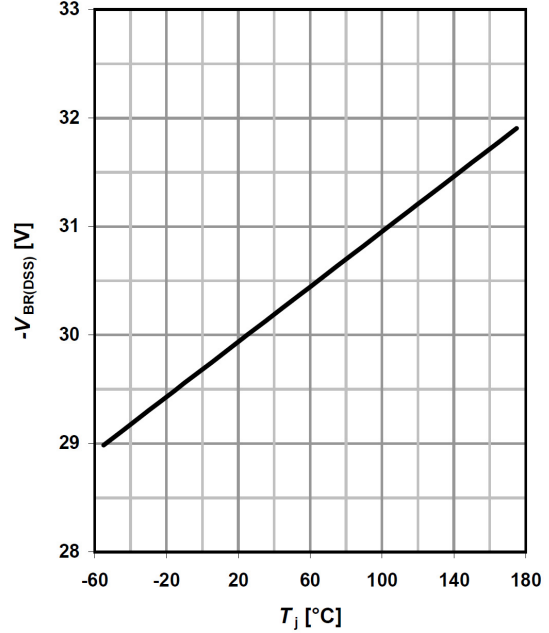

15 Typ. gate charge

$V_{GS} = f(Q_{gate}); I_D = -90 \text{ A pulsed}$

parameter: V_{DD}

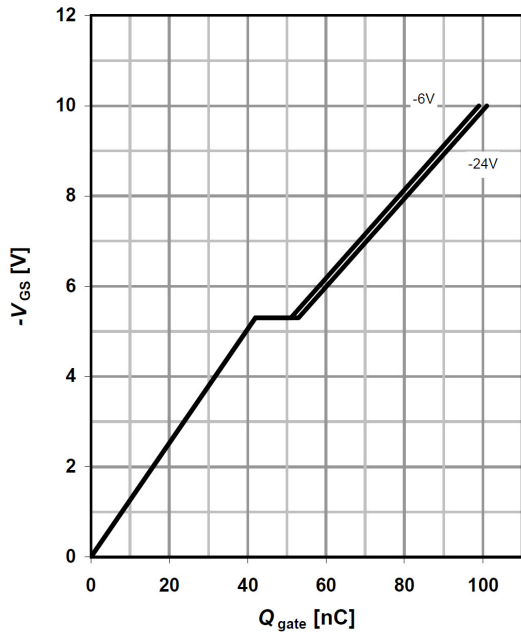

16 Gate charge waveforms

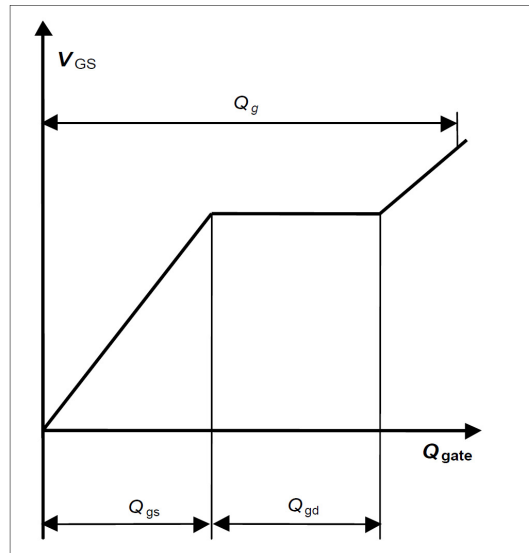

外形尺寸图 / Package Dimensions

T□-220

单位: mm

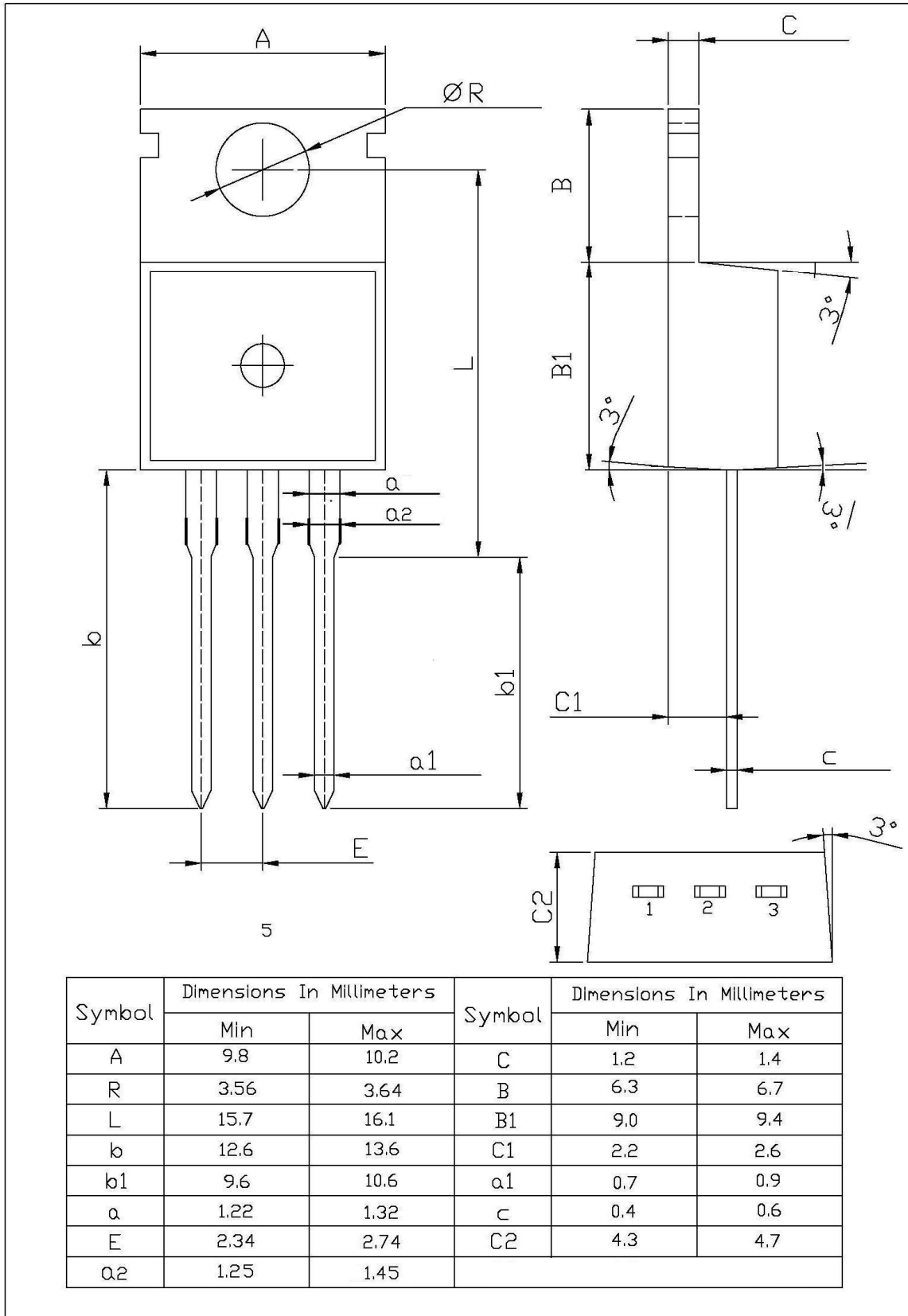

印章说明 / Marking Instructions

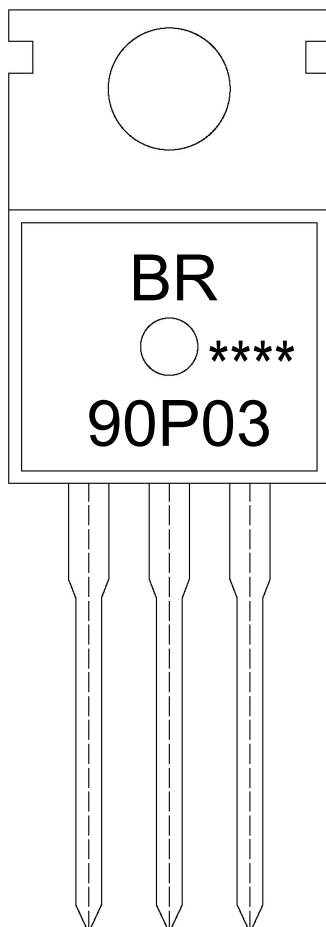

说明：

BR： 为公司代码

90P03： 为型号代码

****： 为生产批号代码，随生产批号变化。

Note:

BR: Company Code

90P03: Product Type.

****: Lot No. Code, code change with Lot No.

波峰焊温度曲线图(无铅) / Temperature Profile for Dip Soldering(Pb-Free)

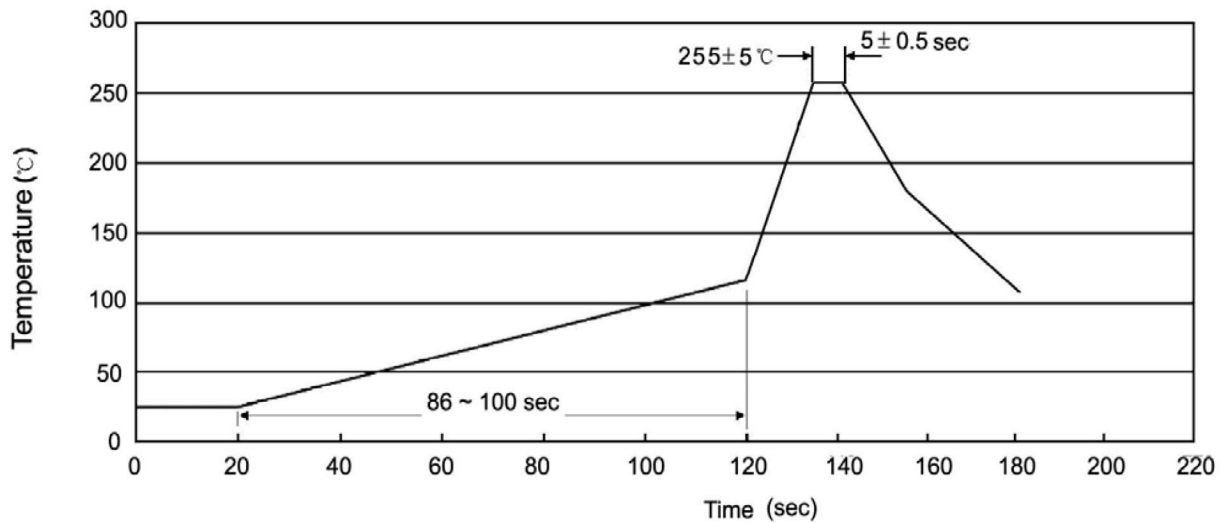

说明：

- 1、预热温度 25 ~ 150°C，时间 60 ~ 90sec；
- 2、峰值温度 255±5°C，时间持续为 5±0.5sec；
- 3、焊接制程冷却速度为 2 ~ 10°C/sec.

Note:

- 1.Preheating:25~150°C, Time:60~90sec.
- 2.Peak Temp.:255±5°C, Duration:5±0.5sec.
3. Cooling Speed: 2~10°C/sec.

耐焊接热试验条件 / Resistance to Soldering Heat Test Conditions

温度：270±5°C

时间：10±1 sec.

Temp.:270±5°C

Time:10±1 sec

包装规格 / Packaging SPEC.

散件包装 / BULK

Package Type 封装形式	Units 包装数量					Dimension 包装尺寸 (unit: mm ³)		
	Units/Bag 只/袋	Bags/Inner Box 袋/盒	Units/Inner Box 只/盒	Inner Boxes/Outer Box 盒/箱	Units/Outer Box 只/箱	Bag 袋	Inner Box 盒	Outer Box 箱
TO-220/F	200	10	2,000	5	10,000	135×190	237×172×102	560×245×195

套管包装 / TUBE

Package Type 封装形式	Units 包装数量					Dimension 包装尺寸 (unit: mm ³)		
	Units/Tube 只/套管	Tubes/Inner Box 套管/盒	Units/Inner Box 只/盒	Inner Boxes/Outer Box 盒/箱	Units/Outer Box 只/箱	Tube 套管	Inner Box 盒	Outer Box 箱
TO-220/F	50	20	1,000	5	5,000	532×31.4×5.5	555×164×50	575×290×180

使用说明 / Notices