



N 沟道增强型场效应晶体管

N-CHANNEL MOSFET

FHP130N10A

主要参数 MAIN CHARACTERISTICS

ID	130 A
VDSS	100 V
Rdson-typ (@Vgs=10V)	7mΩ
Qg-typ	110nC

产品特性 FEATURES

低栅极电荷	Low gate charge
低 Crss (典型值 330pF)	Low Crss (typical 330pF)
开关速度快	Fast switching
100%经过雪崩测试	100% avalanche tested
高抗 dv/dt 能力	Improved dv/dt capability
RoHS 产品	RoHS product

用途 APPLICATIONS

逆变电源	Power management for inverter systems
功率开关	switch mode power supplies
直流电机控制	DC motor control

封装形式 Package

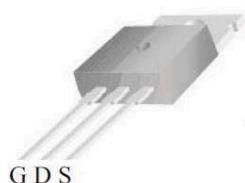

TO-220
FHP series

等效电路 Equivalent Circuit

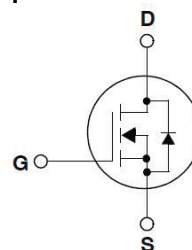

绝对最大额定值 ABSOLUTE RATINGS (Tc=25°C)

项目 Parameter	符号 Symbol	数值 Value	单位 Unit
		FHP130N10A	
最高漏极-源极直流电压 Drain-Source Voltage	V _{DS}	100	V
连续漏极电流* Drain Current -continuous *	I _D (T _C =25°C)	130	A
	I _D (T _C =100°C)	90	A
最大脉冲漏极电流 (注 1) Drain Current - pulse (note 1)	I _{DM}	400	A
最高栅源电压 Gate-Source Voltage	V _{GS}	±25	V
单脉冲雪崩能量 (注 2) Single Pulsed Avalanche Energy (note 2)	E _{AS}	384	mJ
雪崩电流 (注 1) Avalanche Current (note 1)	I _{AR}	20	A
重复雪崩能量 (注 1) Repetitive Avalanche Current (note 1)	E _{AR}	20	mJ
二极管反向恢复最大电压变化速率 (注 3) Peak Diode Recovery dv/dt (note 3)	dv/dt	5	V/ns
耗散功率 Power Dissipation	P _D (T _C =25°C)	230	W
	-Derate above 25°C	1.3	W/°C
最高结温及存储温度 Operating and Storage Temperature Range	T _J , T _{STG}	-55~+175	°C
引线最高焊接温度 Maximum Lead Temperature for Soldering Purposes	T _L	300	°C

*漏极电流由最高结温限制

*Drain current limited by maximum junction temperature

电特性 ELECTRICAL CHARACTERISTICS

项目 Parameter	符号 Symbol	测试条件 Tests conditions	最小 Min	典型 Typ	最大 Max	单位 Units
关态特性 Off –Characteristics						
漏—源击穿电压 Drain-Source Voltage	BV _{DSS}	I _D =250μA, V _{GS} =0V	100	-	-	V
击穿电压温度特性 Breakdown Voltage Temperature Coefficient	ΔBV _{DSS} /ΔT _J	I _D =250μA, referenced to 25°C	-	0.01	-	V/°C
零栅压下漏极漏电流 Zero Gate Voltage Drain Current	I _{DSS}	V _{DS} =100V, V _{GS} =0V, T _C =25°C	-	-	1	μA
		V _{DS} =80V, T _C =125°C	-	-	10	μA
栅极体漏电流 Gate-body leakage current	I _{GSS (F/R)}	V _{DS} =0V, V _{GS} =±25V	-	-	±100	nA
通态特性 On-Characteristics						
阈值电压 Gate Threshold Voltage	V _{GS(th)}	V _{DS} = V _{GS} , I _D =250μA	2.0	3.0	4.0	V
静态导通电阻 Static Drain-Source On-Resistance	R _{DS(ON)}	V _{GS} =10V , I _D =40A	-	7	7.5	mΩ
正向跨导 Forward Transconductance	g _{fs}	V _{DS} = 20V, I _D =40A (note 4)	-	80	-	S
动态特性 Dynamic Characteristics						
栅电阻 Gate Resistance	R _g	f=1.0MHz, V _{DS} OPEN	-	1.7	-	Ω
输入电容 Input capacitance	C _{iss}	V _{DS} =25V, V _{GS} =0V, f=1.0MHz	-	4600	-	pF
输出电容 Output capacitance	C _{oss}		-	520	-	
反向传输电容 Reverse transfer capacitance	C _{rss}		-	330	-	
开关特性 Switching Characteristics						
延迟时间 Turn-On delay time	t _{d(on)}	V _{DS} =50V, I _D =30A, R _G =6Ω V _{GS} =10V (note 4, 5)	-	65	-	ns
上升时间 Turn-On rise time	t _r		-	70	-	ns
延迟时间 Turn-Off delay time	t _{d(off)}		-	190	-	ns
下降时间 Turn-Off Fall time	t _f		-	50	-	ns
栅极电荷总量 Total Gate Charge	Q _g	V _{DS} =80V , I _D =30A , V _{GS} =10V (note 4, 5)	-	110	-	nC
栅—源电荷 Gate-Source charge	Q _{gs}		-	24	-	nC
栅—漏电荷 Gate-Drain charge	Q _{gd}		-	44	-	nC
漏—源二极管特性及最大额定值 Drain-Source Diode Characteristics and Maximum Ratings						
正向最大连续电流 Maximum Continuous Drain -Source Diode Forward Current		I _S	-	-	130	A
正向最大脉冲电流 Maximum Pulsed Drain-Source Diode Forward Current		I _{SM}	-	-	400	A
正向压降 Drain-Source Diode Forward Voltage	V _{SD}	V _{GS} =0V, I _S =30A	-	0.82	1.3	V
反向恢复时间 Reverse recovery time	t _{rr}	V _{GS} =0V, I _S =30A ,dI _F /dt=100A/μs (note 4)	-	55	-	ns
反向恢复电荷 Reverse recovery charge	Q _{rr}		-	90	-	nC

热特性 THERMAL CHARACTERISTIC

项目 Parameter	符号 Symbol	最大值 Max	单位 Unit
结到管壳的热阻 Thermal Resistance, Junction to Case	Rth(j-c)	0.63	°C/W
结到环境的热阻 Thermal Resistance, Junction to Ambient	Rth(j-A)	62.5	°C/W

注释:

- 1: 脉冲宽度由最高结温限制
- 2: L=1mH, I_{AS}=20A, V_{DD}=48V, R_G=25 Ω, 起始结温 T_J=25°C
- 3: I_{SD} ≤ 130A, di/dt ≤ 200A/μs, V_{DD} ≤ B_VD_{SS}, 起始结温 T_J=25°C
- 4: 脉冲测试: 脉冲宽度 ≤ 300μs, 占空比 ≤ 2%
- 5: 基本与工作温度无关

Notes:

- 1: Pulse width limited by maximum junction temperature
- 2: L=1mH, I_{AS}=20A, V_{DD}=48V, R_G=25 Ω, Starting T_J=25°C
- 3: I_{SD} ≤ 130A, di/dt ≤ 200A/μs, V_{DD} ≤ B_VD_{SS}, Starting T_J=25°C
- 4: Pulse Test: Pulse Width ≤ 300μs, Duty Cycle ≤ 2%
- 5: Essentially independent of operating temperatur

Typical Characteristics

典型特性曲线

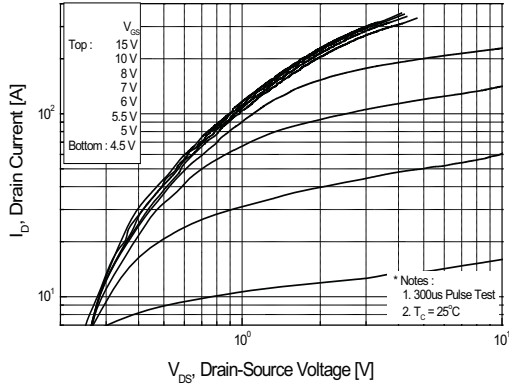

Figure 1. On Region Characteristics

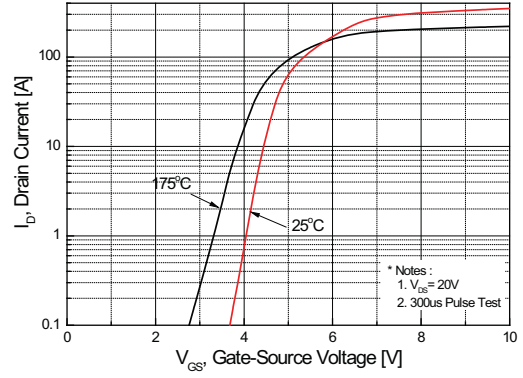

Figure 2. Transfer Characteristics

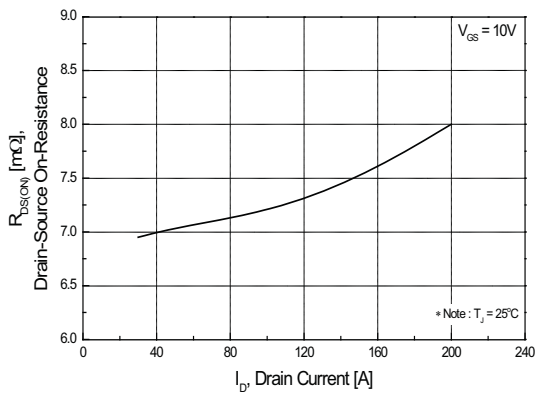

Figure 3. On Resistance Variation vs Drain Current and Gate Voltage

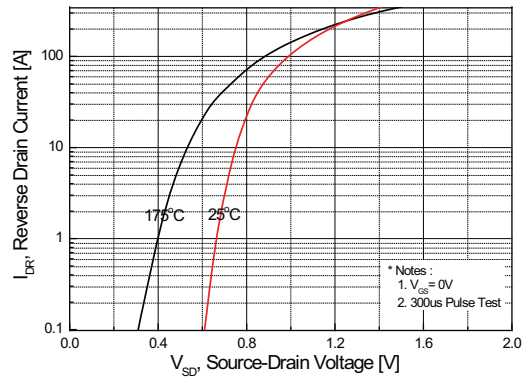

Figure 4. Body Diode Forward Voltage Variation with Source Current and Temperature

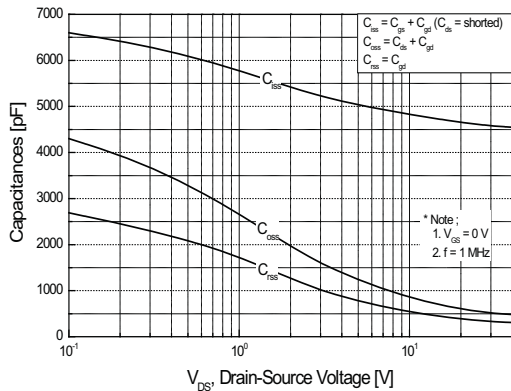

Figure 5. Capacitance Characteristics

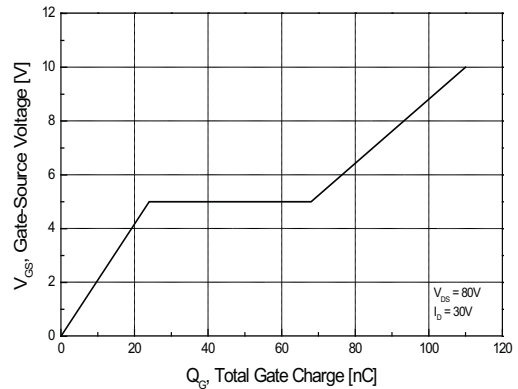

Figure 6. Gate Charge Characteristics

Typical Characteristics (continued)

典型特性曲线 (续)

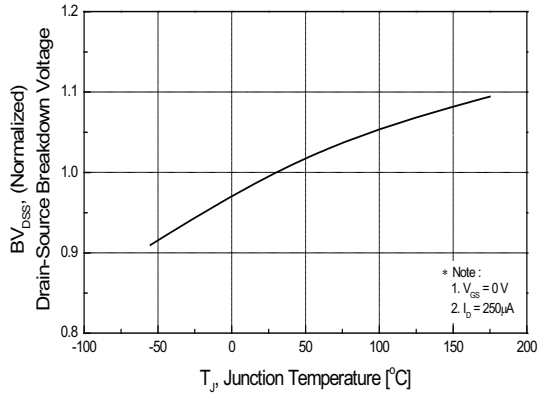

Figure 7. Breakdown Voltage Variation vs Temperature

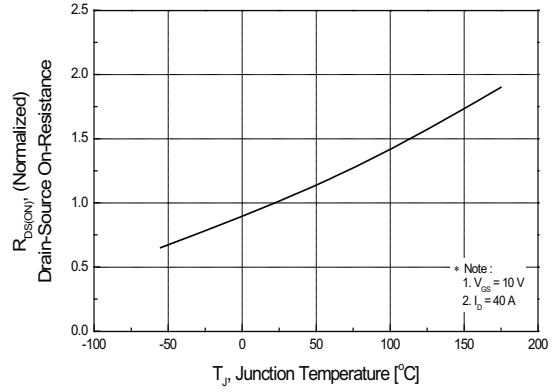

Figure 8. On-Resistance Variation vs Temperature

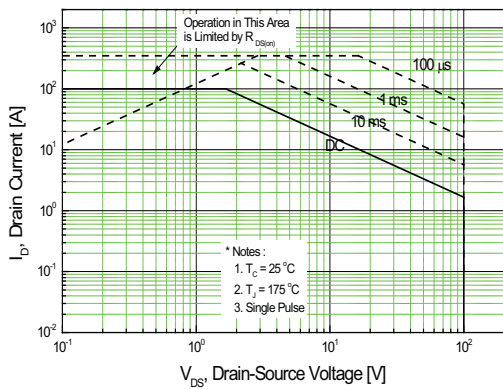

Figure 9. Maximum Safe Operating Area

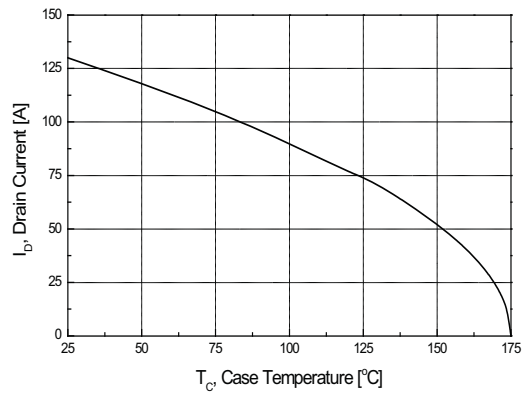

Figure 10. Maximum Drain Current vs Case Temperature

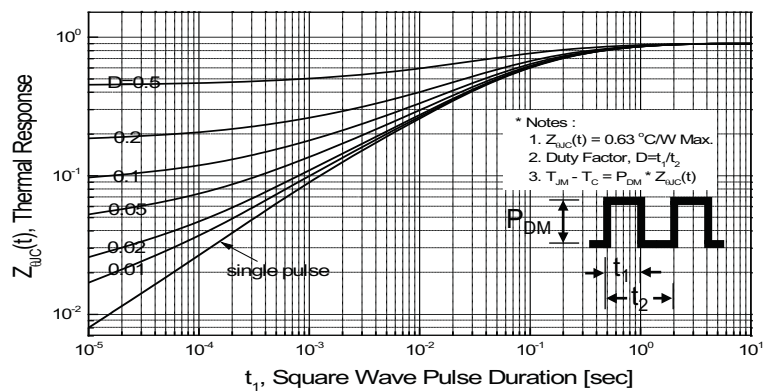

Figure 11. Transient Thermal Response Curve

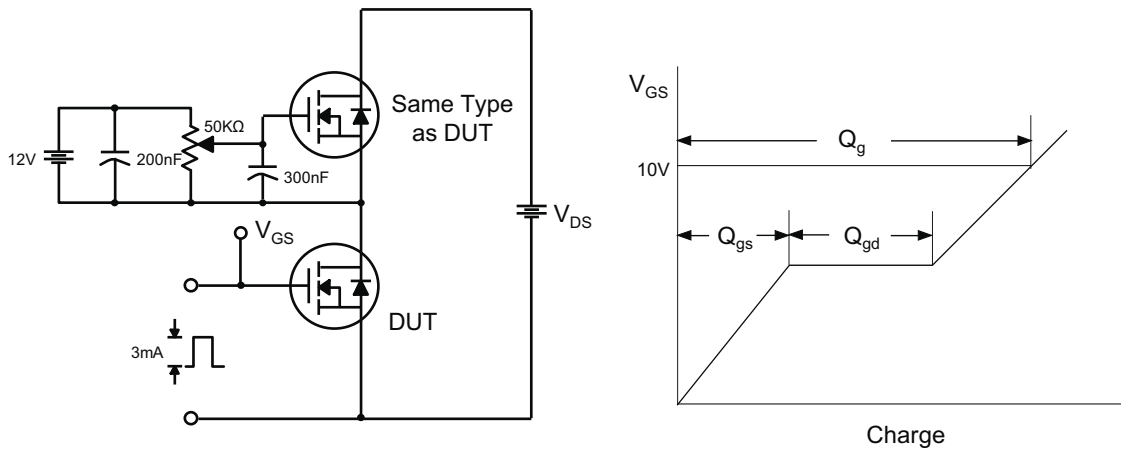

Fig 12. Gate Charge Test Circuit & Waveform

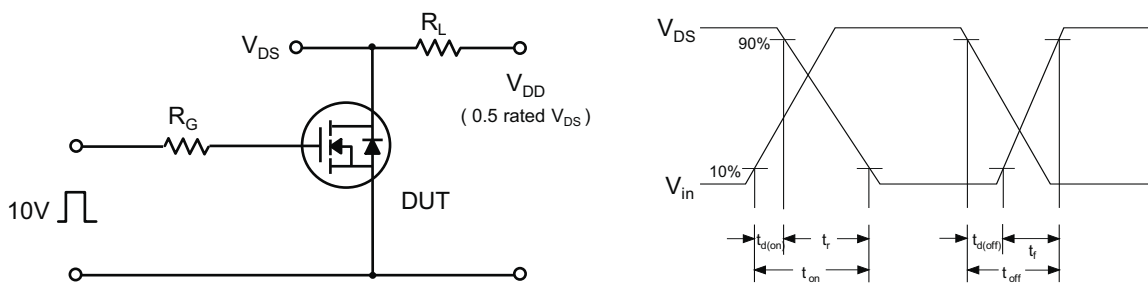

Fig 13. Resistive Switching Test Circuit & Waveforms

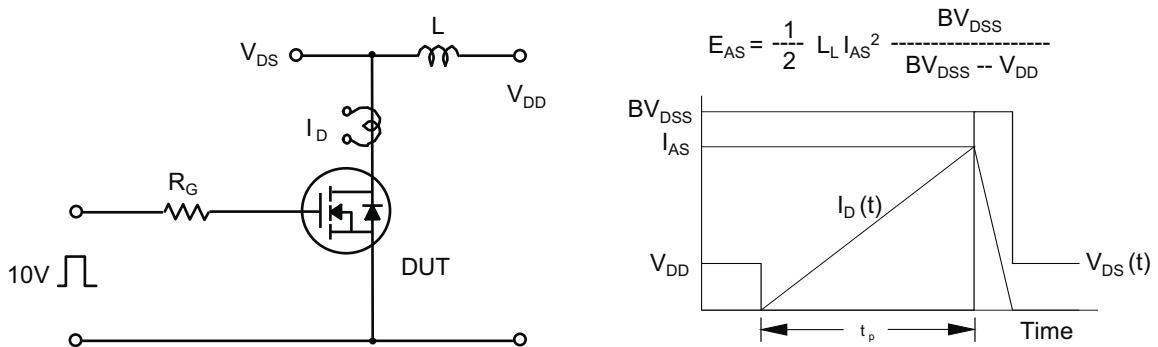

Fig 14. Unclamped Inductive Switching Test Circuit & Waveforms

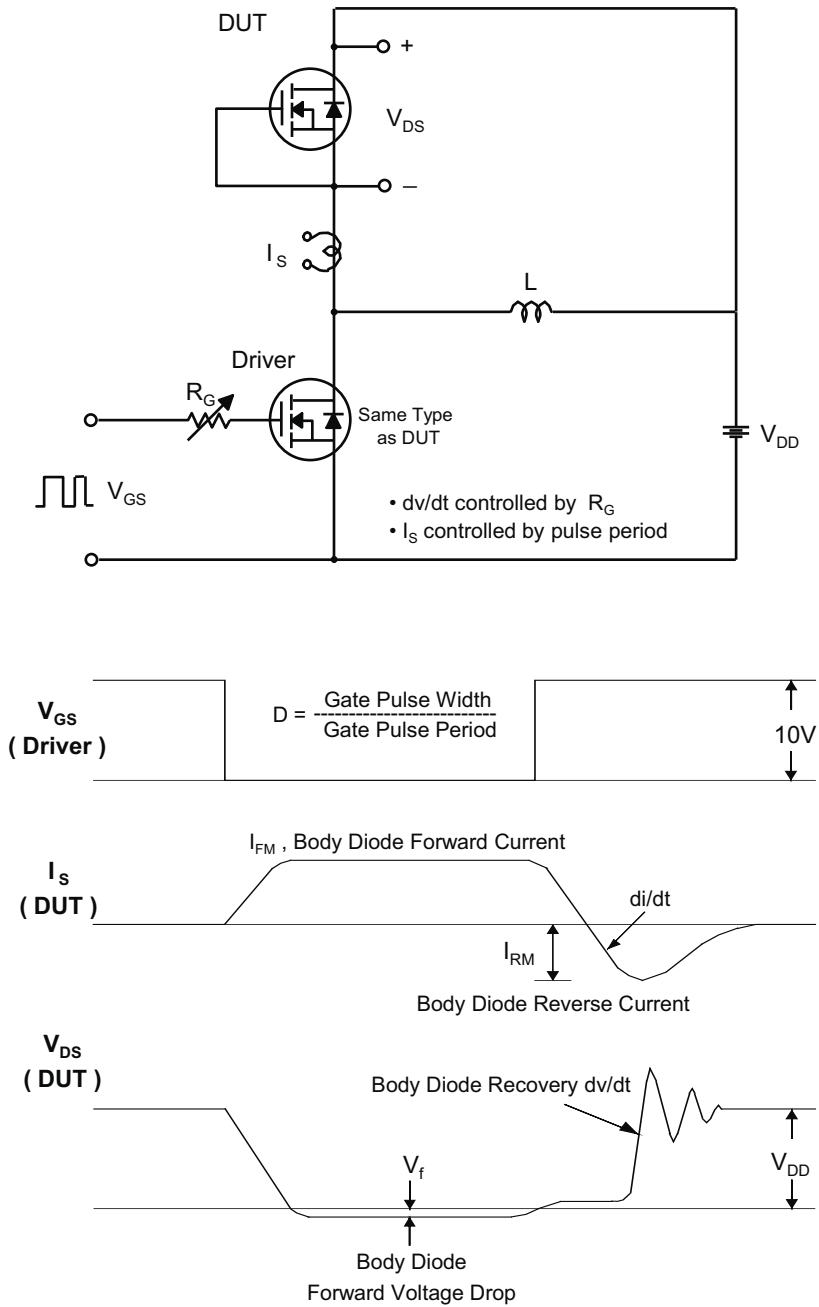
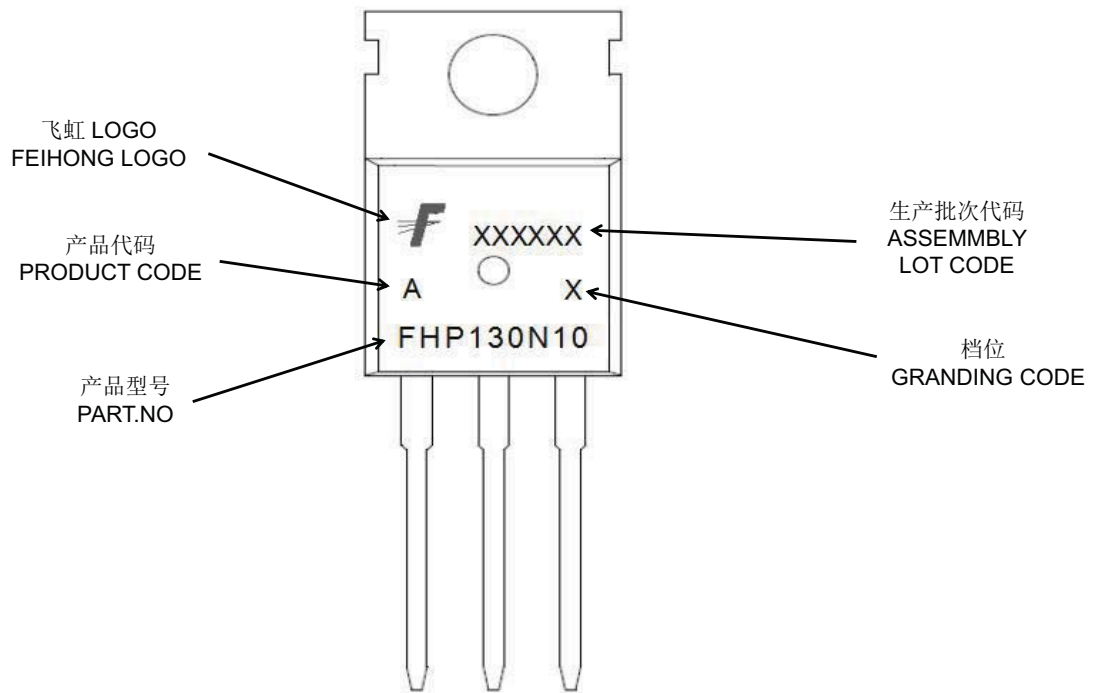

Fig 15. Peak Diode Recovery dv/dt Test Circuit & Waveforms

印记 Marking:



外形尺寸:

Package Dimension:

TO-220

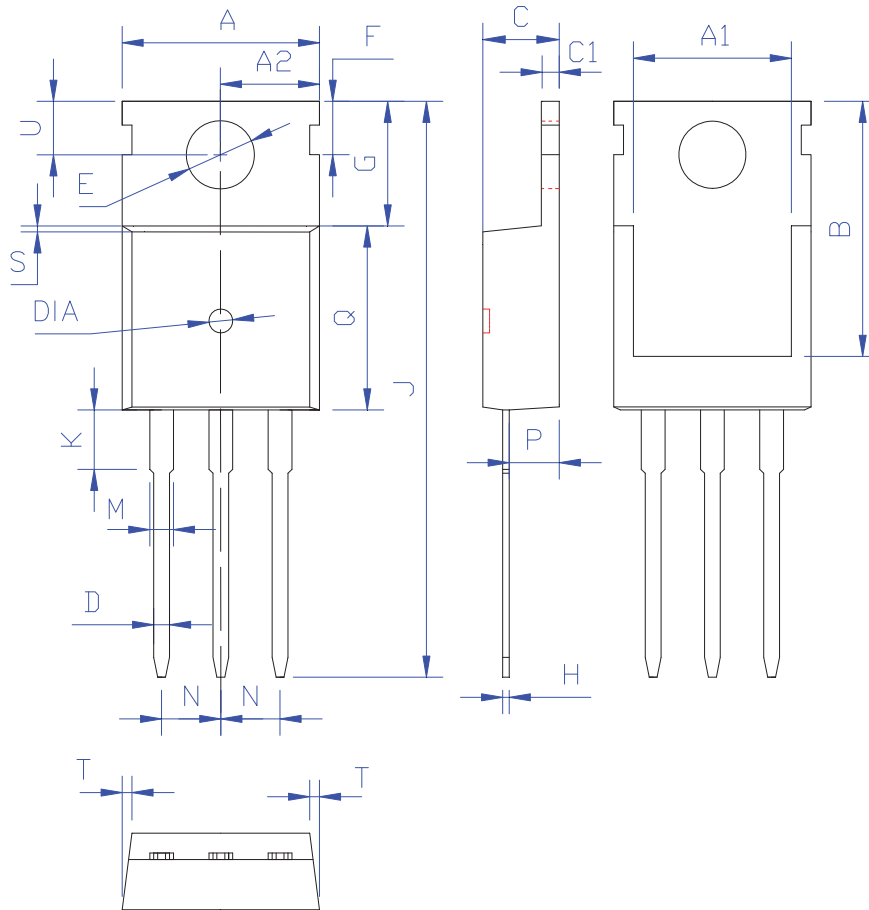

DIM	MILLIMETERS
A	10.00 ± 0.30
A1	8.00 ± 0.30
A2	5.00 ± 0.30
B	13.20 ± 0.40
C	4.50 ± 0.20
C1	1.30 ± 0.20
D	0.80 ± 0.20
E	3.60 ± 0.20
F	3.00 ± 0.30
G	6.60 ± 0.40
H	0.50 ± 0.20
J	28.88 ± 0.50
K	3.00 ± 0.30
M	1.30 ± 0.30
N	Typical 2.54
P	2.40 ± 0.40
Q	9.20 ± 0.40
S	0.25 ± 0.15
T	0.25 ± 0.15
U	2.80 ± 0.30
DIA	宽 1.50 ± 0.10 深 0.50 MAX

(Unit: mm)