



# 肖特极势垒二极管 SCHOTTKY BARRIER DIODE FHP20200A/FHF20200A

## 主要参数 MAIN CHARACTERISTICS

$I_{F(AV)}$	20(2×10)A
$V_{RRM}$	200 V
$V_F$ -typ ( @ $I_F=10A$ )	0.88V
$T_J$	150°C

## 产品特性 FEATURES

共阴结构	Common cathode structure
低功耗	Low power loss
高抗浪涌电流能力	Improved surge current capability
RoHS 产品	RoHS product

## 用途 APPLICATIONS

高频开关电源	High frequency switch power supply
极性保护电路	Polarity protection application

## 封装形式 Package

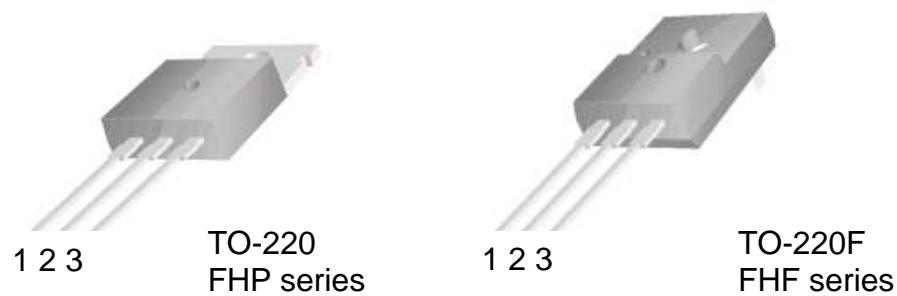

## 等效电路 Equivalent Circuit



## 绝对最大额定值 ABSOLUTE RATINGS ( $T_c=25^\circ C$ )

项 目 Parameter	符 号 Symbol	数 值 Value	单 位 Unit
最大反向重复峰值电压 Repetitive peak reverse voltage	$V_{RRM}$	200	V
最大直流阻断电压 Maximum DC blocking voltage	$V_{DC}$	200	V
正向平均整流电流 Average forward current	$I_{F(AV)}$	20	A
整个器件 per device 单 侧 per diode		10	
正向峰值浪涌电流 Surge non repetitive forward current (额定负载 8.3ms 半正弦波—按 JEDEC 方法) 8.3 ms single half-sine-wave (JEDEC Method)	$I_{FSM}$	250	A
最高结温 Maximum junction temperature	$T_j$	150	°C
储存温度 Storage temperature range	$T_{STG}$	-40~+150	°C

## 电特性 ELECTRICAL CHARACTERISTICS

项 目 Parameter	测试条件 Tests conditions		最小值 Value (min)	典型值 Value (typ)	最大值 Value (max)	单 位 Unit
$I_R$	$T_a = 25^\circ C$	$V_R = V_{RRM}$	-	1.0	10	$\mu A$
	$T_a = 125^\circ C$		-	-	1	mA
$V_F$	$T_a = 25^\circ C$	$I_F = 10A$	-	0.88	0.95	V
	$T_a = 125^\circ C$		-	0.75	0.87	V

---

## 热特性 THERMAL CHARACTERISTIC

项 目 Parameter		符 号 Symbol	最大值 Value (max)	单 位 Unit
结到管壳的热阻 Thermal resistance from junction to case	TO-220	Rth(j-c)	1.8	°C/W
	TO-220F		3.5	

印记 Marking:

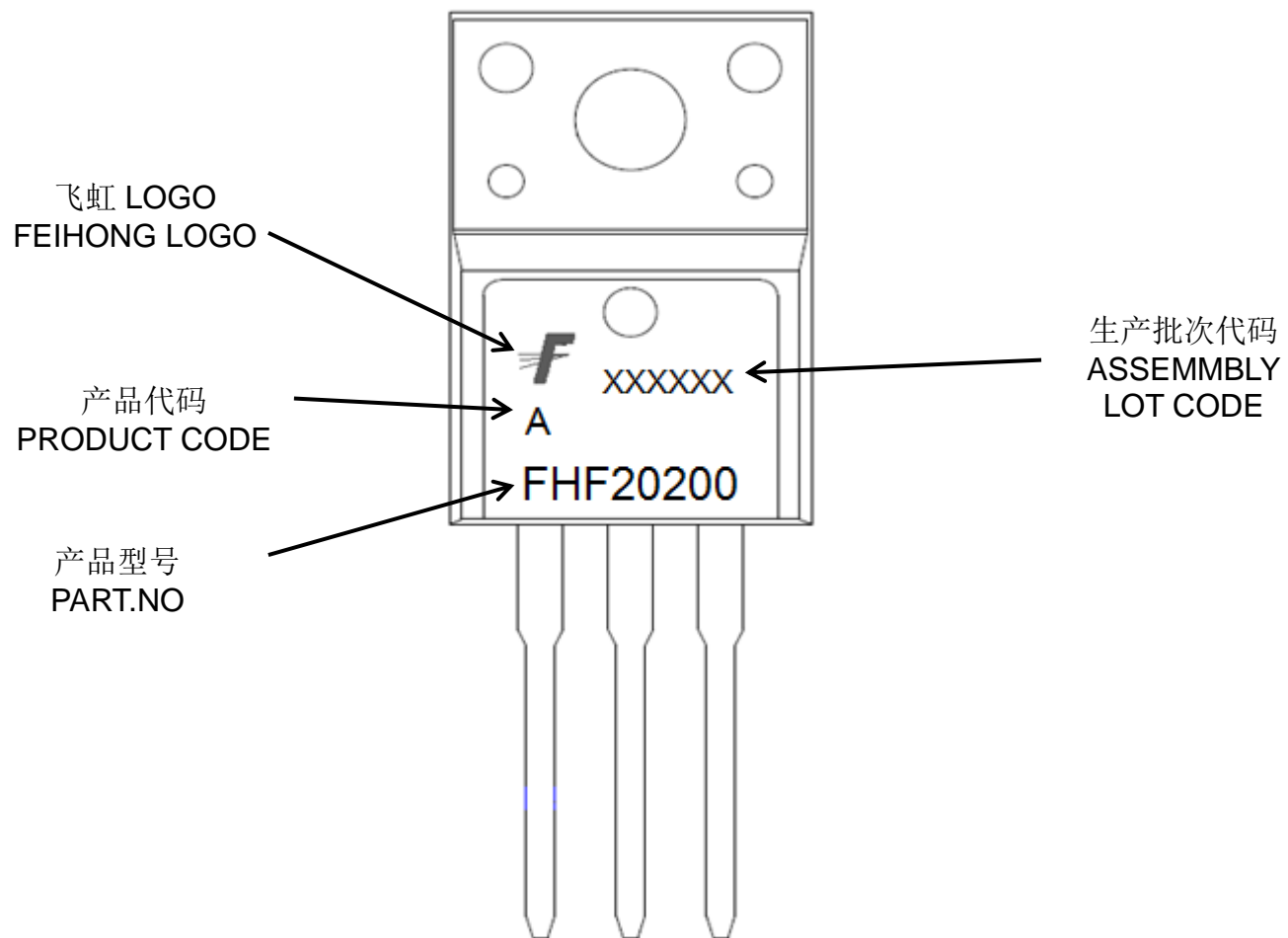
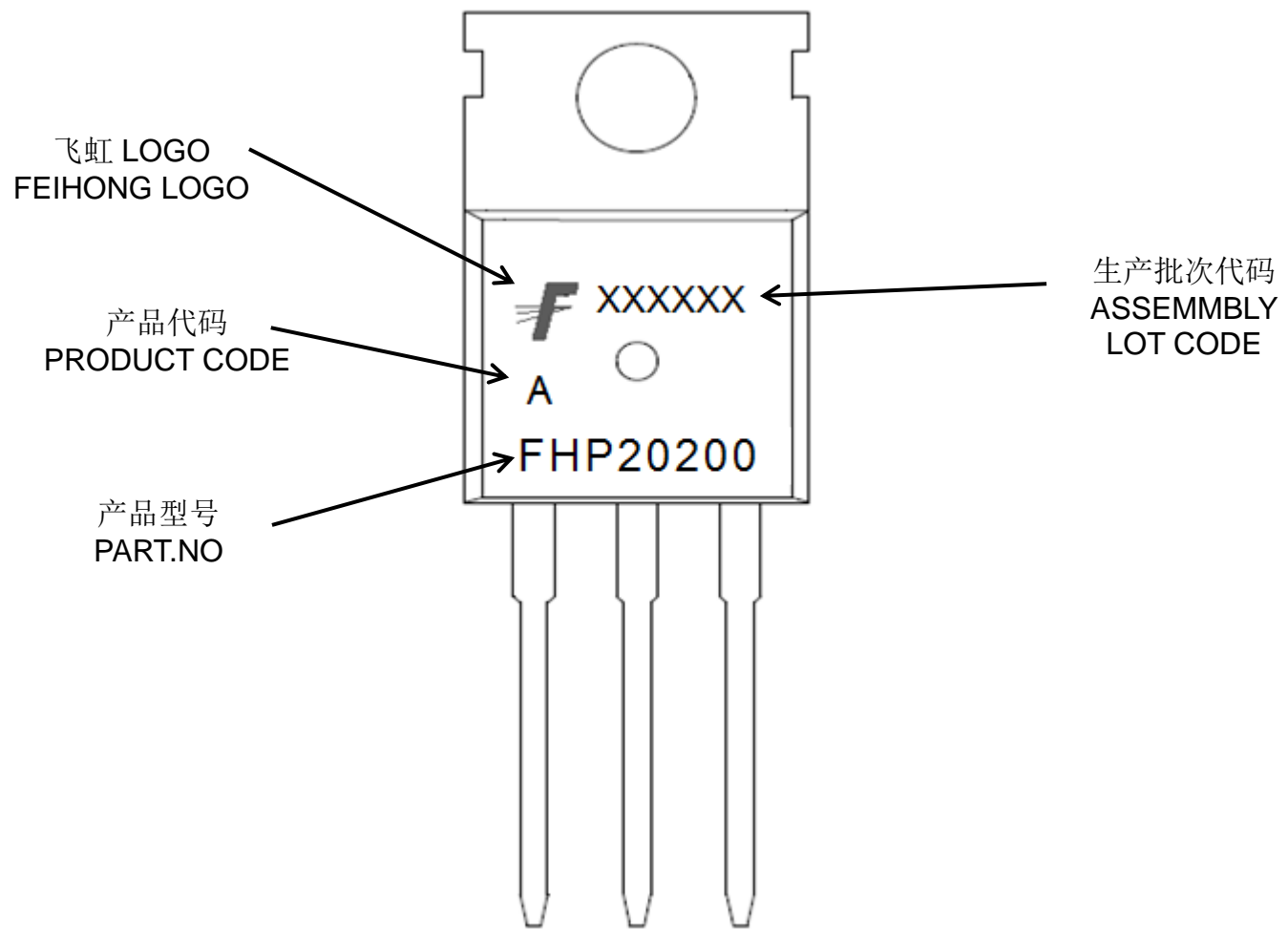

# 特性曲线

## (ELECTRICAL CHARACTERISTICS (curves))

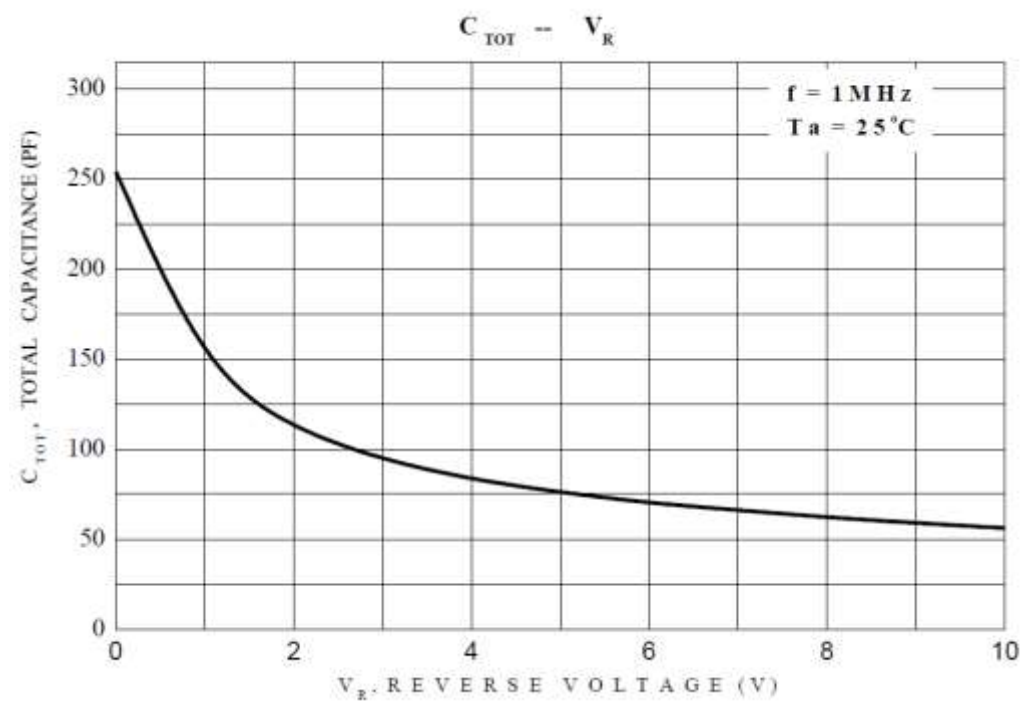
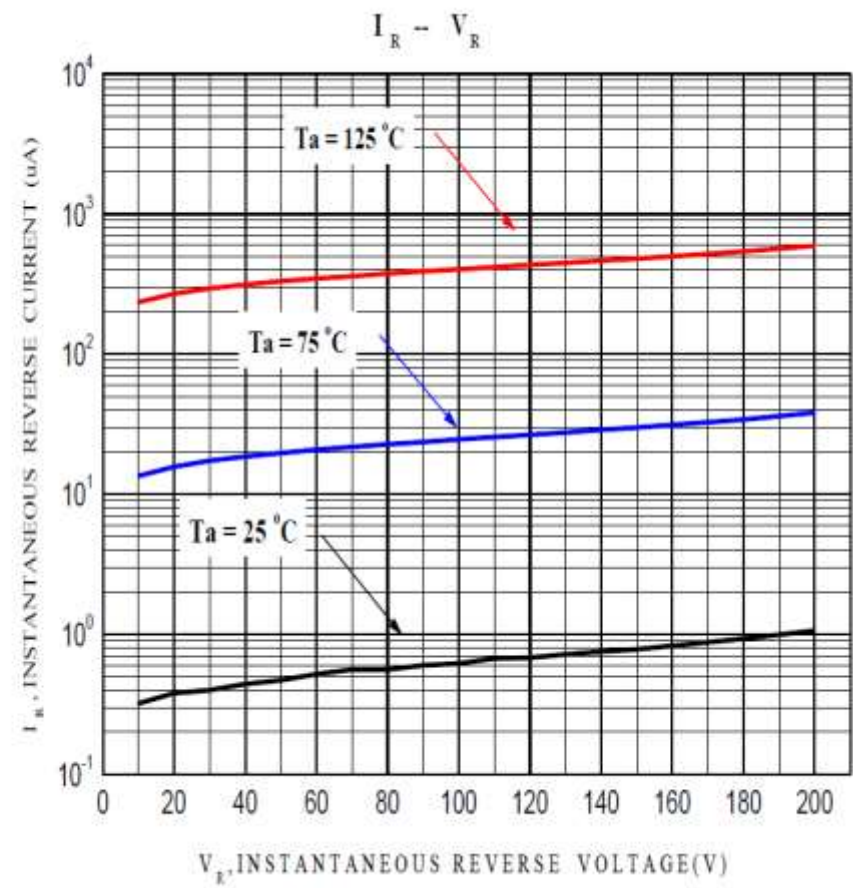
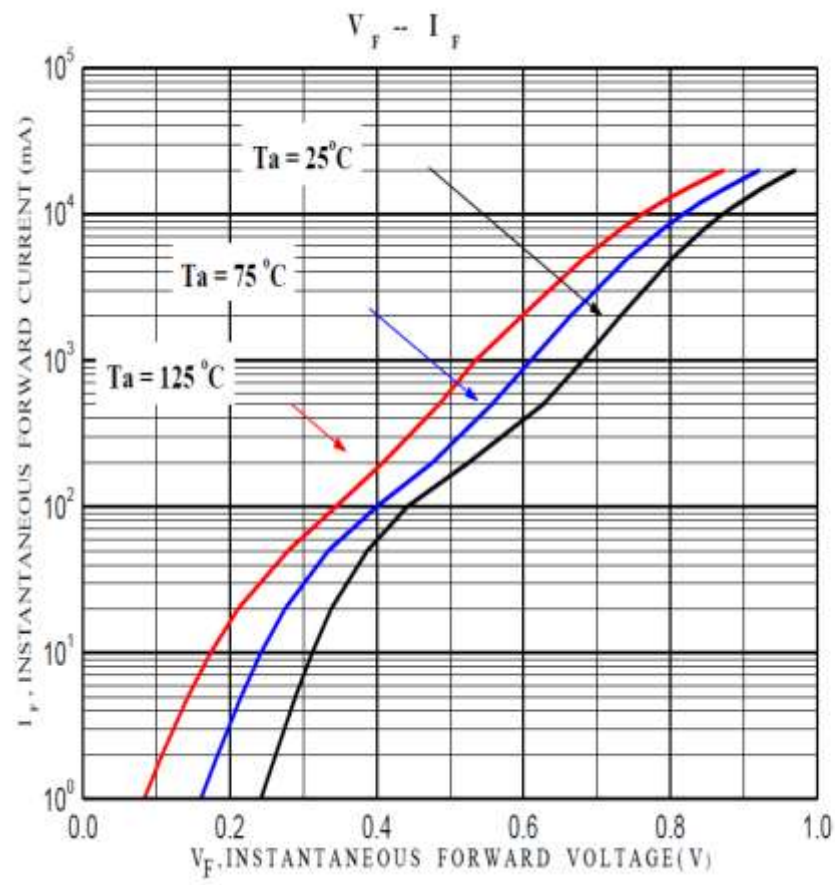

外形尺寸:

Package Dimension:

TO-220

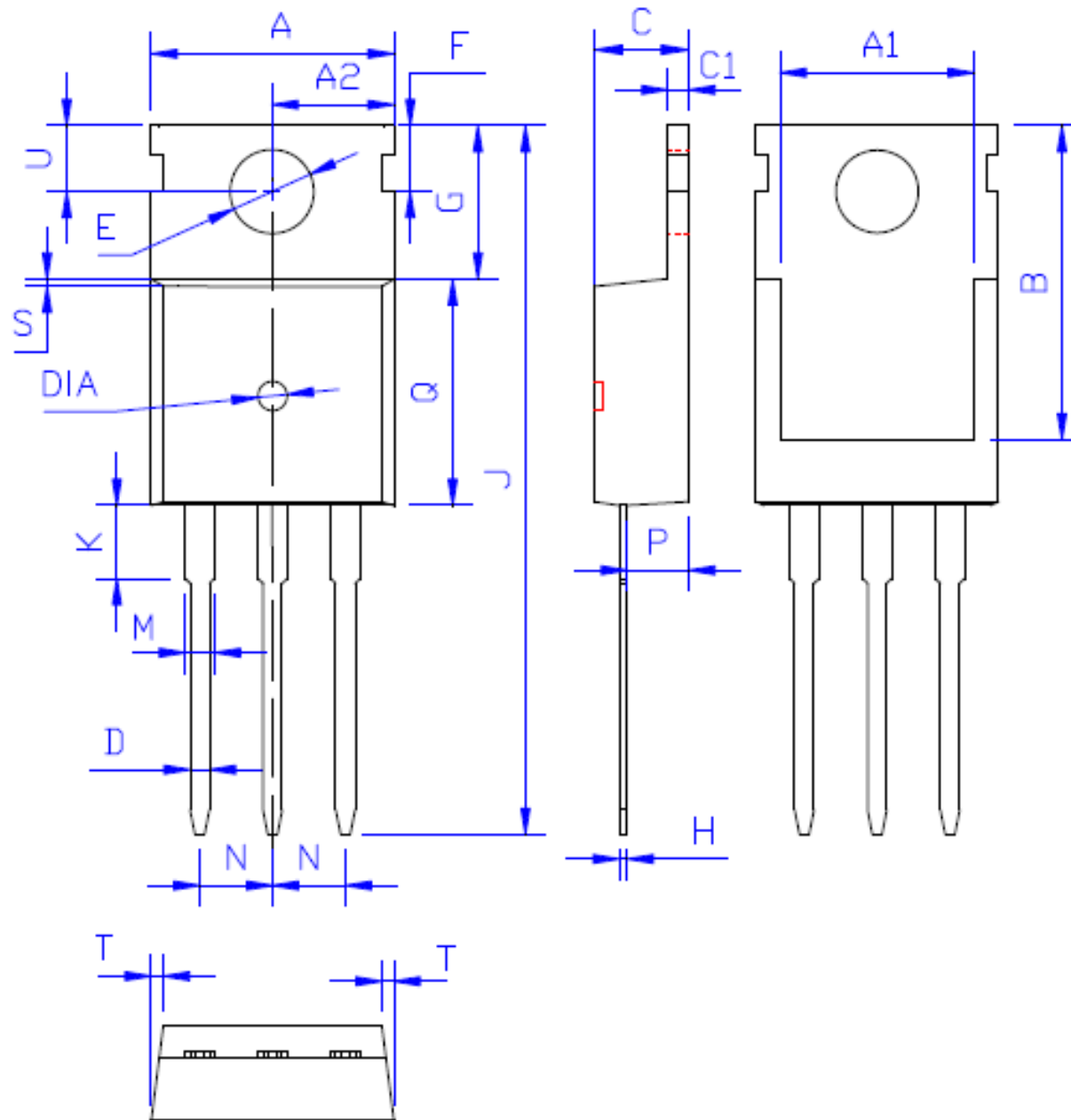

DIM	MILLIMETERS
A	10.00 ± 0.30
A1	8.00 ± 0.30
A2	5.00 ± 0.30
B	13.20 ± 0.40
C	4.50 ± 0.20
C1	1.30 ± 0.20
D	0.80 ± 0.20
E	3.60 ± 0.20
F	3.00 ± 0.30
G	6.60 ± 0.40
H	0.50 ± 0.20
J	28.88 ± 0.50
K	3.00 ± 0.30
M	1.30 ± 0.30
N	Typical 2.54
P	2.40 ± 0.40
Q	9.20 ± 0.40
S	0.25 ± 0.15
T	0.25 ± 0.15
U	2.80 ± 0.30
DIA	宽 1.50 ± 0.10 深 0.50 MAX

(Unit: mm)

外形尺寸:

Package Dimension:

TO-220F

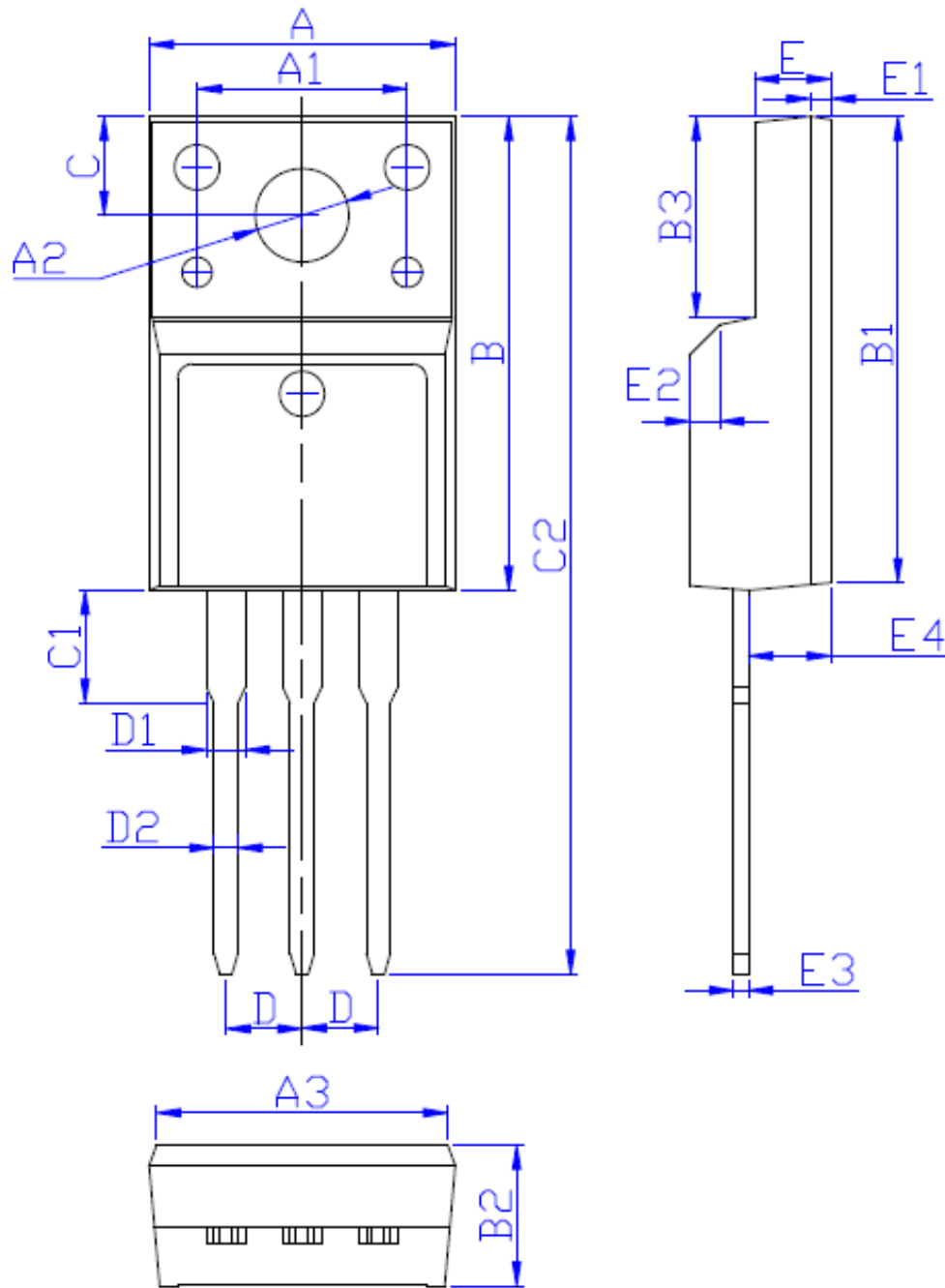

DIM	MILLIMETERS
A	10.16±0.30
A1	7.00±0.20
A2	3.12±0.20
A3	9.70±0.30
B	15.90±0.50
B1	15.60±0.50
B2	4.70±0.30
B3	6.70±0.30
C	3.30±0.25
C1	3.25±0.30
C2	28.70±0.50
D	Typical 2.54
D1	1.47 (MAX)
D2	0.80±0.20
E	2.55±0.25
E1	0.70±0.25
E2	1.0×45°
E3	0.50±0.20
E4	2.75±0.30

(Unit:mm)