



晶体管 TRANSISTOR C945B

主要参数 MAIN CHARACTERISTICS

I _c	150mA
V _{CEO}	52V
V _{CB0}	70V
P _c	400mW

产品特性 FEATURES

硅外延	Epitaxial silicon
高开关速度	High switching speed
RoHS 产品	RoHS product

用途 APPLICATIONS

高频开关电源	High frequency switch power supply
一般功率放大电路	Commonly power amplifier circuit
高频功率变换	High frequency power transform

封装形式 Package



绝对最大额定值 ABSOLUTE RATINGS (T_c=25°C)

项目 Parameter	符号 Symbol	数值 Value	单位 Unit
集电极—基极直流电压 Collector- Base Voltage (I _E =0)	V _{CB0}	70	V
集电极—发射极直流电压 Collector- Emitter Voltage (I _B =0)	V _{CEO}	52	V
发射极—基极直流电压 Emitter-Base Voltage (I _C =0)	V _{EB0}	5.5	V
最大集电极直流电流 Collector Current (DC)	I _c	150	mA
最大集电极耗散功率 Total Dissipation (TO-92)	P _c	400	mW
最高结温 Junction Temperature	T _j	150	°C
贮存温度 Storage Temperature	T _{stg}	-55~+150	°C

电特性 ELECTRICAL CHARACTERISTICS

项目 Parameter	测试条件 Tests conditions	最小值 (min)	典型值 (typ)	最大值 (max)	单位 Unit
V(BR) _{CBO}	I _C =100μA, I _E =0	70	-	-	V
V(BR) _{CEO}	I _C =2mA, I _B =0	52	-	-	V
V(BR) _{EBO}	I _E =100μA, I _C =0	5.5	-	-	V
I _{CBO}	V _{CB} =50V, I _E =0	-	-	100	nA
I _{EBO}	V _{EB} =5V, I _C =0	-	-	100	nA
H _{fe} (1)	V _{CE} =6V, I _C =2mA	90	-	600	-
H _{fe} (2)	V _{CE} =6V, I _C =150mA	25	-	-	-
V _{CE(sat)}	I _C =100mA, I _B =10mA	-	-	0.3	V
V _{BE(sat)}	I _C =100mA, I _B =10mA	-	-	1.1	V

放大倍数h_{FE} Classifications

h _{FE} Classifications Symbol	R	Q	P	K
h _{FE} Range	90-180	135-270	200-400	300-600

典型特性曲线 Electrical Characteristics

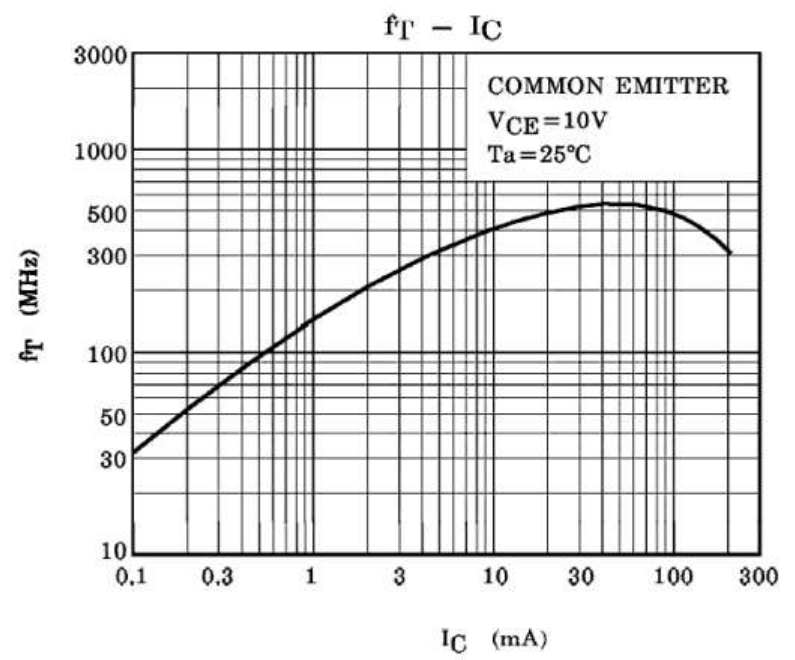
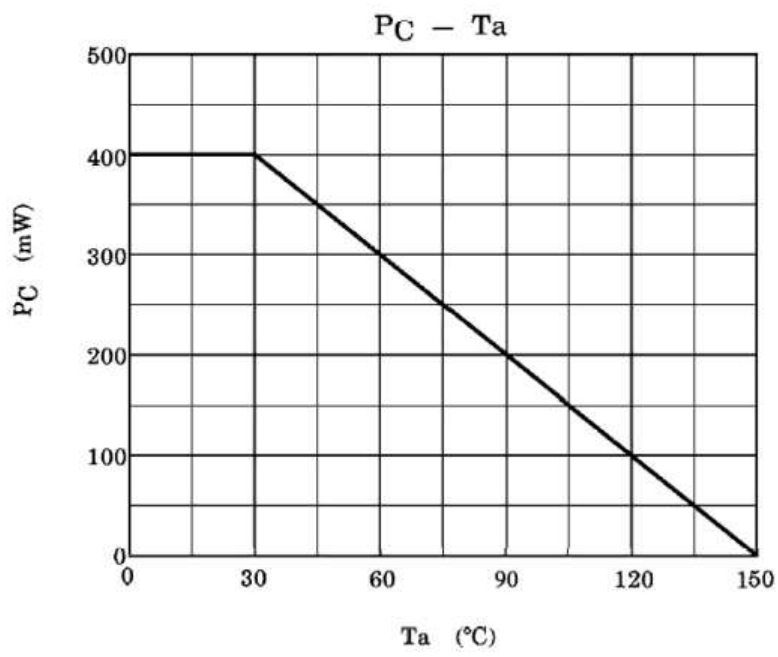
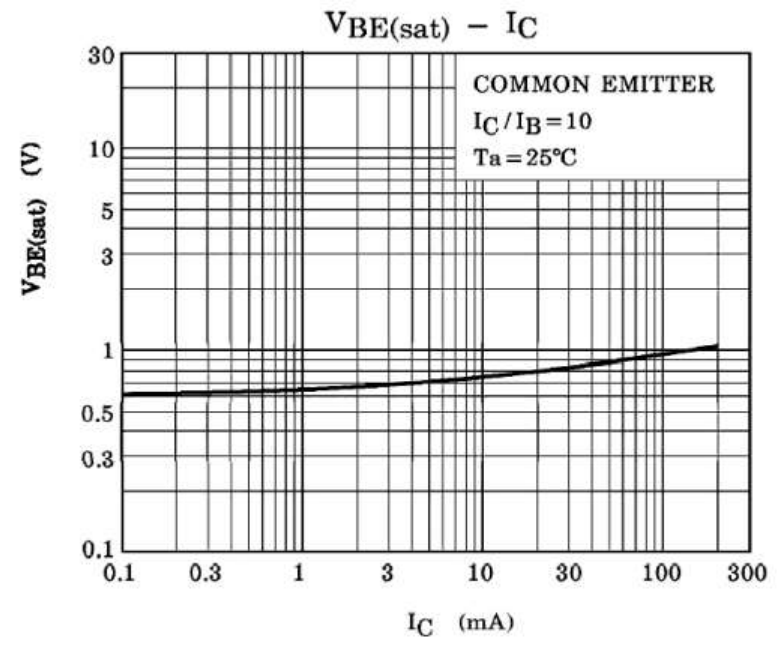
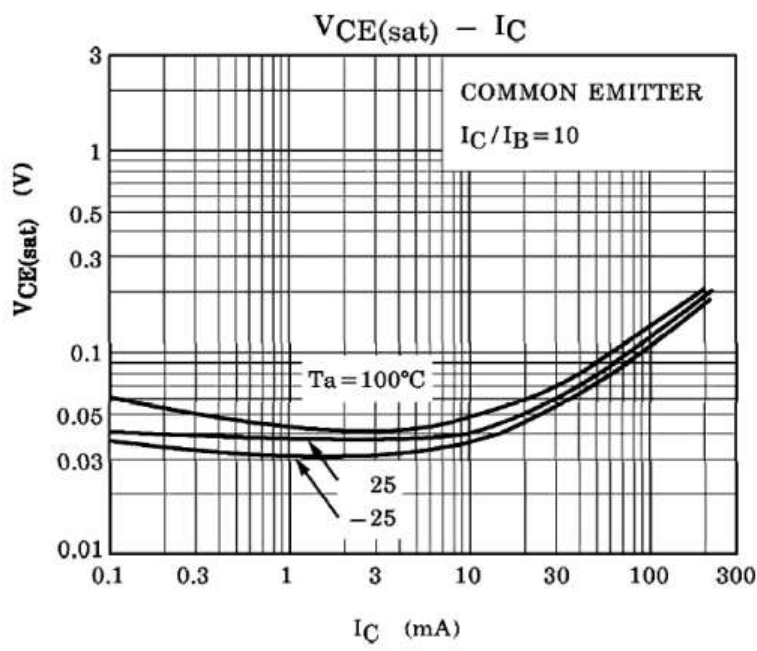
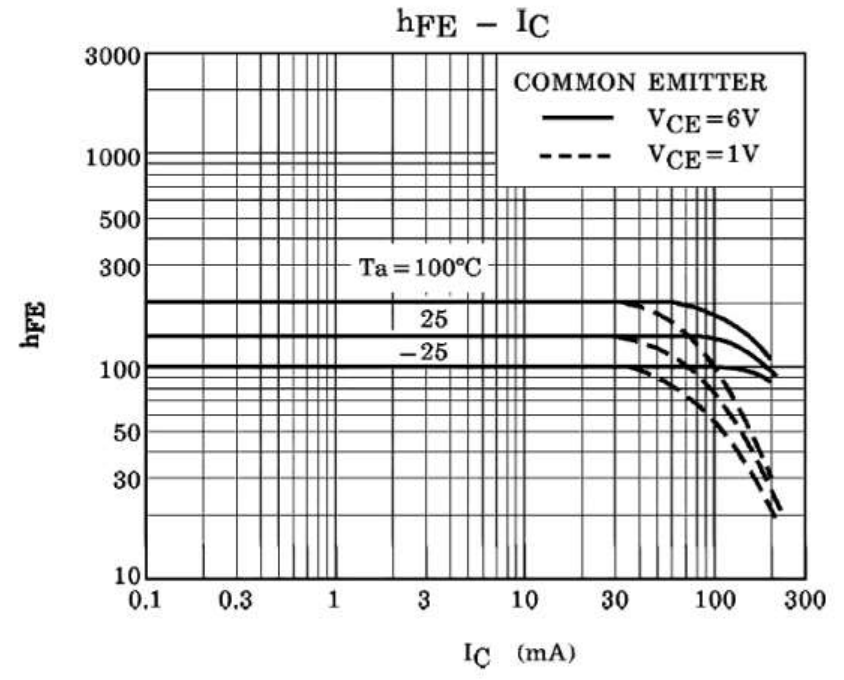
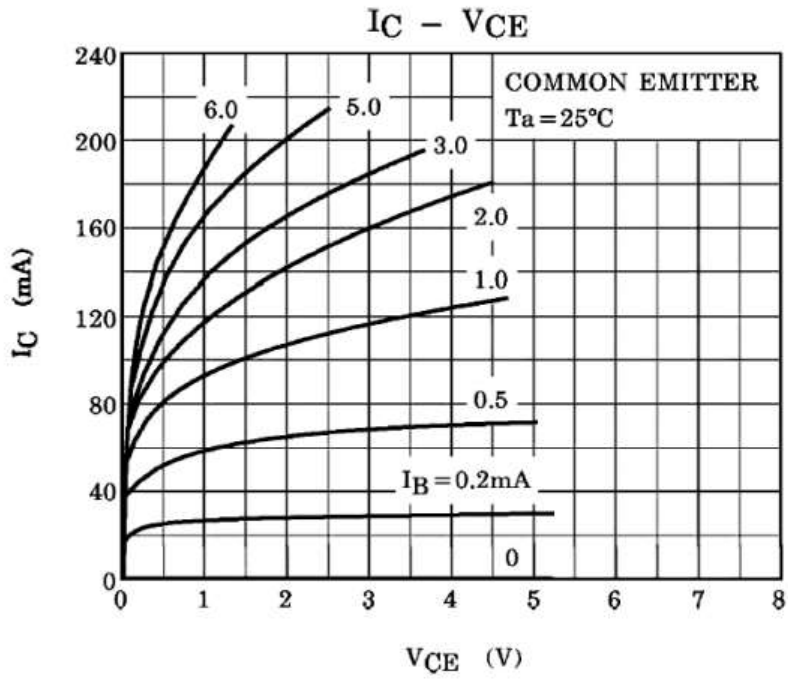

印记 Marking:

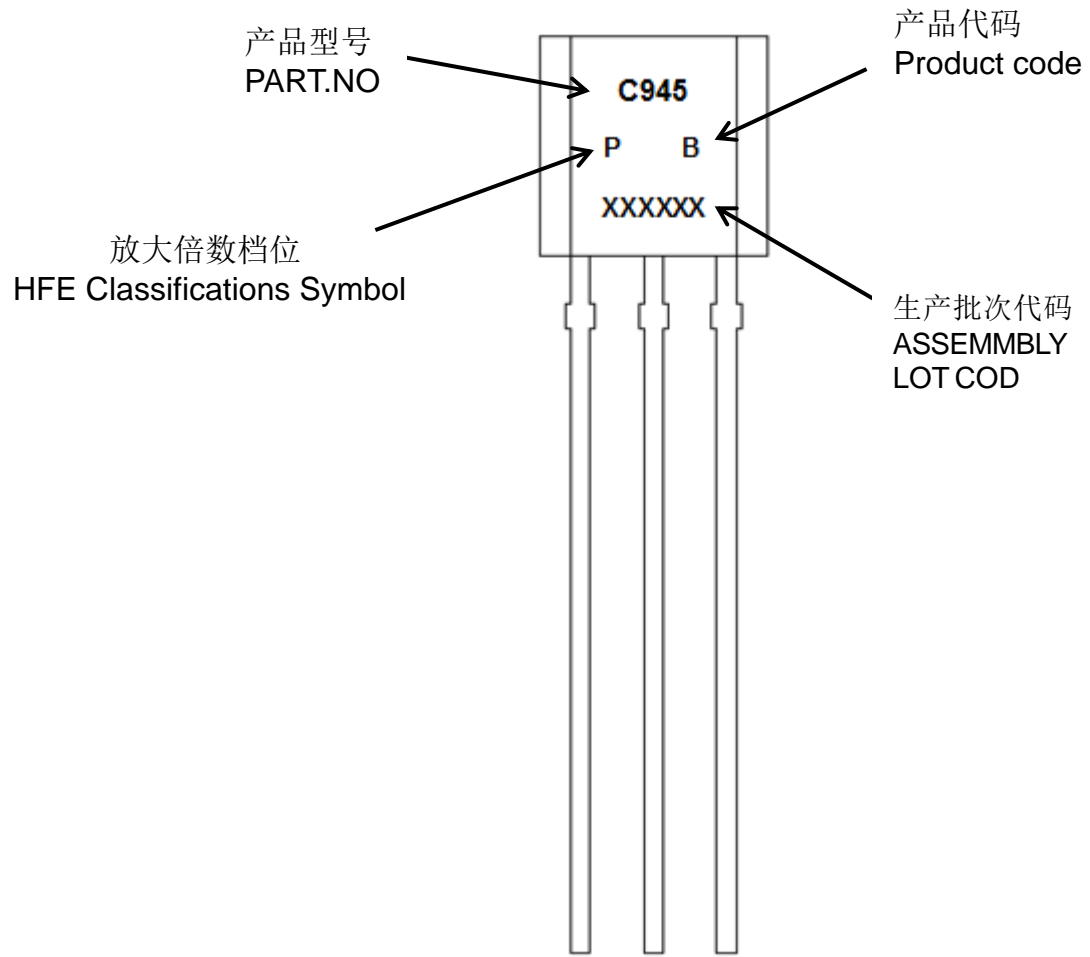

外形尺寸:
Package Dimension

T0-92

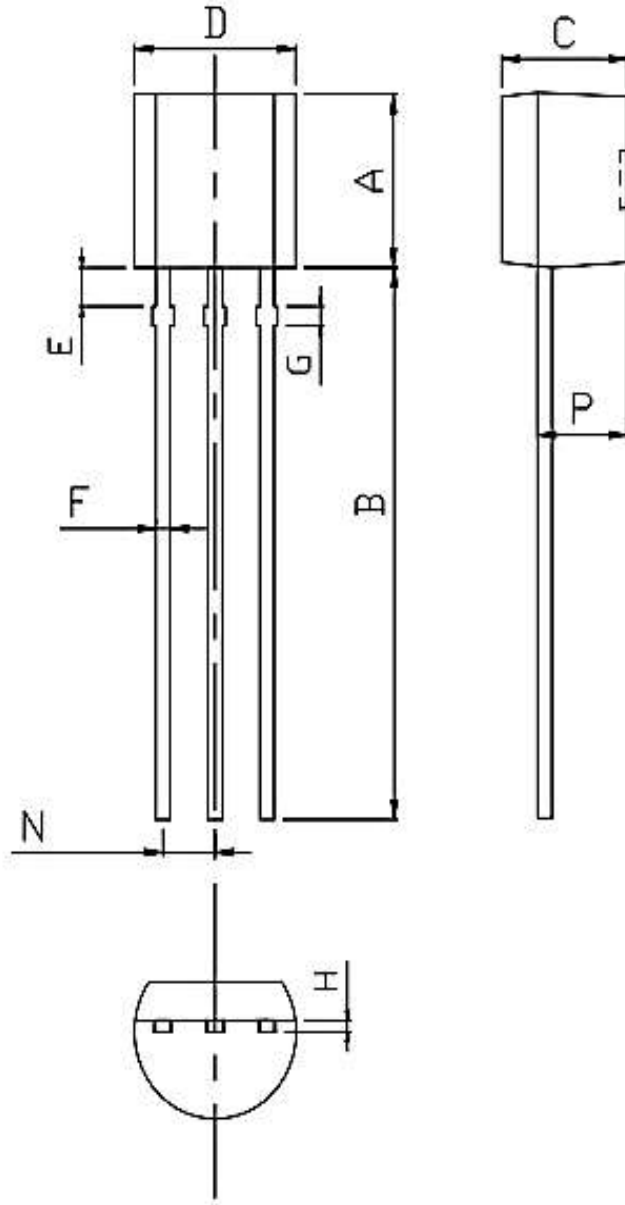

DIM	MILLIMETERS
A	4.55±0.20
B	14.50±0.30
C	3.54±0.20
D	4.56±0.20
E	1.30±0.20
F	0.46±0.20
G	0.50±0.10
H	0.32±0.10
N	1.30±0.20
P	2.52±0.20

Unit : (mm)