

# SR520 THRU SR5200

## 5.0A Axial Leaded Schottky Barrier Rectifiers - 20V-200V

### Features

- Axial lead type devices for through hole design
- Low power loss, high efficiency.
- High current capability, low forward voltage drop.
- High surge capability.
- Guardring for overvoltage protection.
- Ultra high-speed switching.
- Silicon epitaxial planar chip, metal silicon junction.
- Lead-free parts meet environmental standards of MIL-STD-19500 /228
- Suffix "-H" for Halogen-free part, ex.SR520-H

### Mechanical data

- Epoxy : UL94-V0 rated flame retardant
- Case : Molded plastic, DO-201AD
- Lead : Axial leads, solderable per MIL-STD-202, Method 208 guaranteed
- Polarity: Color band denotes cathode end
- Mounting Position : Any

### Package outline

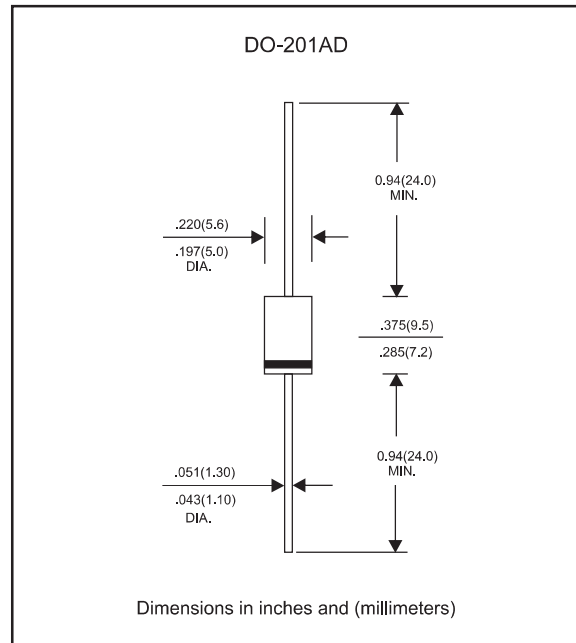

### Maximum ratings and Electrical Characteristics (AT $T_A=25^\circ\text{C}$ unless otherwise noted)

PARAMETER	CONDITIONS	Symbol	MIN.	TYP.	MAX.	UNIT
Forward rectified current	See Fig.2	$I_o$			5.0	A
Forward surge current	8.3ms single half sine-wave (JEDEC methode)	$I_{FSM}$			120	A
Reverse current	$V_R = V_{RRM}$ $T_J = 25^\circ\text{C}$	$I_R$			0.5	mA
	$V_R = V_{RRM}$ $T_J = 100^\circ\text{C}$				1.0	
Thermal resistance	Junction to ambient Junction to lead	$R_{\theta JA}$		25		$^\circ\text{C/W}$
		$R_{\theta JL}$		10		$^\circ\text{C/W}$
Diode junction capacitance	f=1MHz and applied 4V DC reverse voltage	$C_J$		380		pF
Storage temperature		$T_{STG}$	-65		+175	$^\circ\text{C}$

SYMBOLS	$V_{RRM}^{*1}$ (V)	$V_{RMS}^{*2}$ (V)	$V_R^{*3}$ (V)	$V_F^{*4}$ (V)	Operating temperature $T_J$ , ( $^\circ\text{C}$ )
SR520	20	14	20	0.55	-55 to +125
SR540	40	28	40		
SR545	45	32	45		
SR550	50	35	50	0.70	-55 to +150
SR560	60	42	60		
SR580	80	56	80	0.85	
SR5100	100	70	100		
SR5150	150	105	150	0.92	
SR5200	200	140	200		

\*1 Repetitive peak reverse voltage

\*2 RMS voltage

\*3 Continuous reverse voltage

\*4 Maximum forward voltage@ $I_F=5.0\text{A}$

## Rating and characteristic curves (SR520 THRU SR5200)

FIG.1-TYPICAL FORWARD CURRENT DERATING CURVE

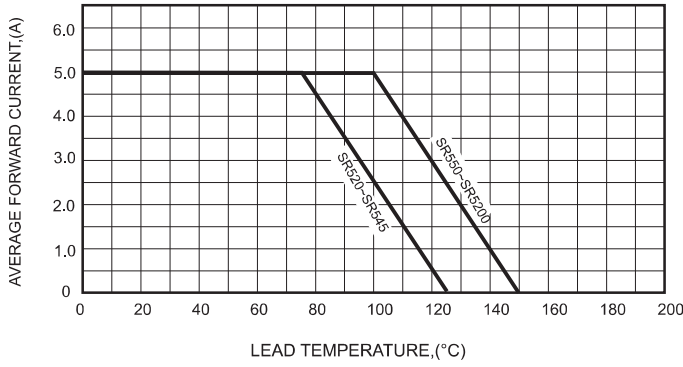

FIG.2-TYPICAL FORWARD CHARACTERISTICS

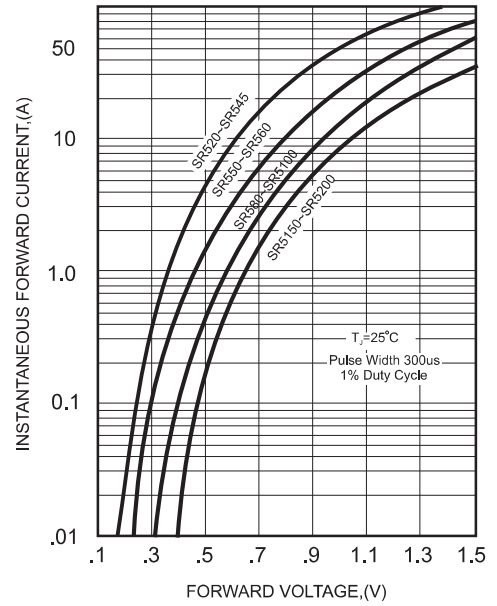

FIG.3-MAXIMUM NON-REPETITIVE FORWARD SURGE CURRENT

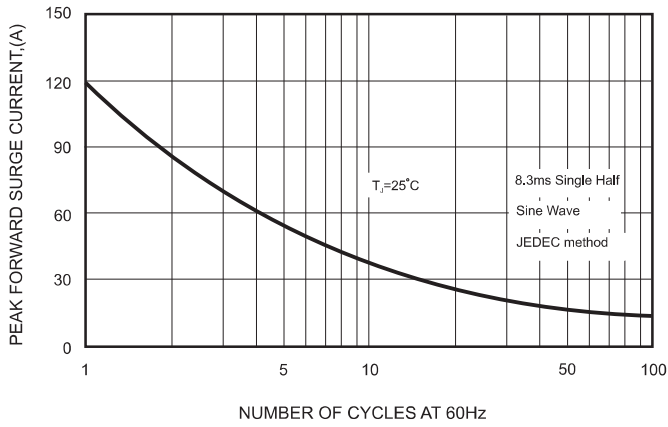

FIG.5 - TYPICAL REVERSE CHARACTERISTICS

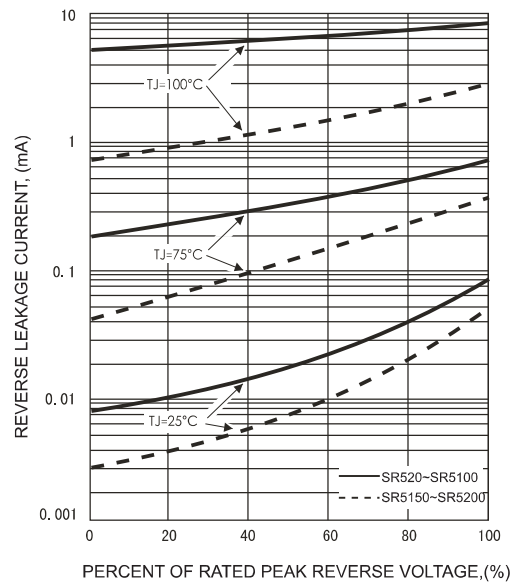
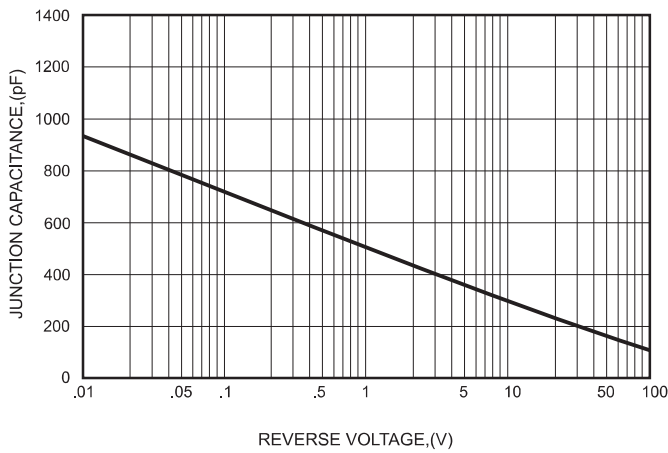

FIG.4-TYPICAL JUNCTION CAPACITANCE



# SR520 THRU SR5200

## Pinning information

Pin	Simplified outline	Symbol
Pin1 cathode Pin2 anode		

## Marking

Type number	Marking code	Example	
SR520	SR520	For Halogen Device	For Halogen-free Device
SR530	SR530		
SR540	SR540		
SR550	SR550		
SR560	SR560		
SR580	SR580		
SR5100	SR5100		
SR5150	SR5150		
SR5200	SR5200		

## Taping specifications for AXIAL devices

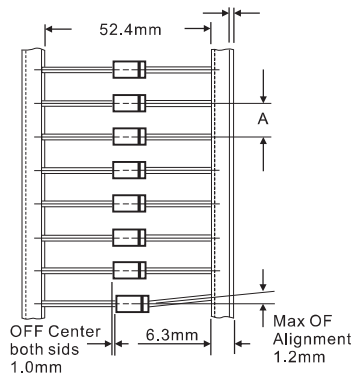

## AMMO PACKING

DEVICE CASE TYPE	Q'TY 1 (PCS / BOX)	INNER BOX SIZE (m/m)	CARTON SIZE (m/m)	Q'TY 2 (PCS / CARTON)	APPROX. CROSS WEIGHT(kg)
DO-201AD	1,250	258 * 75 * 143	405 * 270 * 320	12,500	14.0