

MB05S THRU MB10S

0.8A Miniature Glass Passivated Single-Phase Surface Mount Bridge Rectifiers-50-1000V

Features

- Surge overload ratings to 30 amperes peak.
- Save space on printed circuit board.
- Ideal for automated replacement.
- Reliable low cost construction utilizing molded plastic technology results in inexpensive product.
- Glass passivated chip junctions.
- Lead-free parts meet RoHS requirements.
- UL recognized file # E321971
- Suffix "-H" indicates Halogen free part, ex. MB05S-H.

Mechanical data

- Epoxy:UL94-V0 rated flame retardant
- Case : Molded plastic, TO-269AA (MDS)
- Terminals : Solder plated, solderable per MIL-STD-750, Method 2026
- Polarity : marked on body
- Mounting Position : Any

Package outline

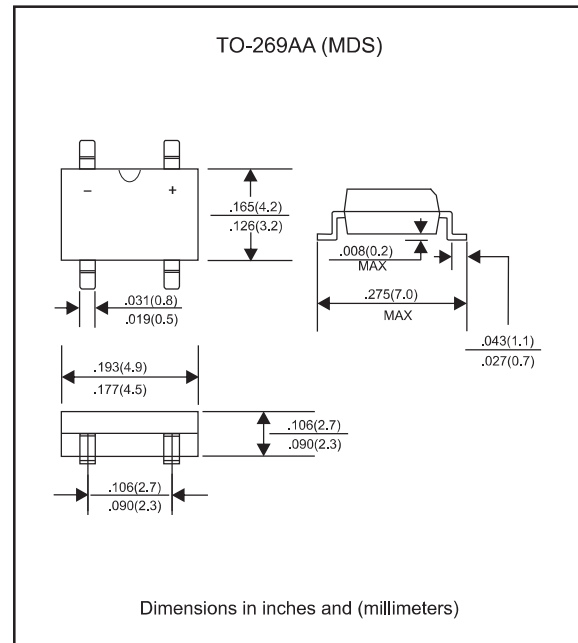

Maximum ratings and Electrical Characteristics (AT $T_A=25^{\circ}\text{C}$ unless otherwise noted)

PARAMETER	CONDITIONS	Symbol	MIN.	TYP.	MAX.	UNIT
Forward rectified current	On glass-epoxy P.C.B. On aluminum substrate	I_O			0.5 0.8	A
Forward surge current	8.3ms single half sine-wave superimposed on rate load (JEDEC method)	I_{FSM}			30	A
Reverse current	$V_R = V_{RRM}$ $T_J = 25^{\circ}\text{C}$	I_R			5.0	uA
	$V_R = V_{RRM}$ $T_J = 125^{\circ}\text{C}$				200	
Thermal resistance	Junction to ambient	$R_{\theta JA}$		85		$^{\circ}\text{C}/\text{W}$
Diode junction capacitance	f=1MHz and applied 4V DC reverse voltage	C_J		13		pF
Storage temperature		T_{STG}	-55		+150	$^{\circ}\text{C}$

SYMBOLS	V_{RRM}^{*1} (V)	V_{RMS}^{*2} (V)	V_R^{*3} (V)	V_F^{*4} (V)	Operating temperature T_{Ji} ($^{\circ}\text{C}$)
MB05S	50	35	50	1.00	-55 to +150
MB1S	100	70	100		
MB2S	200	140	200		
MB4S	400	280	400		
MB6S	600	420	600		
MB8S	800	560	800		
MB10S	1000	700	1000		

*1 Repetitive peak reverse voltage

*2 RMS voltage

*3 Continuous reverse voltage

*4 Maximum forward voltage

per element at 0.8A peak

Rating and characteristic curves (MB05S THRU MB10S)

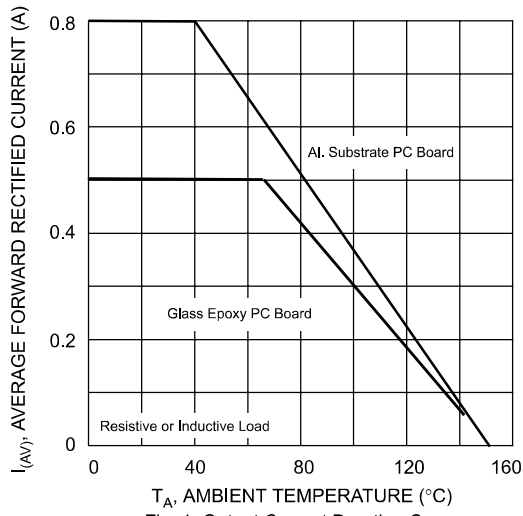

Fig. 1 Output Current Derating Curve

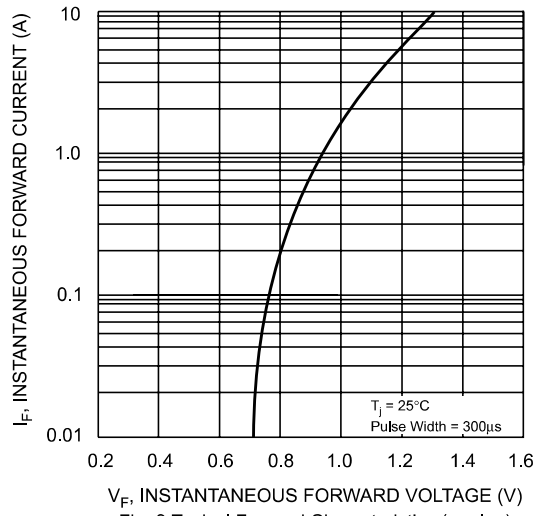

Fig. 2 Typical Forward Characteristics (per leg)

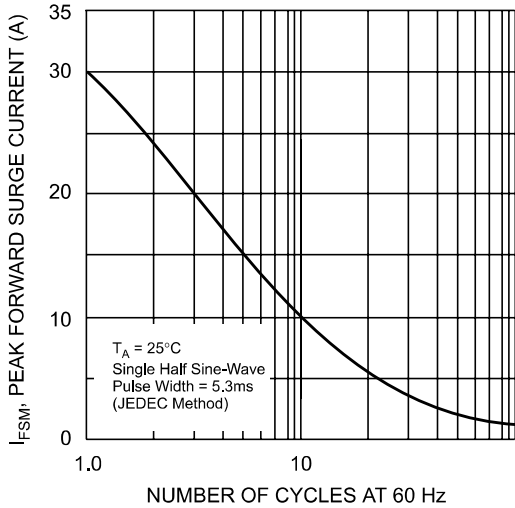

Fig. 3 Maximum Peak Forward Surge Current (per leg)

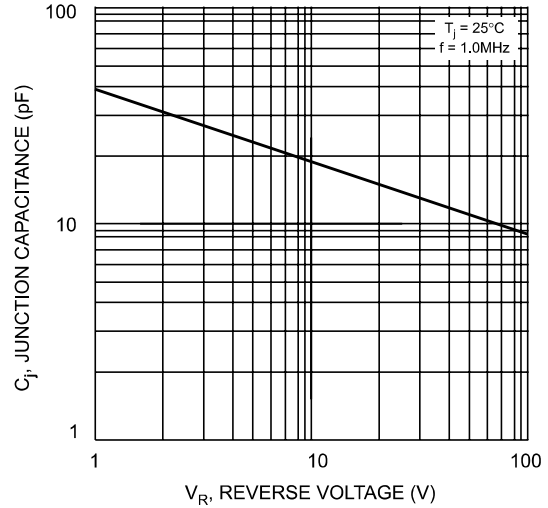

Fig. 4 Typical Junction Capacitance

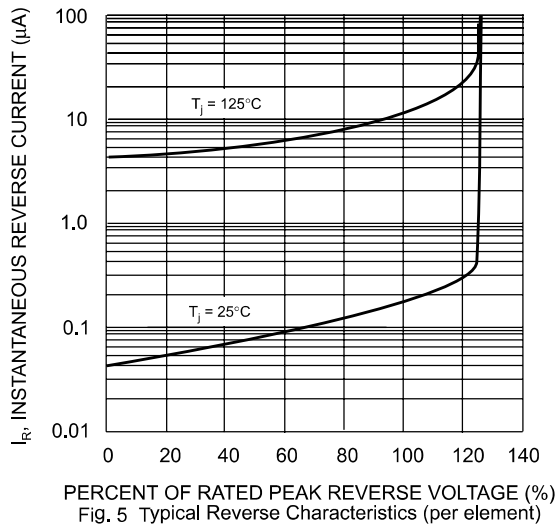
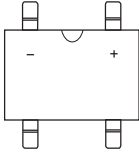
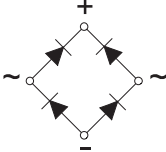

Fig. 5 Typical Reverse Characteristics (per element)

MB05S THRU MB10S

Pinning information

Simplified outline	Symbol
	

Marking

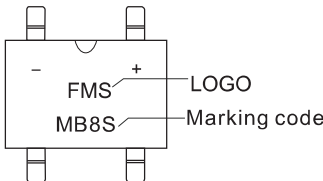
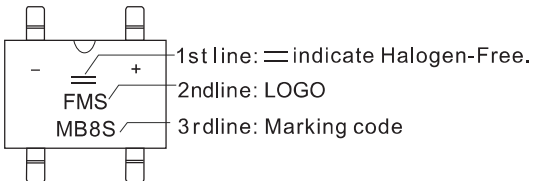
Type number	Marking code	Example	
MB05S MB1S MB2S MB4S MB6S MB8S MB10S	MB05S MB1S MB2S MB4S MB6S MB8S MB10S	1. For Halogen Device 	2. For Halogen-free Device 

Suggested solder pad layout

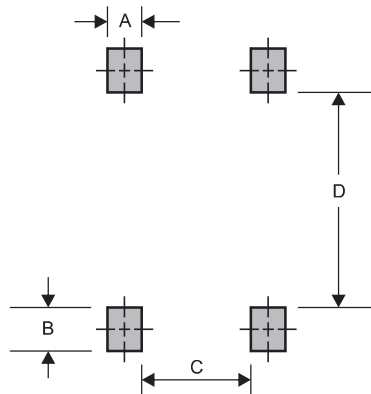

Dimensions in inches and (millimeters)

PACKAGE	A	B	C	D
TO-269AA (MDS)	0.023 (0.58)	0.030 (0.76)	0.070 (1.78)	0.226 (5.75)