

## ■FEATURE:

Fast Response Time.

High Analytic.

Cut-Off Visible Wavelength  $\lambda_p=940\text{nm}$

High sensitivity.

Lead Free product, in compliance with RoHS.

## ■DESCRIPTIONS:

**GK152** consist of an infrared emitting diode and a phototransistor, encased side-by-side on converging optical axis in a black thermoplastic housing the phototransistor receives radiation from the IR LED only. This is the normal situation. But when an object is in between, the phototransistor could not receive the radiation.

## ■APPLICATIONS:

Mouse copier.

Switch scanner.

Floppy disk driver.

Non contact switching.

## ■ DIMENSIONS

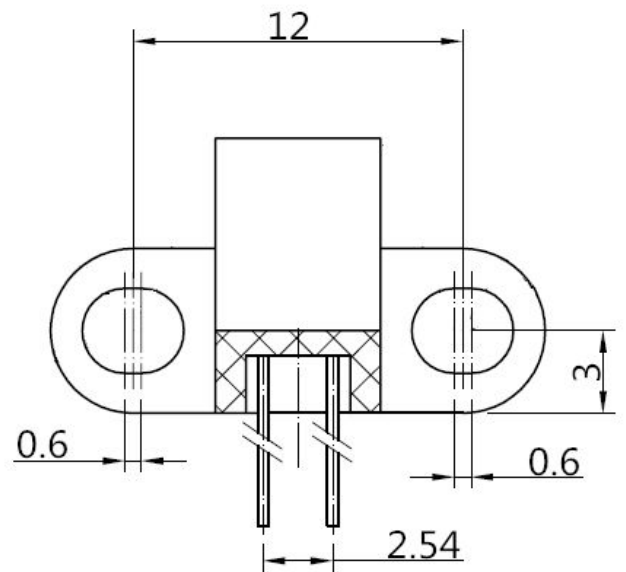
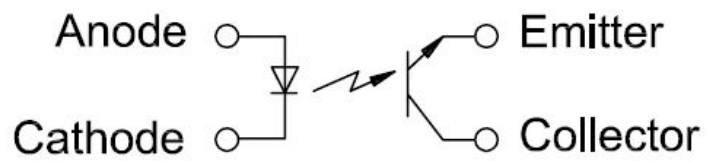
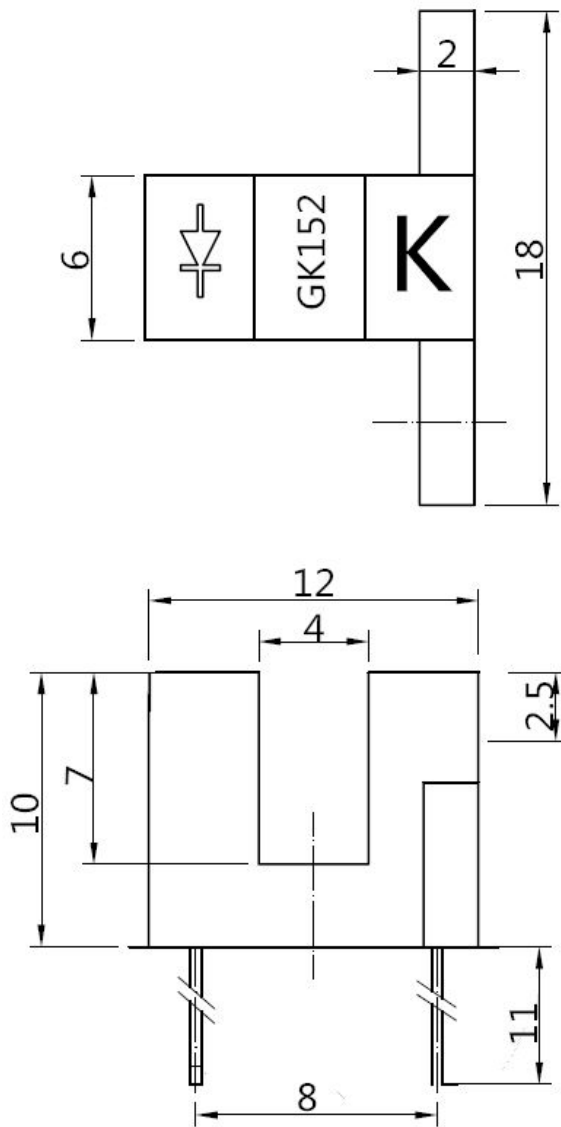

**NOTE:** 1. All dimensions are in millimeter.  
2. Tolerance is  $\pm 0.2$  unless otherwise noted.

## ■ ABSOLUTE MAXIMUM RATINGS AT Ta=25°C

Parameter		Symbol	Ratings	Unit
Input	Power Dissipation	PD	75	mW
	Reverse Voltage	V <sub>R</sub>	5	V
	Forward Current	I <sub>F</sub>	50	mA
	Peak Forward Current	I <sub>FP</sub>	1	A
Output	Collector Power Dissipation	P <sub>C</sub>	75	mW
	Collector Current	I <sub>C</sub>	20	mA
	Collector-Emitter Breakdown Voltage	BV <sub>CEO</sub>	30	V
	Emitter-Collector Breakdown Voltage	BV <sub>ECO</sub>	5	V
Operating Temperature		T <sub>opr</sub>	-25~+85	°C
Storage Temperature		T <sub>stg</sub>	-40~+85	°C
Soldering Temperature		T <sub>sol</sub>	270°C for 6 sec Max (2mm from Body)	

**NOTES: I<sub>FP</sub> CONDITIONS--PULSE WIDTH ≦ 100 μS AND DUTY ≦ 1%.**

## ■ TYPICAL ELECTRICAL & OPTICAL CHARACTERISTICS (Ta=25°C)

Parameter		Symbol	Min.	Type	Max.	Unit	Test Condition
Input	Forward Voltage	V <sub>F</sub>		1.25	1.5	V	I <sub>F</sub> =50 mA
	Reverse Current	I <sub>R</sub>			10	μA	V <sub>F</sub> =5V
	Peak Wavelength	λ <sub>P</sub>		940		nm	
	View Angle	2θ <sub>1/2</sub>		60		Deg	
Output	Collector Dark Current	I <sub>CEO</sub>			100	nA	V <sub>CE</sub> =10V
	Collector-Emitter Saturation Voltage	V <sub>CE(sat)</sub>			0.4	V	I <sub>C</sub> =2mA I <sub>B</sub> =100μA
Transfer Characteristics	On State Collector Current	I <sub>C(on)</sub>	0.5	--	10	mA	V <sub>CE</sub> =5V I <sub>F</sub> =20mA
	Rise Time	T <sub>r</sub>		15		μS	V <sub>CE</sub> =5V I <sub>C</sub> =1mA
	Fall Time	T <sub>f</sub>		15		μS	R <sub>L</sub> =1000Ω

**■RELIABILITY TEST ITEMS AND CONDITIONS:**

<b>NO</b>	<b>Item</b>	<b>Test Conditions</b>	<b>Test Hours/Cycle</b>	<b>Sample Quantity</b>	<b>Test Result</b>
<b>1</b>	<b>Solder Heat</b>	TEMP: 270°C±3°C	10 SEC	11 pcs	0 DEFECT
<b>2</b>	<b>Temperature Cycle</b>	H:+85°C 180min 10min L:-25°C 180min	16 cycles	22 pcs	0 DEFECT
<b>3</b>	<b>Thermal Shock</b>	H:+85°C 30min 30sec L:-25°C 30min	10 cycles	11 pcs	0 DEFECT
<b>4</b>	<b>High Temperature Storage</b>	TEMP: +25°C	1000 HRS	22 pcs	0 DEFECT
<b>5</b>	<b>Low Temperature Storage</b>	TEMP: -25°C	1000 HRS	22 pcs	0 DEFECT
<b>6</b>	<b>High Temperature High Humidity Storage</b>	85°C/93% RH	1000HRS	22 pcs	0 DEFECT

## ■ TYPICAL ELECTRO-OPTICAL CHARACTERISTICS CURVES FOR IR:

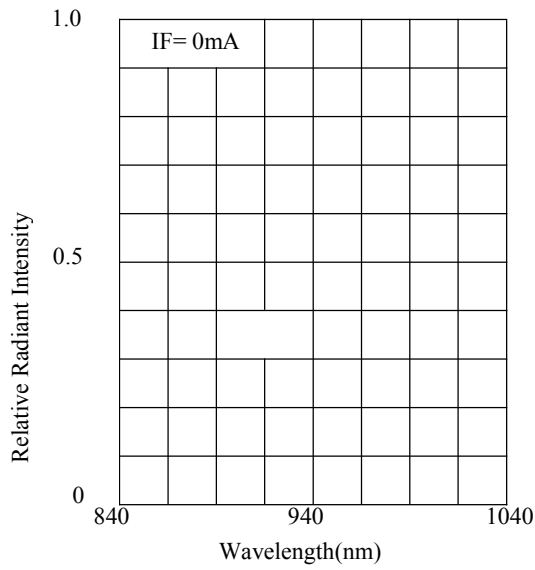

Fig.1 Spectral Distribution

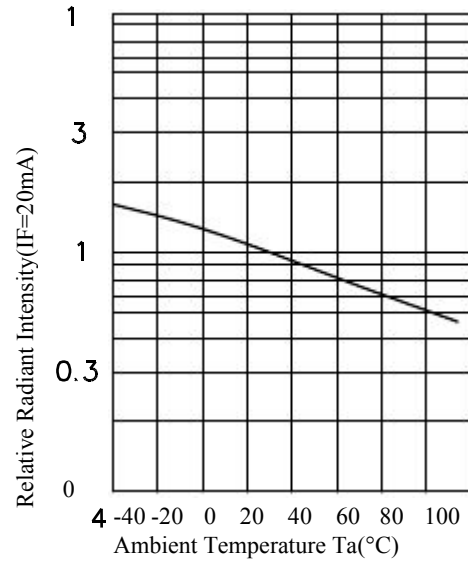

Fig.2 Relative Radiant Intensity Vs Ambient Temperature

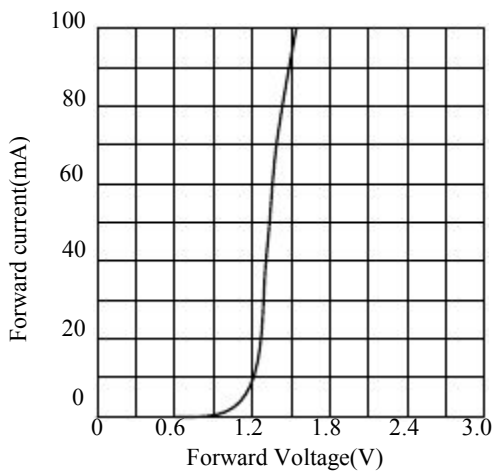

Fig.3 Forward Current Vs Forward Voltage

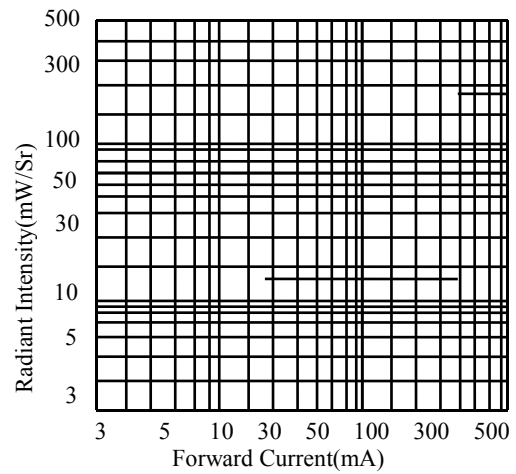

Fig.4 Forward Current Vs Radiant Intensity

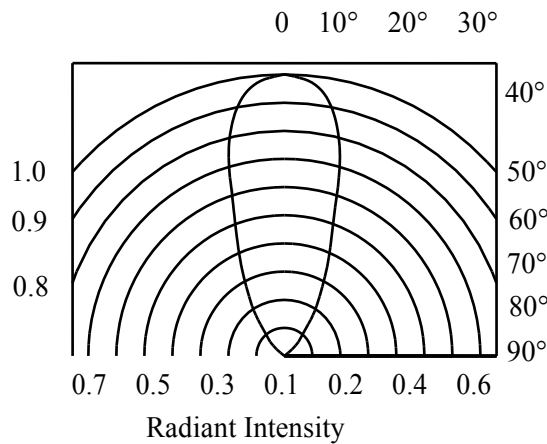

Fig.5 Angle Vs Radiant Intensity

## ■ TYPICAL ELECTRO-OPTICAL CHARACTERISTICS CURVES FOR PT

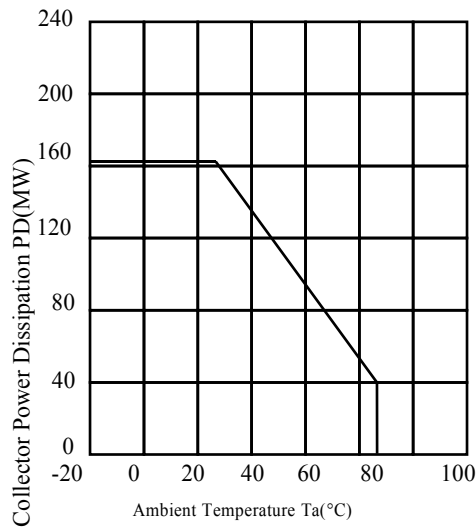

FIG.1 Collector Pd VS Ta

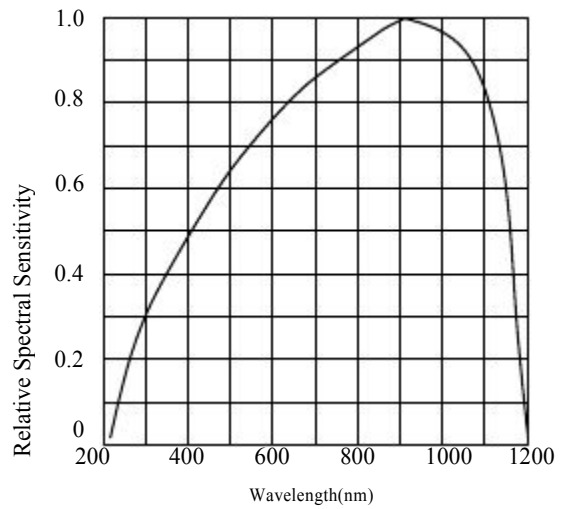

FIG.2 Spectral Sensitivity

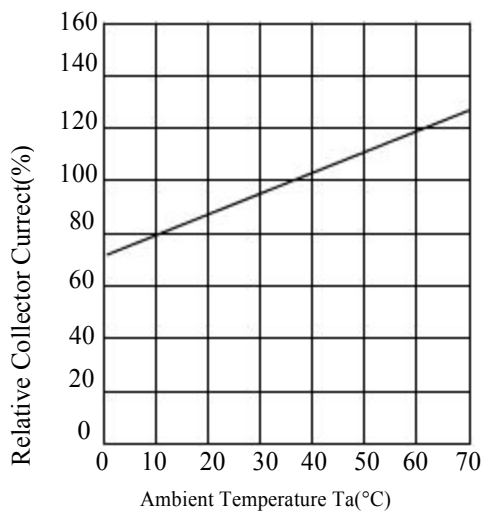

FIG.3 Relative Ic VS Ta

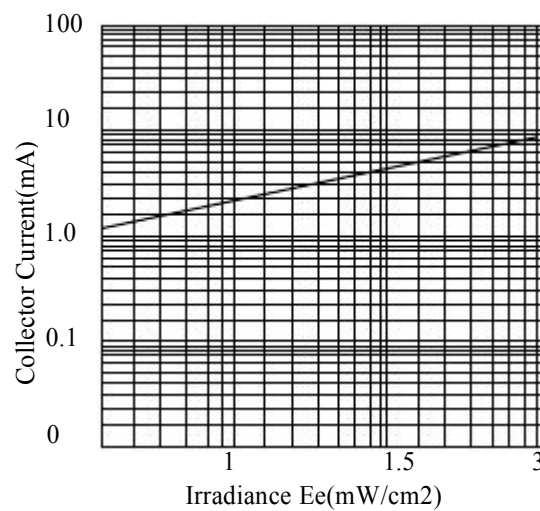

FIG.4 Ic VS Iv

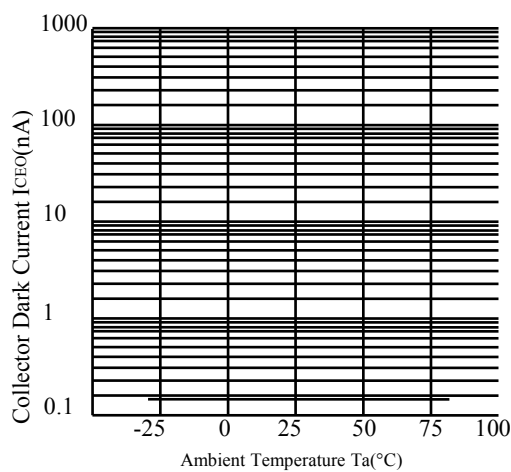

FIG.5 Id VS Ta

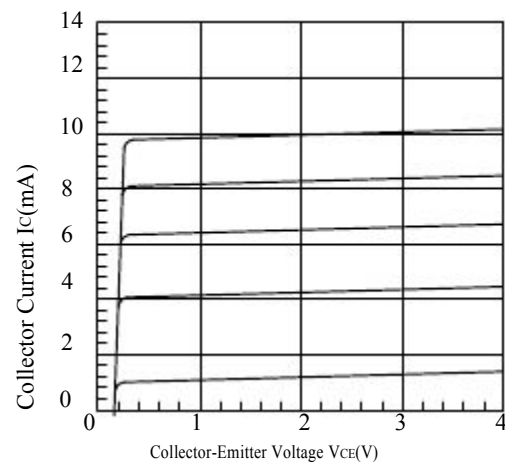

FIG.6 Collector Current VS / Collector-Emitter Voltage