

## SMD ■ Low Power LED 45-21S/KK2C-HXXXXXXXXX2733Z6/2T(SW)



### Features

- PLCC-2 package
- Top view white LED
- High luminous intensity output
- Wide viewing angle
- Pb-free
- RoHS compliant
- ANSI Binning

### Description

The Everlight 45-21S package has high efficacy, high CRI, low power consumption, wide viewing angle and a compact form factor. These features make this package an ideal LED for all lighting applications.

### Applications

- General lighting
- Decorative and Entertainment Lighting
- Indicators
- Illumination
- Switch lights

**Product Number Explanation**

**45-21S/K K 2 C-H XX XX XX XX XXXXZ6 / 2T**

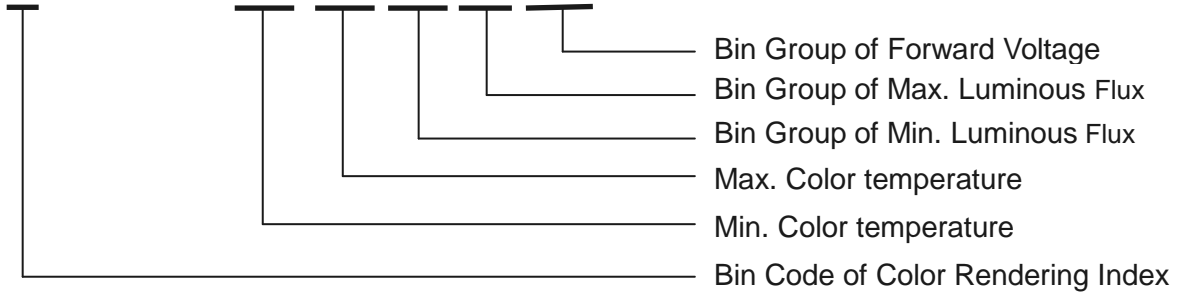

**Table of Color Rendering Index**

Symbol	Description
M	CRI(Min.) : 60
N	CRI(Min.) : 65
L	CRI(Min.) : 70
Q	CRI(Min.) : 75
K	CRI(Min.) : 80
H	CRI(Min.) : 90

Note:  
 Tolerance of Color Rendering Index: ±2

**Table of Forward Current Index**

Symbol	Description
Z6	I <sub>F</sub> :60mA

Example:  
 45-21S/KK2C-H3030L9N32733Z6/2T(SW)

CRI	80(Min.)
CCT	3000K
Flux	18~27lm
V <sub>F</sub>	2.7~3.3V
I <sub>F</sub>	60mA

## Mass Production List

Product	CRI Min. (1)	CCT(K)	Φ(lm) Min. (2)	Φ(lm) Max. (2)
45-21S/KK2C-H3030L9N32733Z6/2T(SW)	80	3000K	18	27
45-21S/KK2C-H4040M3N42733Z6/2T(SW)	80	4000K	19	33
45-21S/KK2C-H6565M3N42733Z6/2T(SW)	80	6500K	19	33
45-21S/KK2C-H3030L8M32733Z6/2T(SW)	80	3000K	17	21
45-21S/KK2C-H4040L9M32733Z6/2T(SW)	80	4000K	18	21
45-21S/KK2C-H6565L9M32733Z6/2T(SW)	80	6500K	18	21

Note:

1. Tolerance of Color Rendering Index:  $\pm 2$
2. Tolerance of Luminous flux:  $\pm 11\%$ .

EVERLIGHT

## Device Selection Guide

Chip Materials	Emitted Color	Resin Color
InGaN	Cool White Natural White Warm White	Water Clear

## Absolute Maximum Ratings (T<sub>Soldering</sub>=25°C)

Parameter	Symbol	Rating	Unit
Forward Current	I <sub>F</sub>	75	mA
Peak Forward Current (Duty 1/10 @10ms)	I <sub>FP</sub>	100	mA
Power Dissipation	P <sub>d</sub>	250	mW
Operating Temperature	T <sub>opr</sub>	-40 ~ +85	°C
Storage Temperature	T <sub>stg</sub>	-40 ~ +100	°C
Thermal Resistance (Junction / Soldering point)	R <sub>th J-S</sub>	50	°C/W
Junction Temperature	T <sub>j</sub>	125	°C
Soldering Temperature	T <sub>sol</sub>	Reflow Soldering : 260 °C for 10 sec. Hand Soldering : 350 °C for 3 sec.	

Note:

The products are sensitive to static electricity and must be carefully taken when handling products

## Electro-Optical Characteristics (T<sub>Soldering</sub>=25°C)

Parameter	Symbol	Min.	Typ.	Max.	Unit	Condition
Luminous Flux <sub>(1)</sub>	Φ	17	-----	33	lm	I <sub>F</sub> =60mA
Forward Voltage <sub>(2)</sub>	V <sub>F</sub>	2.7	-----	3.3	V	I <sub>F</sub> =60mA
Color Rendering Index <sub>(3)</sub>	Ra	80	-----	-----		I <sub>F</sub> =60mA
Viewing Angle	2θ <sub>1/2</sub>	-----	120	-----	deg	I <sub>F</sub> =60mA
Reverse Current	I <sub>R</sub>	-----	-----	50	μA	V <sub>R</sub> =5V

Notes:

1. Tolerance of Luminous flux: ±11%.
2. Tolerance of Forward Voltage : ±0.1V.
3. Tolerance of Color Rendering Index: ±2

### Bin Range of Luminous Flux

Bin Code	Min.	Max.	Unit	Condition
L8	17	18	lm	$I_F=60\text{mA}$
L9	18	19		
M3	19	21		
M4	21	24		
N3	24	27		
N4	27	33		

Note:  
 Tolerance of Luminous flux:  $\pm 11\%$ .

### Bin Range of Forward Voltage

Group	Bin Code	Min.	Max.	Unit	Condition
2733	34	2.7	2.8	V	$I_F=60\text{mA}$
	35	2.8	2.9		
	36	2.9	3.0		
	37	3.0	3.1		
	38	3.1	3.2		
	39	3.2	3.3		

Note:  
 Tolerance of Forward Voltage:  $\pm 0.1\text{V}$ .

The C.I.E. 1931 Chromaticity Diagram

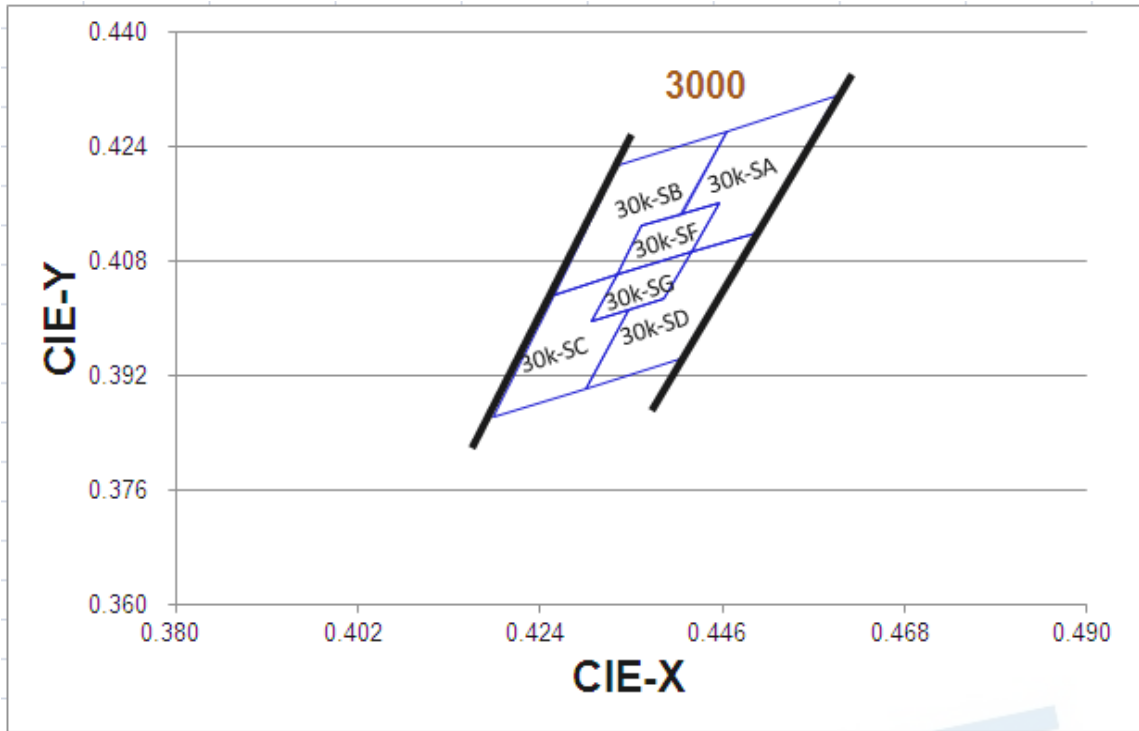

Bin Range of Chromaticity Coordinates

CCT	Bin Code	CIE_x	CIE_y	Bin Code	CIE_x	CIE_y	
3000K	30K-SA	0.4597	0.4309	30K-SD	0.4500	0.4120	
		0.4465	0.4261		0.4423	0.4092	
		0.4410	0.4145		0.4390	0.4026	
		0.4457	0.4162		0.4346	0.4011	
		0.4423	0.4092		0.4294	0.3902	
		0.4500	0.4120		0.4408	0.3942	
	Reference Range:2850K~3010K						
	30K-SB	0.4465	0.4261	30K-SC	0.4256	0.4033	
		0.4334	0.4214		0.4182	0.3863	
		0.4256	0.4033		0.4294	0.3902	
		0.4332	0.4060		0.4346	0.4011	
		0.4363	0.4128		0.4302	0.3995	
		0.4410	0.4145		0.4332	0.4060	
	Reference Range:3000K~3200K						
	30K-SF	0.4457	0.4162	30K-SG	0.4423	0.4092	
		0.4363	0.4128		0.4332	0.4060	
		0.4332	0.4060		0.4302	0.3995	
		0.4423	0.4092		0.4390	0.4026	
Reference Range:2940K~3060K							

**The C.I.E. 1931 Chromaticity Diagram**

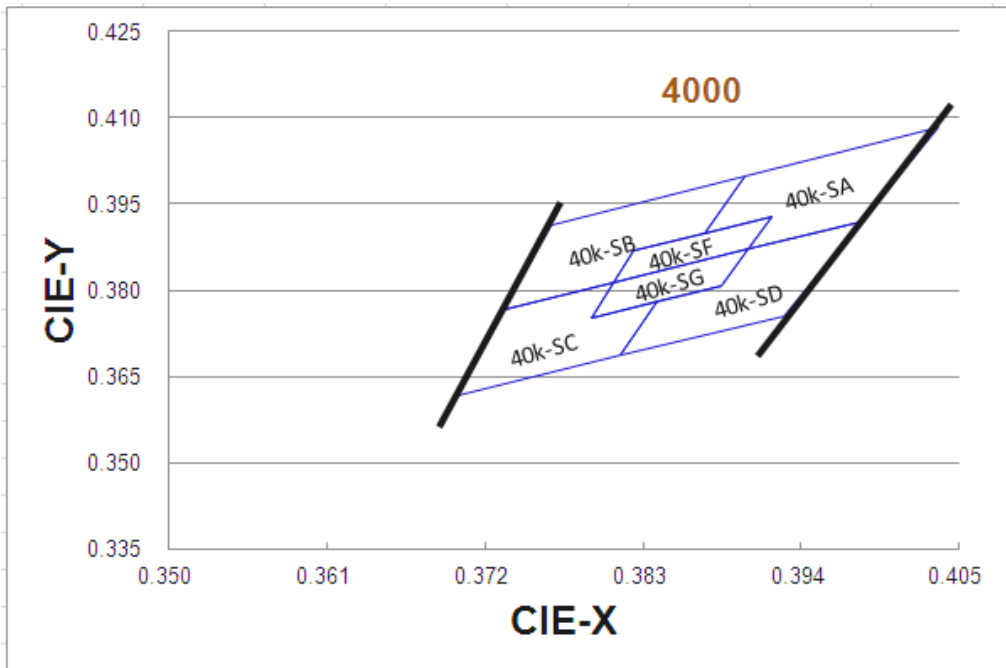

**Bin Range of Chromaticity Coordinates**

CCT	Bin Code	CIE_x	CIE_y	Bin Code	CIE_x	CIE_y	
4000K	40K-SA	0.4036	0.4084	40K-SD	0.3982	0.3920	
		0.3901	0.3999		0.3903	0.3871	
		0.3873	0.3898		0.3884	0.3808	
		0.3920	0.3927		0.3840	0.3781	
		0.3903	0.3871		0.3814	0.3687	
		0.3982	0.3920		0.3928	0.3756	
	Reference Range:3670K~3920K						
	40K-SB	0.3901	0.3999	40K-SC	0.3733	0.3766	
		0.3766	0.3914		0.3700	0.3618	
		0.3733	0.3766		0.3814	0.3687	
		0.3809	0.3813		0.3840	0.3781	
		0.3823	0.3868		0.3794	0.3753	
0.3873		0.3898	0.3809		0.3813		
Reference Range:3920K~4200K							
40K-SF	0.3920	0.3927	40K-SG	0.3903	0.3871		
	0.3823	0.3868		0.3809	0.3813		
	0.3809	0.3813		0.3794	0.3753		
	0.3903	0.3871		0.3884	0.3808		
Reference Range:3820K~4030K							

The C.I.E. 1931 Chromaticity Diagram

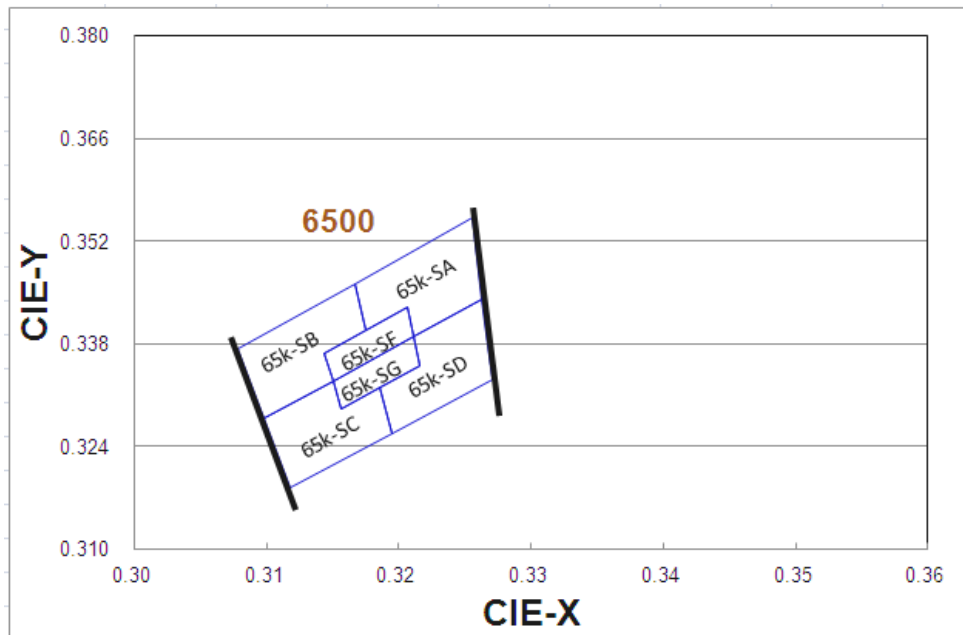

Bin Range of Chromaticity Coordinates

CCT	Bin Code	CIE_x	CIE_y	Bin Code	CIE_x	CIE_y	
6500K	65K-SA	0.3255	0.3551	65K-SD	0.3263	0.3441	
		0.3167	0.3463		0.3211	0.3390	
		0.3175	0.3398		0.3216	0.3351	
		0.3207	0.3430		0.3186	0.3321	
		0.3211	0.3390		0.3195	0.3257	
		0.3263	0.3441		0.3271	0.3331	
	Reference Range:5770K~6200K						
	65K-SB	0.3167	0.3463	65K-SC	0.3098	0.3279	
		0.3078	0.3374		0.3118	0.3183	
		0.3098	0.3279		0.3195	0.3257	
		0.3150	0.3329		0.3186	0.3321	
		0.3143	0.3367		0.3156	0.3292	
0.3175		0.3398	0.3150		0.3329		
Reference Range:6200K~6700K							
65K-SF	0.3207	0.3430	65K-SG	0.3211	0.3390		
	0.3143	0.3367		0.3150	0.3329		
	0.3150	0.3329		0.3156	0.3292		
	0.3211	0.3390		0.3216	0.3351		
Reference Range:6020K~6370K							

Note:

1. The value is based on driving current by 60mA.
2. Tolerance of Chromaticity Coordinates: ±0.01.



Spectrum Distribution

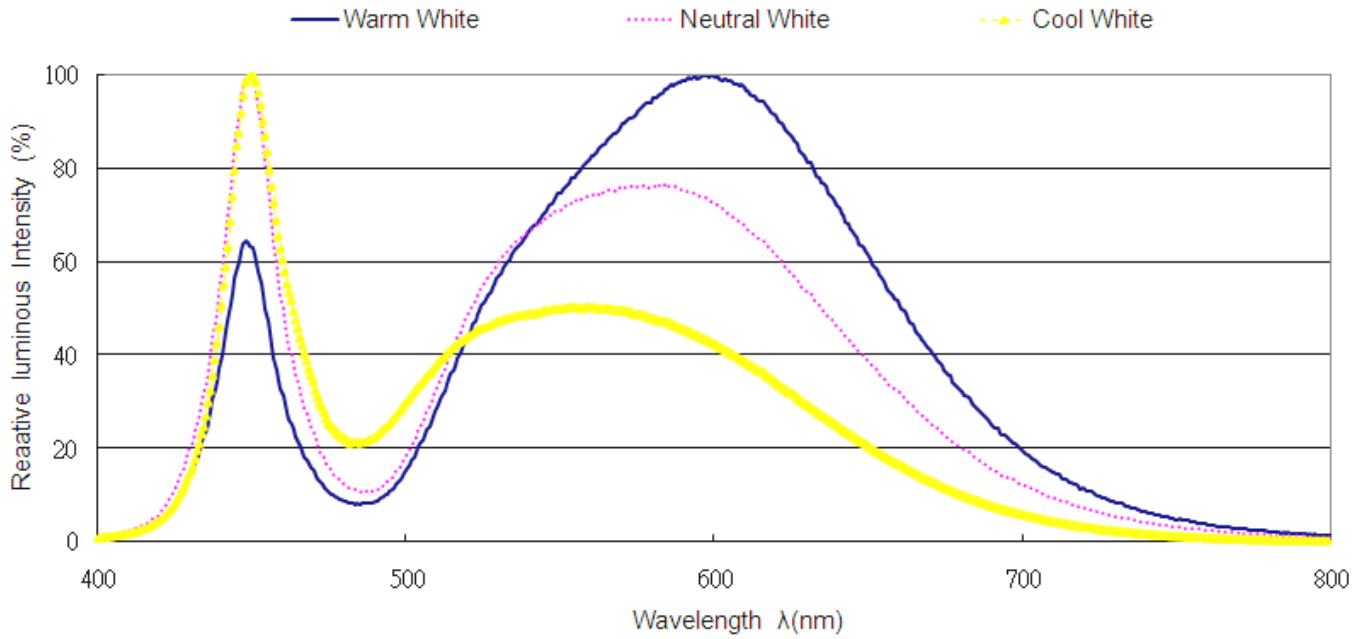

Typical Electro-Optical Characteristics Curves

Fig.1 – Forward Voltage Shift vs. Junction Temperature

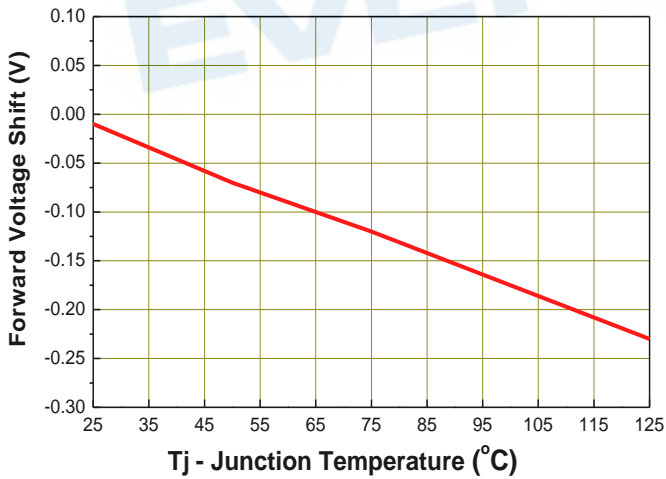

Fig.2 - Relative Luminous Intensity vs. Forward Current

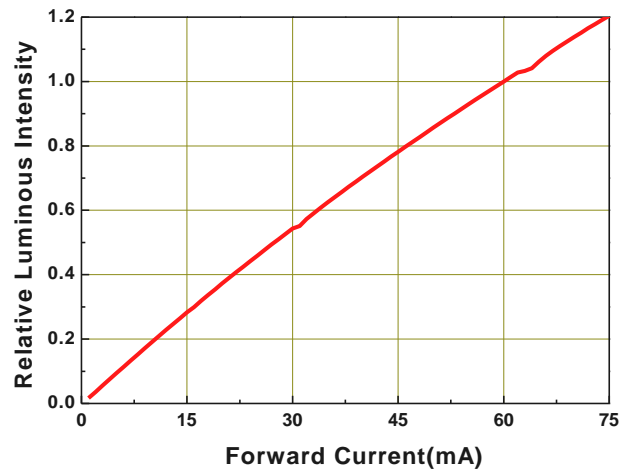

Fig.3 - Relative Luminous Intensity vs. Junction Temperature

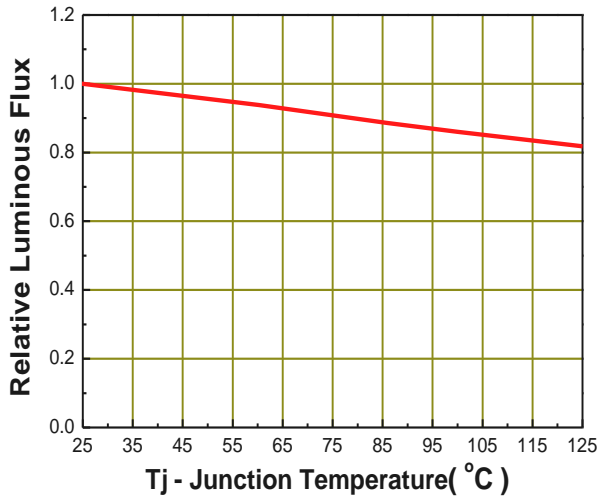

Fig.4 - Forward Current vs. Forward Voltage

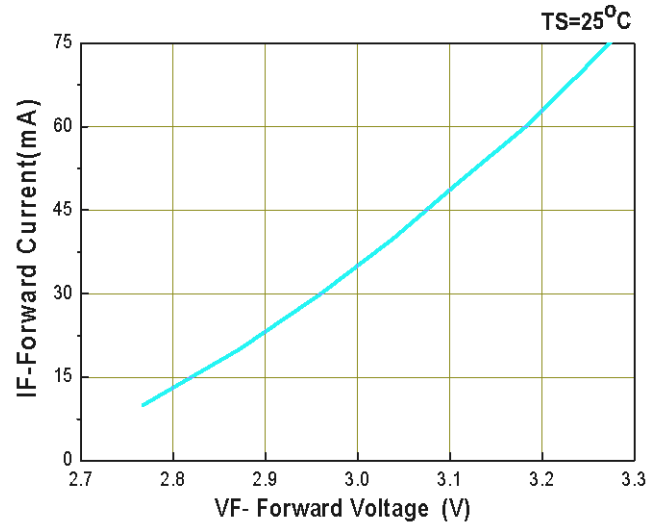

Fig.5 - Max. Driving Forward Current vs. Soldering Temperature

$R_{th\ j-s} = 50\ ^\circ\text{C/W}$

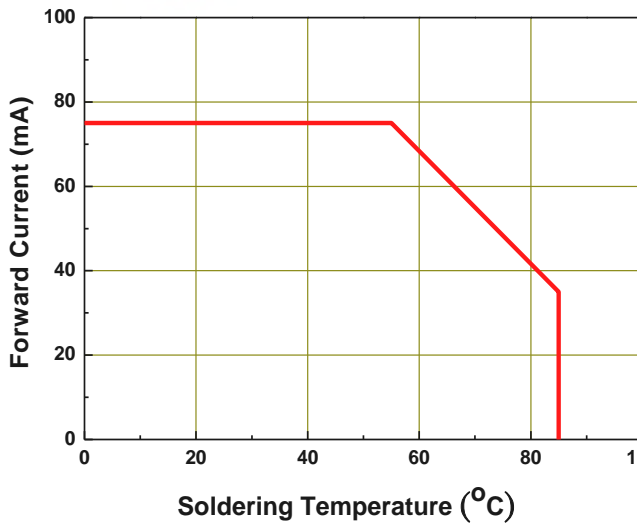
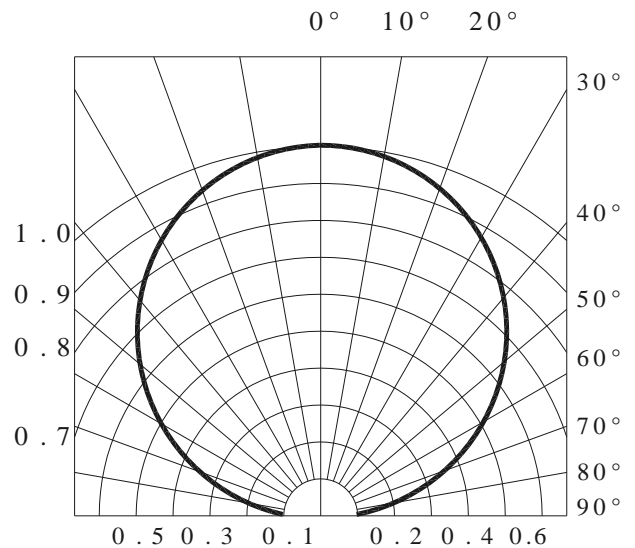
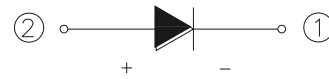
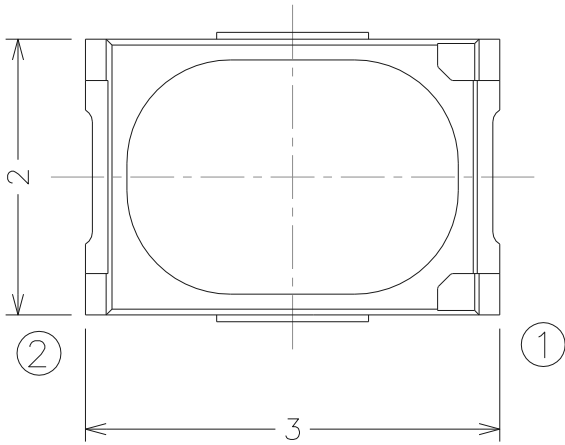

Fig.6 - Radiation Diagram



**Package Dimension**



Polarity

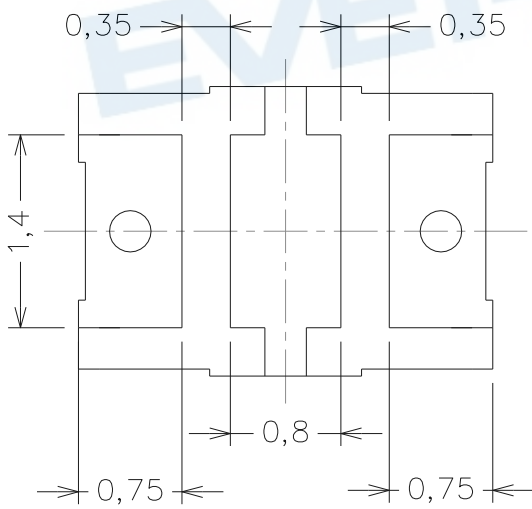
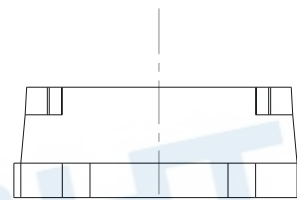
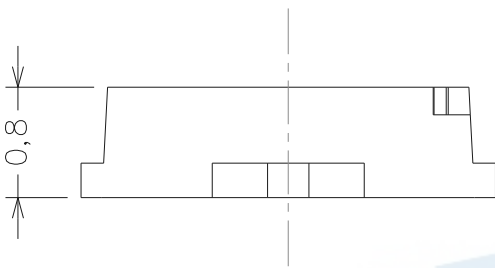

Bot. view

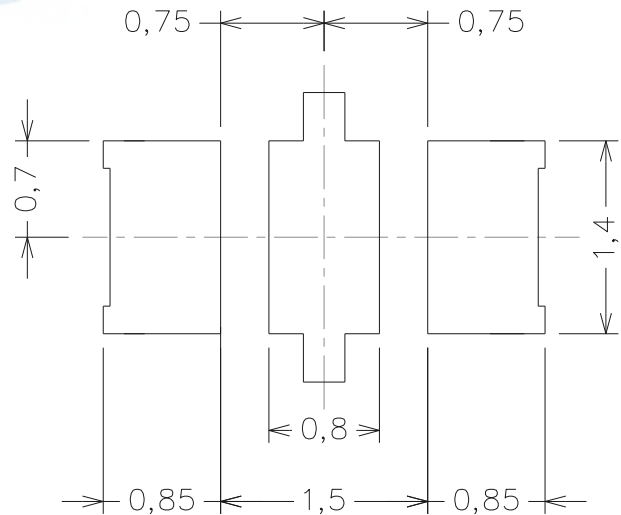

Soldering patterns

Note:  
 Tolerance unless mentioned is  $\pm 0.2$ mm; Unit = mm

**Moisture Resistant Packing Materials**

**Label Explanation**



- CPN: Customer's Product Number
- P/N: Product Number
- QTY: Packing Quantity
- CAT: Luminous Intensity Rank
- HUE: Dom. Wavelength Rank
- REF: Forward Voltage Rank
- LOT No: Lot Number

**Reel Dimensions**

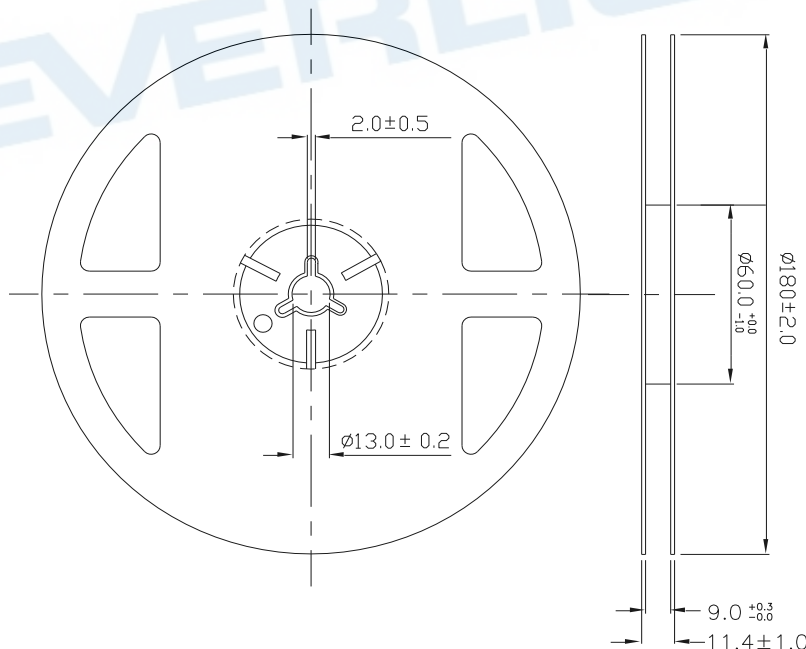

Note:  
 Tolerances unless mentioned  $\pm 0.1$ mm. Unit = mm

**Carrier Tape Dimensions: Loaded Quantity 250 /500/1000/2000 pcs. Per Reel**

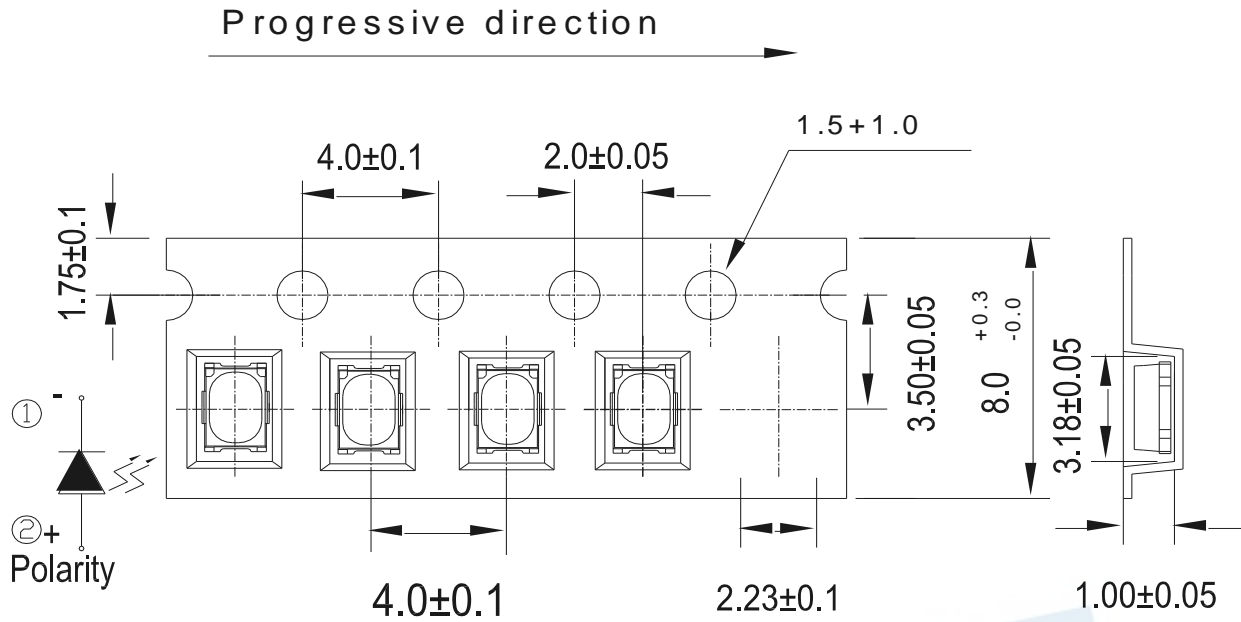

Note:  
 Tolerances unless mentioned  $\pm 0.1$ mm. Unit = mm

**Moisture Resistant Packing Process**

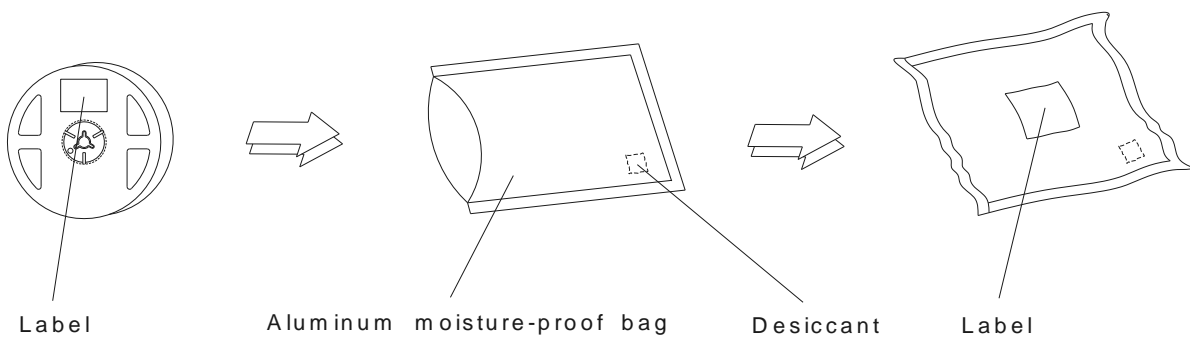

## Reliability Test Items and Conditions

The reliability of products shall be satisfied with items listed below.

Confidence level : 90%

LTPD : 10%

No.	Items	Test Condition	Test Hours/Cycles	Sample Size	Ac/Re
1	Reflow Soldering	Temp. : 260°C/10sec.	6 Min.	22 PCS.	0/1
2	Thermal Shock	H : +100°C 20min $\int$ 10 sec L : -10°C 20min	200 Cycles	22 PCS.	0/1
3	Temperature Cycle	H : +100°C 30min $\int$ 5 min L : -40°C 30min	200 Cycles	22 PCS.	0/1
4	High Temperature/Humidity Reverse Bias	Ta=85°C,85%RH	1000 Hrs.	22 PCS.	0/1
5	High Temperature/Humidity Operation	Ta=85°C,85%RH, I <sub>F</sub> = 40 mA	1000 Hrs.	22 PCS.	0/1
6	Low Temperature Storage	Ta=-40°C	1000 Hrs.	22 PCS.	0/1
7	High Temperature Storage	Ta=85°C	1000 Hrs.	22 PCS.	0/1
8	Low Temperature Operation Life	Ta=-40°C, I <sub>F</sub> = 75 mA	1000 Hrs.	22 PCS.	0/1
9	High Temperature Operation/ Life#1	Ta=25°C, I <sub>F</sub> = 75 mA	1000 Hrs.	22 PCS.	0/1
10	High Temperature Operation/ Life#2	Ta=55°C, I <sub>F</sub> =75 mA	1000 Hrs.	22 PCS.	0/1
11	High Temperature Operation/ Life#3	Ta=85°C, I <sub>F</sub> = 40 mA	1000 Hrs.	22 PCS.	0/1

## Precautions for Use

### 1. Over-current-proof

Customer must apply resistors for protection; otherwise slight voltage shift will cause big current change (Burn out will happen).

### 2. Storage

2.1 Do not open moisture proof bag before the products are ready to use.

2.2 Before opening the package: The LEDs should be kept at 30°C or less and 90%RH or less.

2.3 After opening the package: The LED's floor life is 168 Hrs under 30°C or less and 60% RH or less. If unused LEDs remain, it should be stored in moisture proof packages.

2.4 If the moisture absorbent material (silica gel) has faded away or the LEDs have exceeded the storage time, baking treatment should be performed using the following conditions.

Baking treatment: 60±5°C for 24 hours.

### 3. Soldering Condition

#### 3.1 Pb-free solder temperature profile

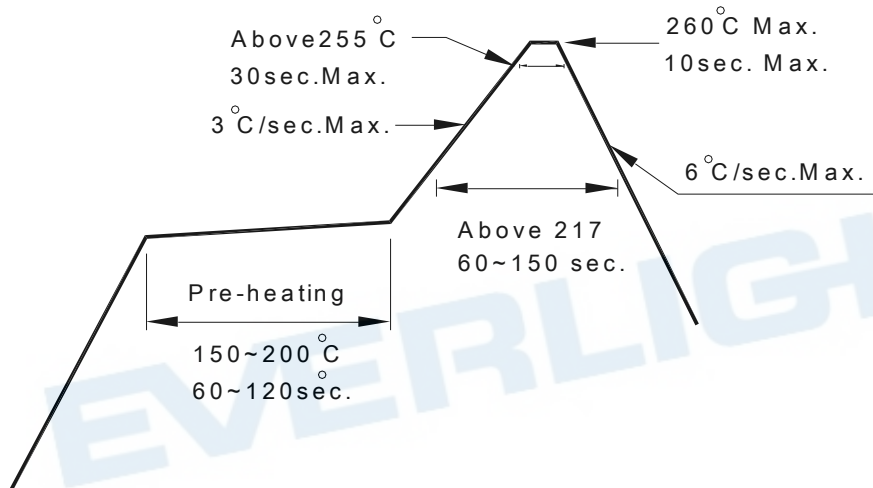

3.2 Reflow soldering should not be done more than two times.

3.3 When soldering, do not put stress on the LEDs during heating.

3.4 After soldering, do not warp the circuit board.

#### 4. Soldering Iron

Each terminal is to go to the tip of soldering iron temperature less than 350°C for 3 seconds within once in less than the soldering iron capacity 25W. Leave two seconds and more intervals, and do soldering of each terminal. Be careful because the damage of the product is often started at the time of the hand solder.

#### 5. Repairing

Repair should not be done after the LEDs have been soldered. When repairing is unavoidable, a double-head soldering iron should be used (as below figure). It should be confirmed beforehand whether the characteristics of the LEDs will or will not be damaged by repairing.

