

PRODUCT SPECIFICATION

新弘智

SPEC. NO: T-0602-141E

DATE: Mar.14,2019

CUSTOMER'S PRODUCT NAME:

EMTEK PRODUCT NAME:

CMF4532F-SERIES-Tms

THIS SPECIFICATION IS:

- FULLY ACCEPTED
 DENIED
 ACCEPTED UNDER THE FOLLOWING CONDITIONS



SIGNATURE: _____ DATE: _____

NAME(PRINT): _____

TITLE: _____

 **EMTEK CO., LTD.**

FACTORY:
39,Chingao Rd.,(305)Hsinpu,
Hsinchu Hsien,Taiwan,R.O.C
TEL: 03-5894-433
FAX: 03-5894-523

本文件內容全部或部份,未經兆欣科技股份有限公司同意不得以任何形式複製或其他用途
All rights reserved.This document or parts thereof,may not be reproduced by any means or used in any manner without written permission of EMTEK CO.,LTD.

PRODUCT SPECIFICATION

SPEC. NO.

T-0602-141E



1. Scope

This specification applies ferrite Chip common mode filters CMF4532F-Series-Tms to be delivered to user.

2. Product Identification

CMF 4532 F - 600 - 2P - Tms

(1) (2) (3) (4) (5) (6)

- (1) Product name
- (2) Shapes and dimensions
- (3) Shielding Type
- (4) Impedance 【 at 100MHz 】
600:60Ω
- (5) Number of Line
2P:2-Line
- (6) For Customer Design

3. Shapes and Dimensions [Dimensions in mm]

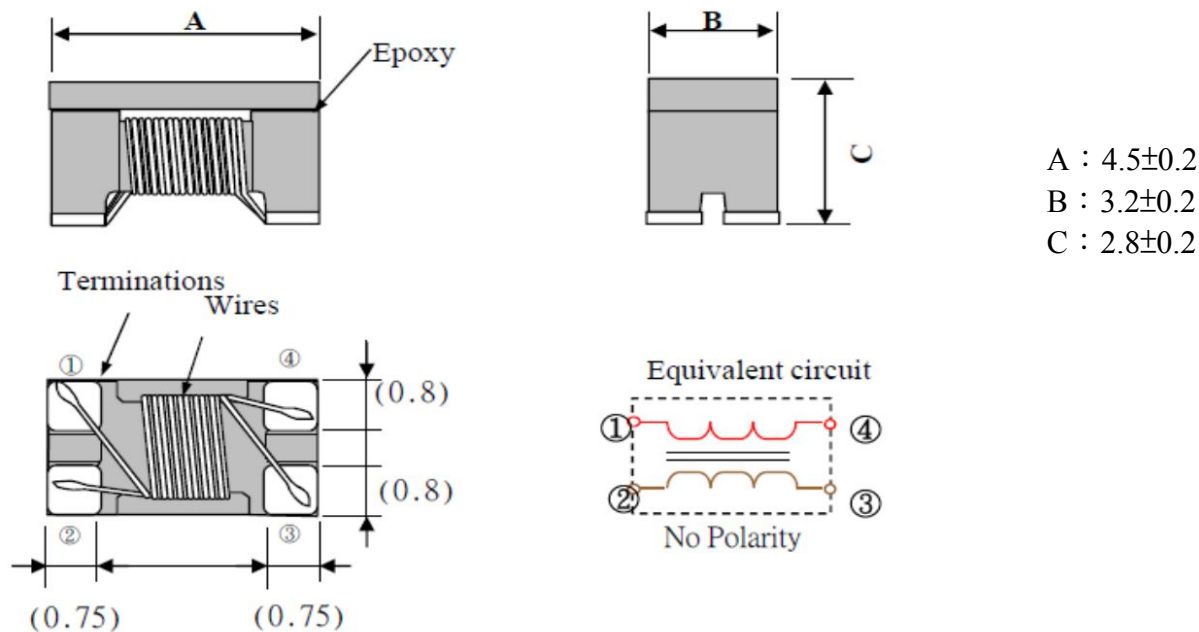

Drawn by	Checked by	Approved by
Cindy Dec. 1. 2016	Zheng Dec. 1. 2016	Su Dec 1. 2016

PRODUCT SPECIFICATION

SPEC. NO.

T-0602-141E



4. Electrical Characteristics

4-1 Electrical Spec.

Our Product Part Number	Common-Mode Impedance Z(Ω) at 100MHz	Common-Mode Inductance uH at 100KHz	DC Resistance Rdc(Ω) Max.	Rated Current Idc(A) Max.	Rated Voltage Vdc(V)	Withstanding Voltage Vdc(V)	Insulation Resistance (M Ω)Min.
CMF4532F-600-2P-Tms	60 \pm 25%		0.05	2.0	50	125	10
CMF4532F-900-2P-Tms	90 \pm 25%		0.05	2.0	50	125	10
CMF4532F-161-2P-Tms	160 \pm 25%		0.08	2.0	50	125	10
CMF4532F-231-2P-Tms	230 \pm 25%		0.10	1.8	50	125	10
CMF4532F-421-2P-Tms	420 \pm 25%		0.10	1.6	50	125	10
CMF4532F-601-2P-Tms	600 \pm 25%	2.0 \pm 50%	0.07	2.8	50	125	10

Rated Current Idc : DC current (A) that will cause an approximate ΔT of 40°C

4-2 Characteristics (Reference)

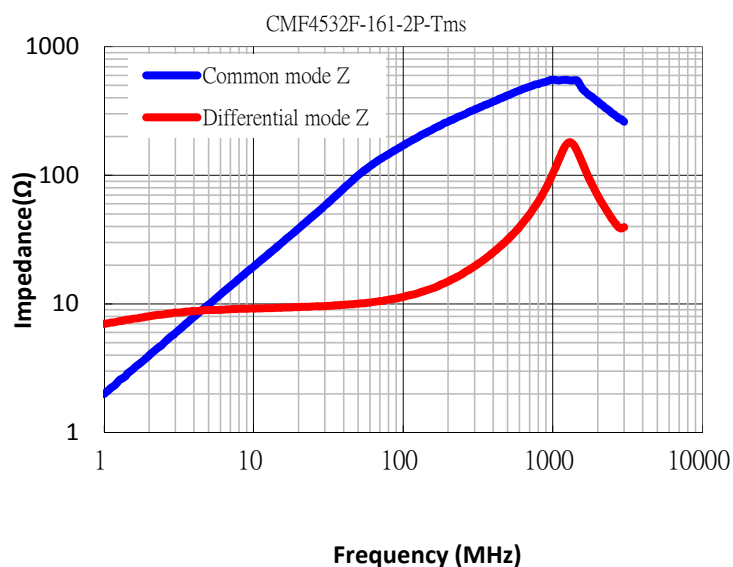
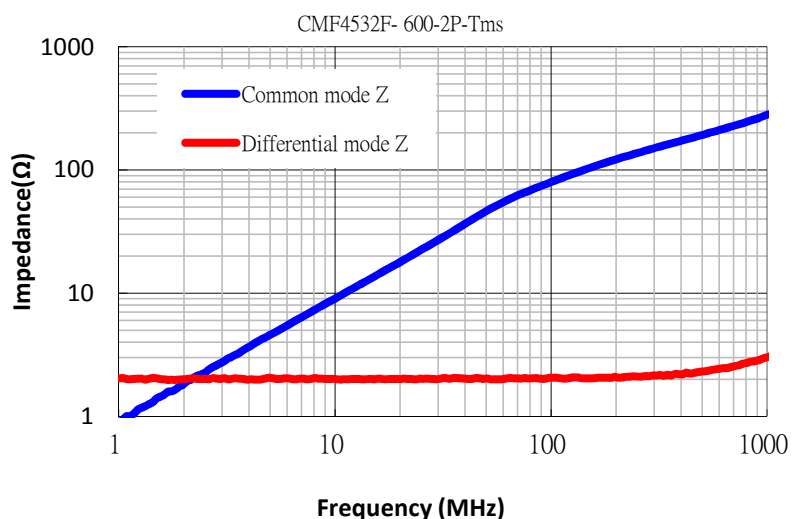

PRODUCT SPECIFICATION

SPEC. NO.

T-0602-141E



4-2 Characteristics (Reference)

CMF4532F-421-2P-Tms

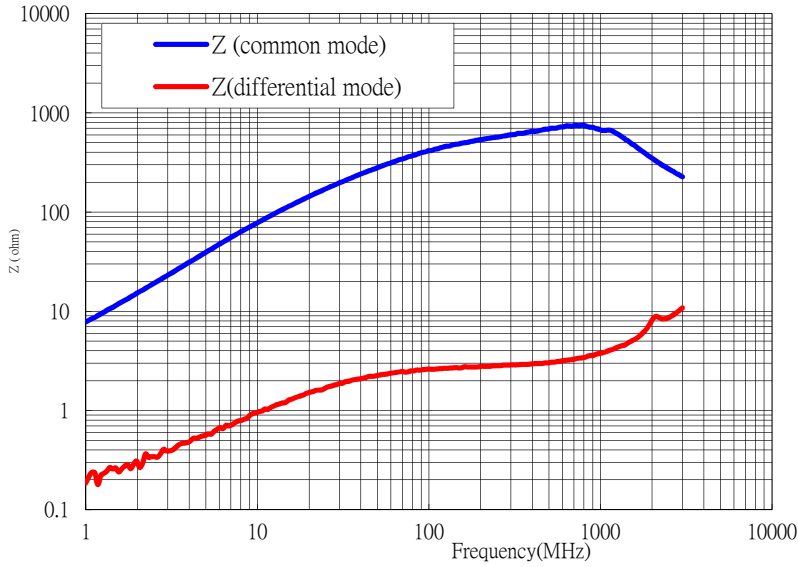

CMF4532F-601-2P-Tms

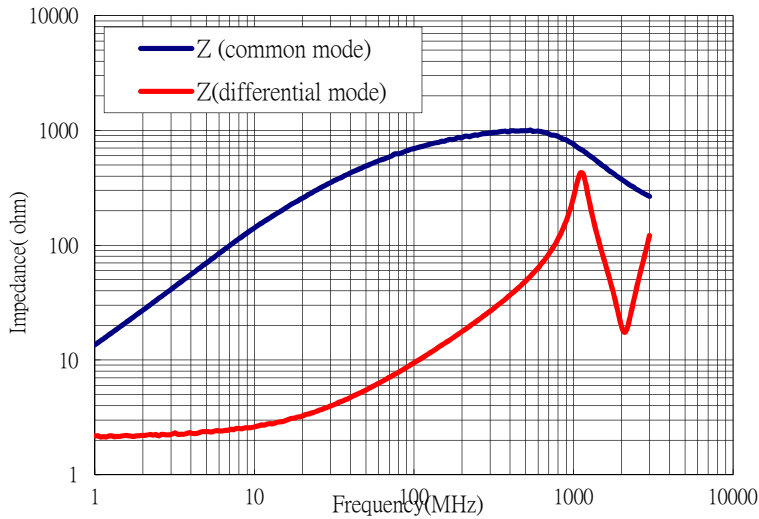

PRODUCT SPECIFICATION

SPEC. NO.

T-0602-141E



4-3 Test Equipment

4-3-1 Impedance

Measured by using Agilent E4991A RF Impedance Analyzer.

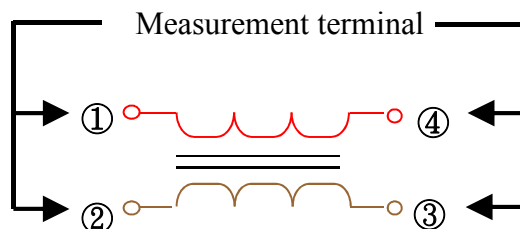

4-3-2 DC Resistance

Measured by using Chroma 16502 mill ohm meter.

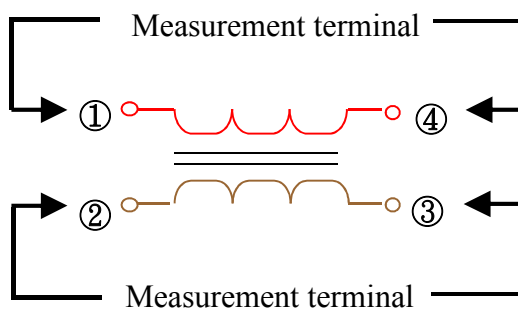

4-3-3 Insulation Resistance

Measured by using Chroma 19073

Measurement voltage : 50v, Measurement time: 60 sec.

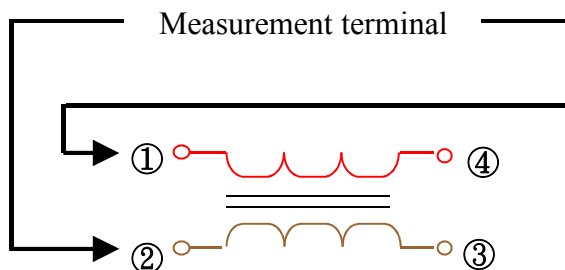

PRODUCT SPECIFICATION

SPEC. NO.

T-0602-141E

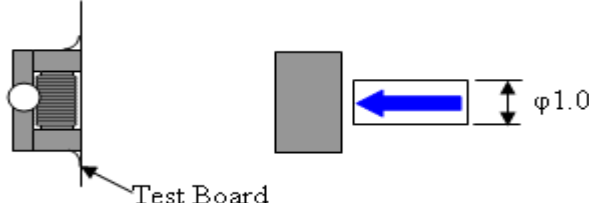
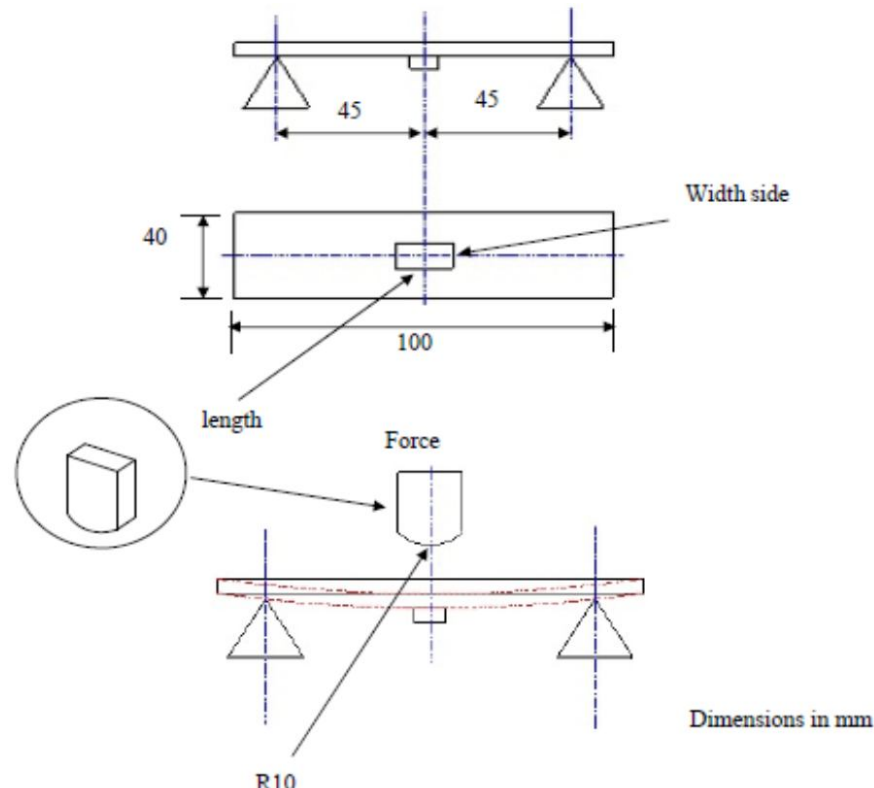

5. Reliability Test

Operating temperature : -40 to +125°C		Storage temp and humidity : -40 to 85°C, 70%RH max.
Item	Specifications	Test conditions
Solder-ability	It can be connected on the Recommendation soldering condition.	Apply cream solder to the test circuit board . It is mounted on the recommendation soldering condition.
Terminal strength	The terminal electrode and the ferrite must not be dam 160±25%	Solder a chip to test substrate, and then laterally apply a load 1.8Kg in the arrow direction. 
Strength on pc board bending	The terminal electrode and the ferrite must not be damaged.	Soldering a chip to a test substrate , bend the substrate by 2mm and then return.  Dimensions in mm Test board : Glass base epoxy multiplayer board pc board pattern. PC board pattern : Recommended PC board pattern.

PRODUCT SPECIFICATION

SPEC. NO.

T-0602-141E

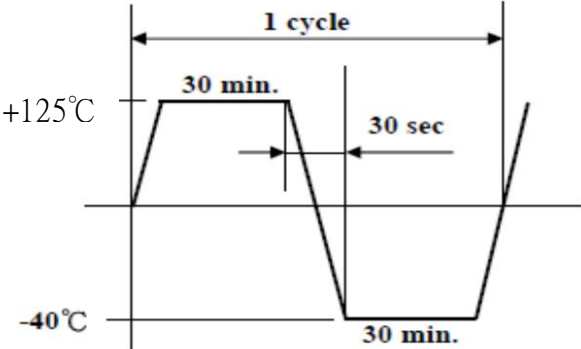

Item	Specifications	Test conditions
High temperature resistance	Appearance : Ferrite shall not be damaged. Impedance: Within $\pm 20\%$ of the initial value. insulation resistance: $>10(M\Omega)$ DC resistance : standard value	Temperature : $+125\pm 2^{\circ}C$ Applied voltage : Rated voltage Applied current : Rated current Testing time : 500 ± 12 hours Measurement : After placing for 24 hours min.
Humidity resistance	inside.	Temperature : $+85\pm 2^{\circ}C$ Humidity : 90 to 95%RH Applied current : Rated current Applied voltage : Rated voltage Testing time : 500 ± 12 hours Measurement : After placing for 24 hours min.
Thermal cycle		Temperature : $-40^{\circ}C, +125^{\circ}C$ kept stabilized for 30 minutes each. Cycle : 100 cycle Measurement : After placing for 24 hours min. <div style="text-align: center;">  </div>
Low temperature resistance		Temperature : $-40\pm 2^{\circ}C$ Testing time : 500 ± 12 hours Measurement : After placing for 24 hours min.
Vibration	Appearance : Ferrite shall not be damaged.	Frequency : 10 to 50 Hz Amplitude : 1.52 mm Dimension and times : X ,Y and Z directions for 2 hours each.

PRODUCT SPECIFICATION

SPEC. NO.

T-0602-141E



6. Packaging

The packaging must be done not to receive any damage during transporting and storing

6-1 Tape dimensions

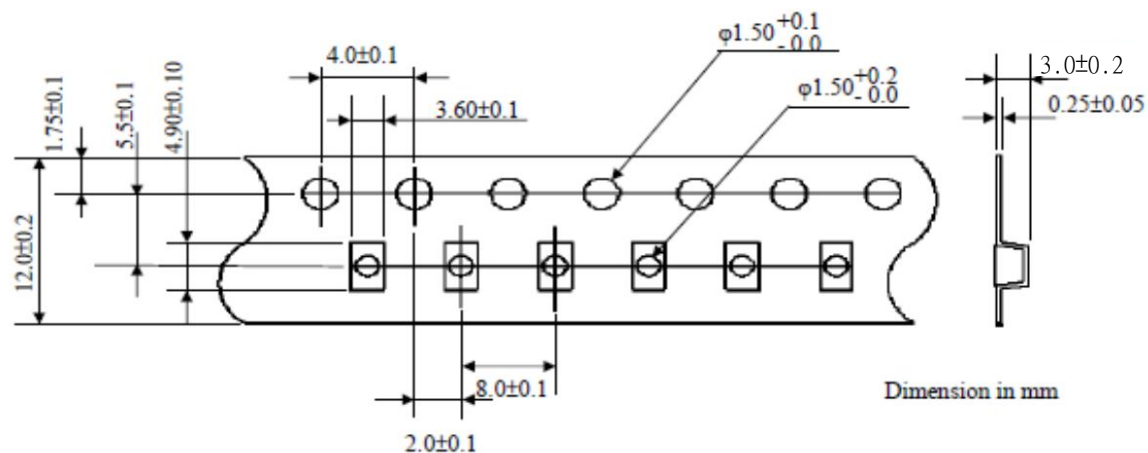

6-2 Reel dimensions

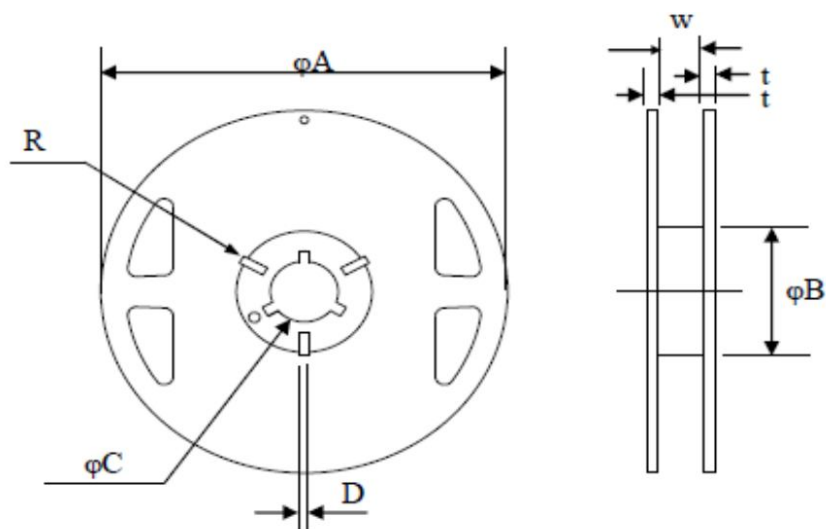

(Dimensions in mm)

Symbol	T
ϕA	180+0,-3
ϕB	60+1, -0
ϕC	13±0.2
D	2.2±0.5
W	12.0±0.3
t	1.2
R	1

6-3 Tapping figure

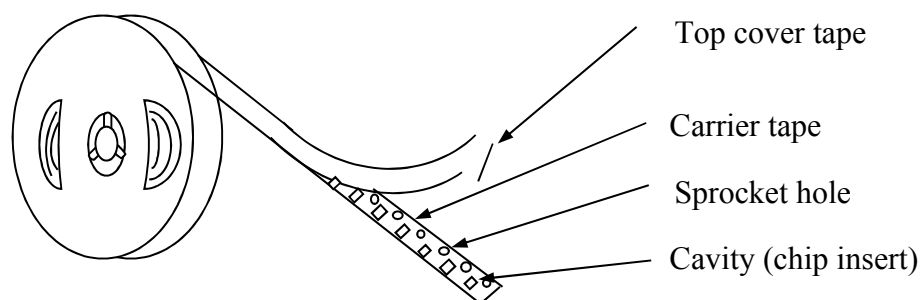

PRODUCT SPECIFICATION

SPEC. NO.

T-0602-141E



6-4 Packaging Form

There shall not continuation more than two vacancies of the product.

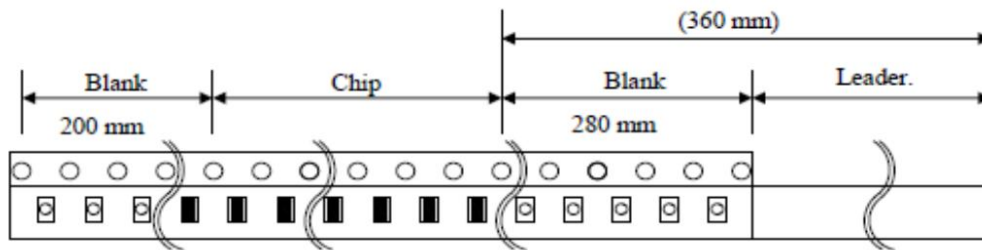

Material of carrier tape : Polystyrene

Material of cover tape : Polyester

6-5 Cover Tape Peel Strength

The force for tearing off cover tape is 0.05~0.69(N) in the arrow direction at the following conditions:

Temperature : 5 ~ 35°C

Humidity : 45 ~ 85%

Atmospheric pressure : 860 ~ 1060 hpa

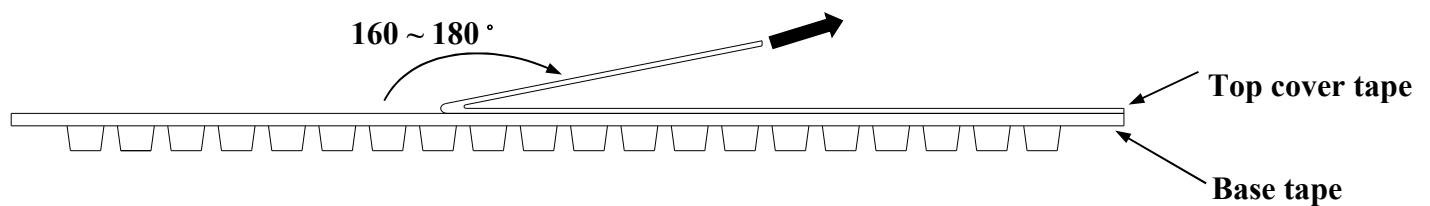

6-6 Packing Quantity

φ180 mm reel T type : 500 pcs./reel

PRODUCT SPECIFICATION

SPEC. NO.

T-0602-141E



7. Recommended Soldering Conditions (Please use this product by reflow soldering)

7-1 Recommended Footprint

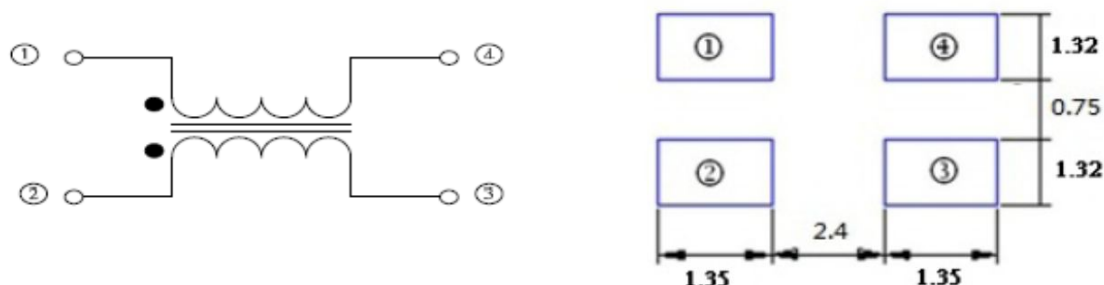

7-2 Recommended Reflow Pattern

Reflow: until two times

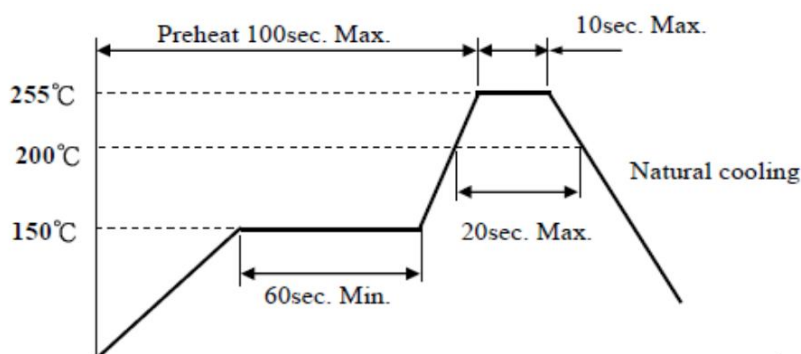

7-3 Iron Soldering

Use a solder iron of less than 30W when soldering, do not allow the soldering iron tip directly touch the ferrite body outside fo terminal electrode.

2 seconds max. at 280°C.

8. Attention in Case of Using

In case of using product, please avoid following matters:

- Splashing water or salt water
- Dew condenses
- Toxic gas (Hydrogen sulfide, Sulfurous acid, Chlorine, Ammonia)
- Vibrations or shocks which exceed the specified condition

Please be careful for the stress to this product by board flexure or something after the mounting.

*Recommended wire wound inductors should be used within 6 months from the time of delivery.