

Features

- Epitaxial Planar Die Construction
- Complementary PNP Type Available (DXTA92)
- Ideally Suited for Automated Assembly Processes
- Ideal for Medium Power Switching or Amplification Applications
- **Lead Free By Design/RoHS Compliant (Note 1)**
- **"Green" Device (Note 2)**

Mechanical Data

- Case: SOT89-3L
- Case Material: Molded Plastic, "Green" Molding Compound. UL Flammability Classification Rating 94V-0
- Moisture Sensitivity: Level 1 per J-STD-020C
- Terminals: Finish — Matte Tin annealed over Copper leadframe (Lead Free Plating). Solderable per MIL-STD-202, Method 208
- Marking & Type Code Information: See Page 3
- Ordering Information: See Page 3
- Weight: 54.8mg (approximate)

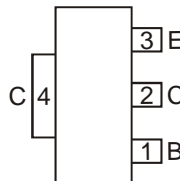
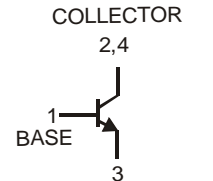

Top View

 TOP VIEW
Device Schematic

Pin Out Configuration

Maximum Ratings @ $T_A = 25^\circ\text{C}$ unless otherwise specified

Characteristic	Symbol	Value	Unit
Collector-Base Voltage	V_{CB0}	300	V
Collector-Emitter Voltage	V_{CE0}	300	V
Emitter-Base Voltage	V_{EB0}	6	V
Continuous Collector Current	I_C	500	mA

Thermal Characteristics

Characteristic	Symbol	Value	Unit
Power Dissipation (Note 3) @ $T_A = 25^\circ\text{C}$	P_D	1	W
Thermal Resistance, Junction to Ambient (Note 3)	$R_{\theta JA}$	125	$^\circ\text{C/W}$
Operating and Storage Temperature Range	T_J, T_{STG}	-55 to +150	$^\circ\text{C}$

Electrical Characteristics @ $T_A = 25^\circ\text{C}$ unless otherwise specified

Characteristic	Symbol	Min	Typ	Max	Unit	Test Conditions
OFF CHARACTERISTICS (Note 4)						
Collector-Base Breakdown Voltage	$V_{(BR)CBO}$	300	—	—	V	$I_C = 100\mu\text{A}, I_E = 0$
Collector-Emitter Breakdown Voltage	$V_{(BR)CEO}$	300	—	—	V	$I_C = 1\text{mA}, I_B = 0$
Emitter-Base Breakdown Voltage	$V_{(BR)EBO}$	6	—	—	V	$I_E = 100\mu\text{A}, I_C = 0$
Collector Cut-off Current	I_{CBO}	—	—	0.1	μA	$V_{CB} = 200\text{V}, I_E = 0$
Emitter Cut-off Current	I_{EBO}	—	—	0.1	μA	$V_{EB} = 6\text{V}, I_C = 0$
ON CHARACTERISTICS (Note 4)						
Collector-Emitter Saturation Voltage	$V_{CE(SAT)}$	—	—	0.5	V	$I_C = 20\text{mA}, I_B = 2\text{mA}$
Base-Emitter Saturation Voltage	$V_{BE(SAT)}$	—	—	0.9	V	$I_C = 20\text{mA}, I_B = 2\text{mA}$
Static Forward Current Transfer Ratio	h_{FE}	25	—	—	—	$I_C = 1\text{mA}, V_{CE} = 10\text{V}$
		40				$I_C = 10\text{mA}, V_{CE} = 10\text{V}$
		40				$I_C = 30\text{mA}, V_{CE} = 10\text{V}$
SMALL SIGNAL CHARACTERISTICS						
Transition Frequency	f_T	50	—	—	MHz	$I_C = 10\text{mA}, V_{CE} = 20\text{V}, f = 100\text{MHz}$
Output Capacitance	C_{obo}	—	—	3	pF	$V_{CB} = 20\text{V}, f = 1\text{MHz}$

- Notes:
1. No purposefully added lead.
 2. Diodes Inc.'s "Green" policy can be found on our website at http://www.diodes.com/products/lead_free/index.php.
 3. Device mounted on FR-4 PCB; pad layout as shown on page 4 or in Diodes Inc. suggested pad layout document AP02001, which can be found on our website at <http://www.diodes.com/datasheets/ap02001.pdf>.
 4. Measured under pulsed conditions. Pulse width = 300 μs . Duty cycle $\leq 2\%$.

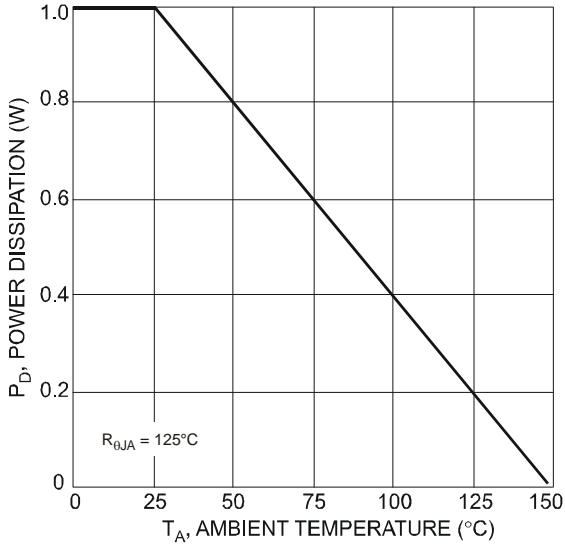

Fig. 1 Power Dissipation vs. Ambient Temperature (Note 3)

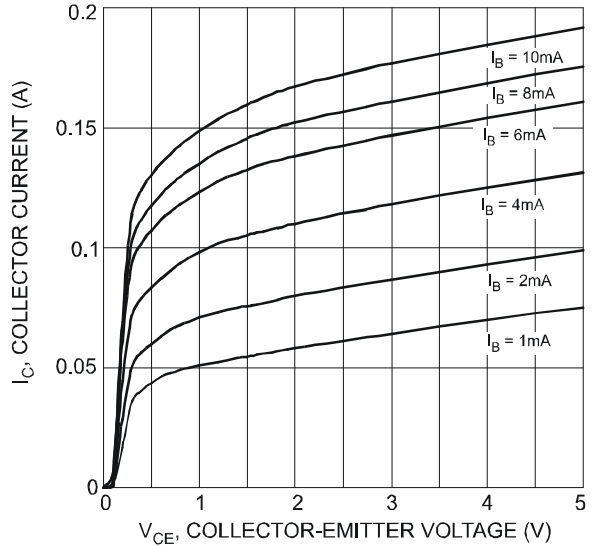

Fig. 2 Collector Current vs. Collector-Emitter Voltage

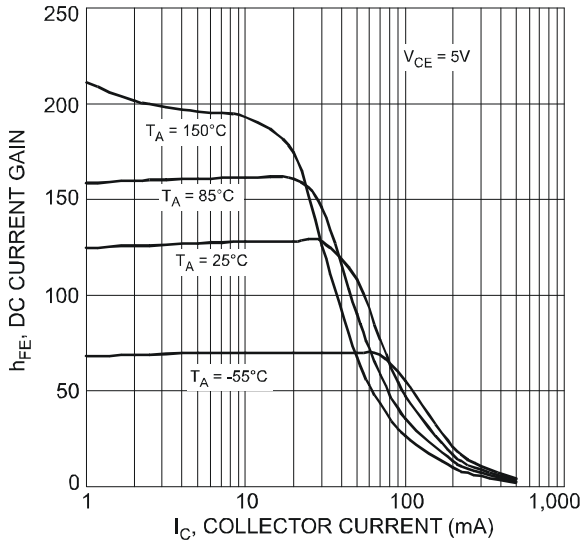

Fig. 3 Typical DC Current Gain vs. Collector Current

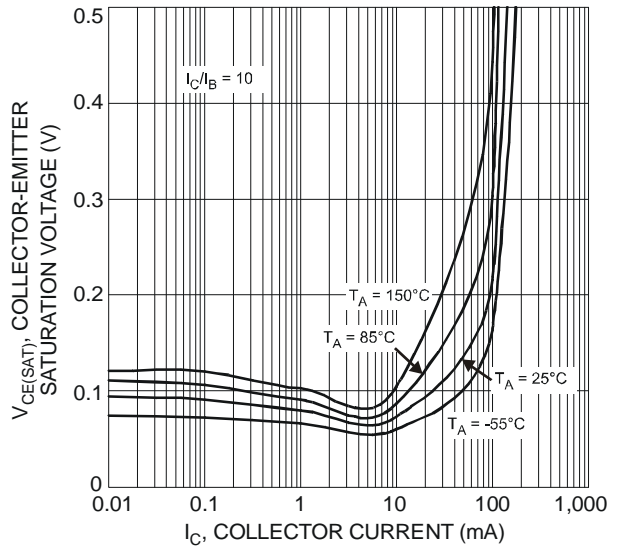

Fig. 4 Collector-Emitter Saturation Voltage vs. Collector Current

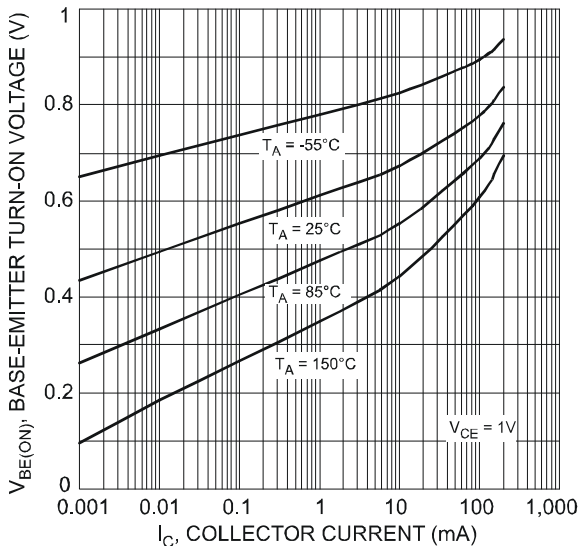

Fig. 5 Base-Emitter Turn-On Voltage vs. Collector Current

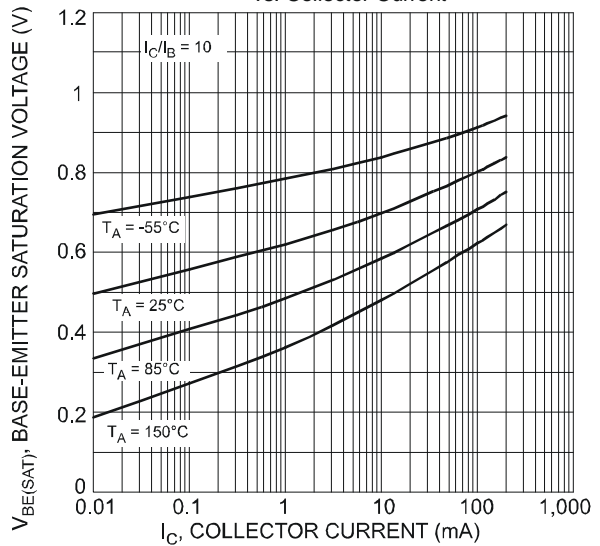

Fig. 6 Base-Emitter Saturation Voltage vs. Collector Current

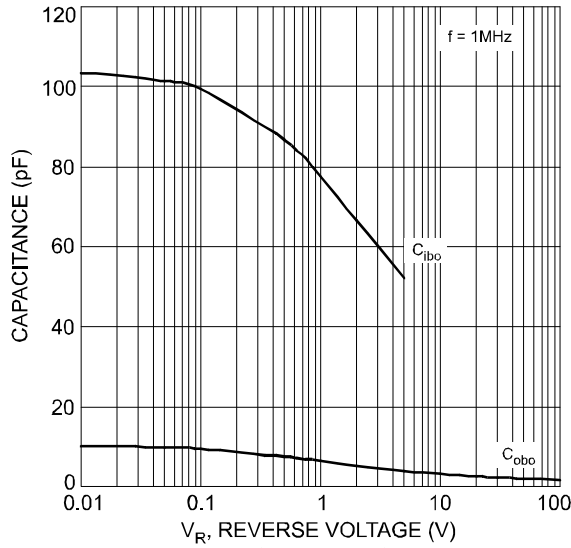

Fig. 7 Typical Capacitance Characteristics

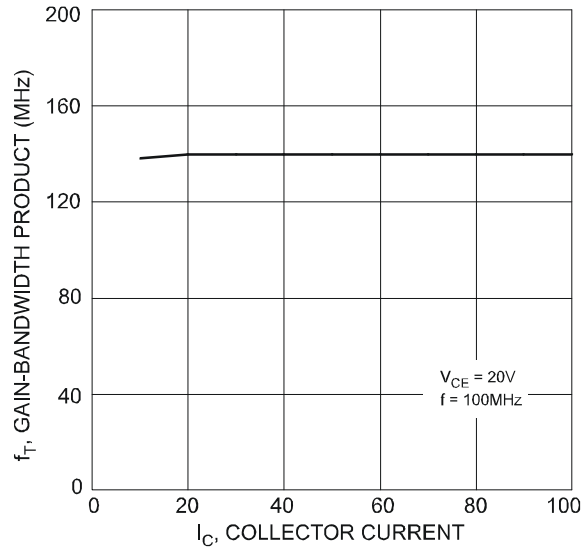

Fig. 8 Gain-Bandwidth Product vs. Collector Current

Ordering Information (Note 5)

Part Number	Case	Packaging
DXTA42-13	SOT89-3L	2500/Tape & Reel

Notes: 5. For packaging details, go to our website at <http://www.diodes.com/datasheets/ap02007.pdf>.

Marking Information

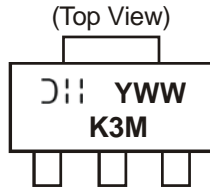

DII = Manufacturer's code marking
 K3M = Product Type Marking Code
 YWW = Date Code Marking
 Y = Last digit of year ex: 9 = 2009
 WW = Week code 01 - 52

Package Outline Dimensions

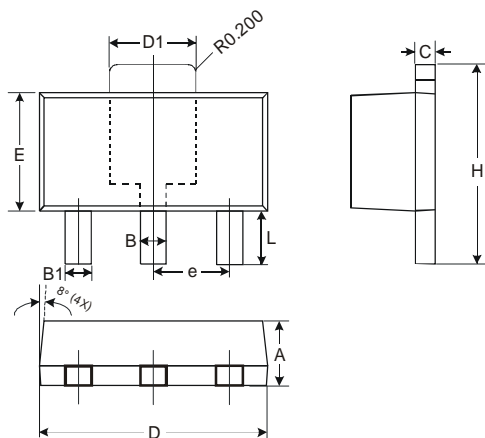

SOT89-3L			
Dim	Min	Max	Typ
A	1.40	1.60	1.50
B	0.45	0.55	0.50
B1	0.37	0.47	0.42
C	0.35	0.43	0.38
D	4.40	4.60	4.50
D1	1.50	1.70	1.60
E	2.40	2.60	2.50
e	—	—	1.50
H	3.95	4.25	4.10
L	0.90	1.20	1.05
All Dimensions in mm			

Suggested Pad Layout

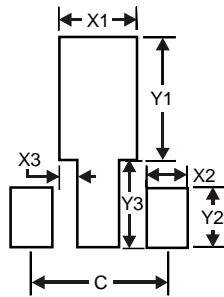

Dimensions	Value (in mm)
X1	1.7
X2	0.9
X3	0.4
Y1	2.7
Y2	1.3
Y3	1.9
C	3.0

IMPORTANT NOTICE

DIODES INCORPORATED MAKES NO WARRANTY OF ANY KIND, EXPRESS OR IMPLIED, WITH REGARDS TO THIS DOCUMENT, INCLUDING, BUT NOT LIMITED TO, THE IMPLIED WARRANTIES OF MERCHANTABILITY AND FITNESS FOR A PARTICULAR PURPOSE (AND THEIR EQUIVALENTS UNDER THE LAWS OF ANY JURISDICTION).

Diodes Incorporated and its subsidiaries reserve the right to make modifications, enhancements, improvements, corrections or other changes without further notice to this document and any product described herein. Diodes Incorporated does not assume any liability arising out of the application or use of this document or any product described herein; neither does Diodes Incorporated convey any license under its patent or trademark rights, nor the rights of others. Any Customer or user of this document or products described herein in such applications shall assume all risks of such use and will agree to hold Diodes Incorporated and all the companies whose products are represented on Diodes Incorporated website, harmless against all damages.

Diodes Incorporated does not warrant or accept any liability whatsoever in respect of any products purchased through unauthorized sales channel. Should Customers purchase or use Diodes Incorporated products for any unintended or unauthorized application, Customers shall indemnify and hold Diodes Incorporated and its representatives harmless against all claims, damages, expenses, and attorney fees arising out of, directly or indirectly, any claim of personal injury or death associated with such unintended or unauthorized application.

Products described herein may be covered by one or more United States, international or foreign patents pending. Product names and markings noted herein may also be covered by one or more United States, international or foreign trademarks.

LIFE SUPPORT

Diodes Incorporated products are specifically not authorized for use as critical components in life support devices or systems without the express written approval of the Chief Executive Officer of Diodes Incorporated. As used herein:

A. Life support devices or systems are devices or systems which:

1. are intended to implant into the body, or
2. support or sustain life and whose failure to perform when properly used in accordance with instructions for use provided in the labeling can be reasonably expected to result in significant injury to the user.

B. A critical component is any component in a life support device or system whose failure to perform can be reasonably expected to cause the failure of the life support device or to affect its safety or effectiveness.

Customers represent that they have all necessary expertise in the safety and regulatory ramifications of their life support devices or systems, and acknowledge and agree that they are solely responsible for all legal, regulatory and safety-related requirements concerning their products and any use of Diodes Incorporated products in such safety-critical, life support devices or systems, notwithstanding any devices- or systems-related information or support that may be provided by Diodes Incorporated. Further, Customers must fully indemnify Diodes Incorporated and its representatives against any damages arising out of the use of Diodes Incorporated products in such safety-critical, life support devices or systems.

Copyright © 2009, Diodes Incorporated

www.diodes.com