

DIO3581_3582_3584

1.4MHz, 60 μ A, Rail-to-Rail I/O CMOS Amplifier

Features

- Rail-to-Rail Input and Output
- Maxim offset (V_{OS}):
DIO3581/DIO3582/DIO3584@ $\pm 3\text{mV}$
- Unity Gain Stable
- Gain Bandwidth Product:1.4MHz
- Very low input bias currents:5pA
- Wide supply range:2V to 5.5V
- Input Voltage Range:
-0.1V to +5.6V with $V^+ = 5.5\text{V}$
- Ultra low power:60 μA per channel
- Compact Package best for portable applications
DIO3581: SOT23-5 and SC70-5
DIO3582: SOIC-8, MSOP-8 and DFN2*2-8
DIO3584: SOIC-14 and TSSOP-14

Applications

- ASIC Input or Output Amplifier
- Sensor Interface
- Piezo Electric Transducer Amplifier
- Medical Instrumentation
- Audio Output
- Portable Systems
- Smoke Detectors
- Notebook PC
- Battery-Powered equipment

Descriptions

DIO3581 (single), DIO3582 (dual) and DIO3584 (quad) are rail-to-rail CMOS operational amplifiers with ultra low offset. Features include wide input common-mode voltage range and broad output voltage swing with operating supply voltage from 2V to 5.5V. Products are fully specified over the extended -40 to 125°C temperature range.

DIO3581/DIO3582/DIO3584 provide 1.4MHz bandwidth consuming ultra low current of 60 μA per channel. Very low input bias currents of 5pA enable them ideal for integrators, photodiode amplifiers, and piezoelectric sensors.

Typical Application

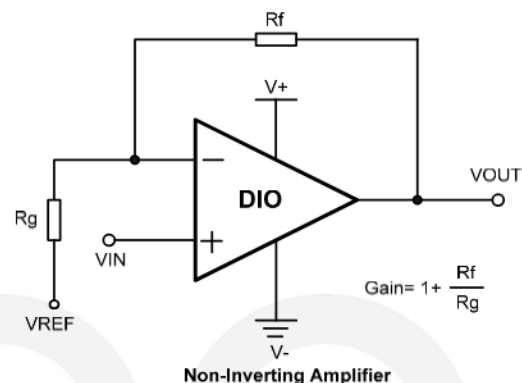

Ordering Information

| Order Part Number | Top Marking | | T _A | Package | |
|-------------------|-------------|---------------|----------------|----------|-------------------|
| DIO3581ST5 | YW(X)Z | RoHS or Green | -40 to 125°C | SOT23-5 | Tape & Reel, 3000 |
| DIO3581SC5 | YW(X)Z | RoHS or Green | -40 to 125°C | SC70-5 | Tape & Reel, 3000 |
| DIO3582MP8 | DIO358 | RoHS or Green | -40 to 125°C | MSOP-8 | Tape & Reel, 3000 |
| DIO3582SO8 | DIO358 | RoHS or Green | -40 to 125°C | SOIC-8 | Tape & Reel, 2500 |
| DIO3582CN8 | 3582 | RoHS or Green | -40 to 125°C | DFN2*2-8 | Tape & Reel, 3000 |
| DIO3584TP14 | DIO3584 | RoHS or Green | -40 to 125°C | TSSOP-14 | Tape & Reel, 2500 |
| DIO3584SO14 | DIO3584 | RoHS or Green | -40 to 125°C | SOIC-14 | Tape & Reel, 2500 |

Pin Assignments

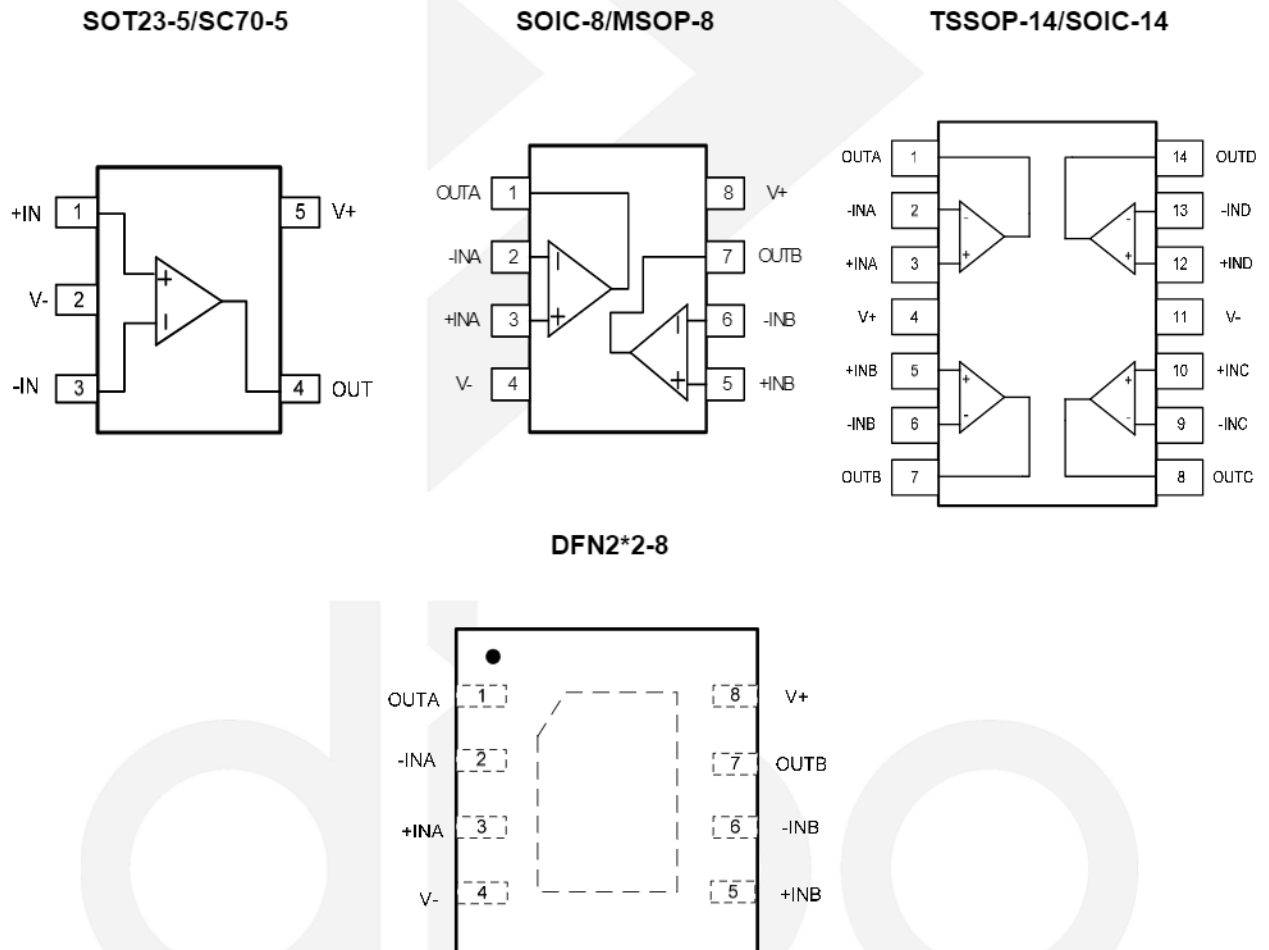

Figure 1 Pin Assignment

Pin Description

| Pin name | Description |
|----------|-----------------|
| V+ | Positive supply |
| V- | Negative supply |
| +INX | Positive Input |
| -INX | Negative Input |
| OUTX | Output |

Absolute Maximum Ratings

Stresses beyond those listed under "Absolute Maximum Rating" may cause permanent damage to the device. These are stress ratings only and functional operation of the device at these or any other condition beyond those indicated in the operational sections of the specifications is not implied. Exposure to absolute maximum rating conditions for extended periods may affect device reliability.

| Parameter | Rating | Unit |
|---------------------------|----------------------------|------|
| Supply Voltage | 7 | V |
| Input Voltage | (V ₋)-0.5 to 7 | V |
| Storage Temperature Range | -65 to 150 | °C |
| Junction Temperature | 150 | °C |
| Lead Temperature Range | 260 | °C |
| ESD | HBM, JEDEC: JESD22-A114 | kV |
| | CDM, JEDEC: JESD22-C101 | |

Recommended Operating Conditions

The Recommended Operating Conditions table defines the conditions for actual device operation to ensure optimal performance to the datasheet specifications. DIOO does not recommend exceeding them or designing to Absolute Maximum Ratings.

| Parameter | Rating | Unit |
|-----------------------------|-------------------------------|------|
| Supply Voltage | 2.0 to 5.5 | V |
| Input Voltage | -0.1 to (V ₊)+0.1 | V |
| Operating Temperature Range | -40 to 125 | °C |

Electrical Characteristics

Typical value: $V_{+}=5V$, $R_L=100k\Omega$ to $V_{+}/2$, $T_A = 25^{\circ}C$, unless otherwise specified.

| Symbol | Parameter | Conditions | Min. | Typ. | Max. | Unit |
|-------------------------------|--------------------------------|--|------|-------|---------------------|-------------------|
| INPUT CHARACTERISTICS | | | | | | |
| V_{OS} | Input Offset Voltage | $-40^{\circ}C \leq T_A \leq 125^{\circ}C$, $V_{+}=2V$ to $5V$ | -3 | 0.5 | 3 | mV |
| I_B | Input Bias Current | $-40^{\circ}C \leq T_A \leq 125^{\circ}C$, $V_{+}=2V$ to $5V$ | | 5 | | pA |
| I_{OS} | Input Offset Current | $-40^{\circ}C \leq T_A \leq 125^{\circ}C$, $V_{+}=2V$ to $5V$ | | 5 | | pA |
| V_{CM} | Common Mode Voltage Range | | -0.1 | | (V_{+}) +0.1 | V |
| CMRR | Common Mode Rejection Ratio | $-40^{\circ}C \leq T_A \leq 125^{\circ}C$, $V_{CM}=-0.1$ to (V_{+})+0.1 | 65 | 75 | | dB |
| A_{OL} | Open Loop Voltage Gain | $R_L=5k\Omega$, $V_O=0.1$ to (V_{+})-0.1 | 80 | 100 | | dB |
| | | $R_L=200k\Omega$, $V_O=0.1$ to (V_{+})-0.1 | 90 | 110 | | |
| $\Delta V_{OS}/\Delta T$ | Input Offset Voltage Drift | $-40^{\circ}C \leq T_A \leq 125^{\circ}C$ | | | 5 | $\mu V/^{\circ}C$ |
| OUTPUT CHARACTERISTICS | | | | | | |
| V_{OH} | Output Voltage High | $R_L=100k\Omega$, $-40^{\circ}C \leq T_A \leq 125^{\circ}C$ | | 4.998 | | V |
| V_{OL} | Output Voltage Low | $R_L=100k\Omega$, $-40^{\circ}C \leq T_A \leq 125^{\circ}C$ | | 2.5 | | mV |
| I_{SC} | Output Short Circuit Current | Source I_{SC} , $V_{+}=5V$ | | 40 | | mA |
| | | Sink I_{SC} , $V_{+}=5V$ | | 40 | | |
| POWER SUPPLY | | | | | | |
| PSRR | Power Supply Rejection Ration | | 65 | 85 | | dB |
| I_S | Supply Current per Channel/Amp | $-40^{\circ}C \leq T_A \leq 125^{\circ}C$ | | 60 | | μA |
| DYNAMIC PERFORMANCE | | | | | | |
| GBP | Gain Bandwidth Product | $R_L=100K$, $C_L=100pF$ | | 1.4 | | MHz |
| SR | Slew Rate | $G=1$, 2V Output Step | | 0.6 | | V/ μs |
| t_s | Setting Time | $G=1$, 2V Output Step | | 2.4 | | μs |
| NOISE PERFORMANCE | | | | | | |
| THD | Total Harmonic Distortion | $f=10kHz$, 2V Output Step, $R_L=10k\Omega$ | | 0.019 | | % |
| e_n | Voltage Noise Density | $f=1kHz$ | | 45 | | nV/ \sqrt{Hz} |
| | | $f=10kHz$ | | 35 | | |

Specifications subject to change without notice.

Typical Performance Characteristics

All typical value are at $V_+ = 2.5V$, $V_- = -2.5V$, $T_A = 25^\circ C$, unless otherwise specified.

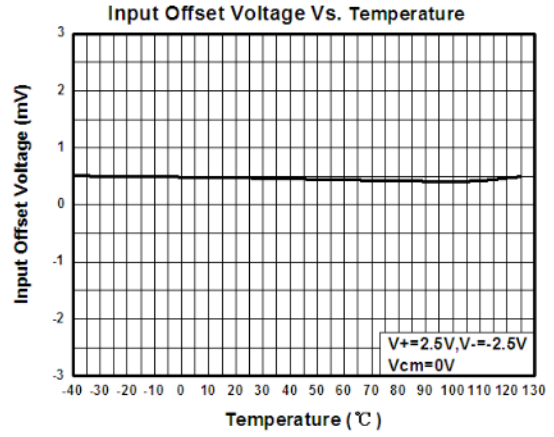
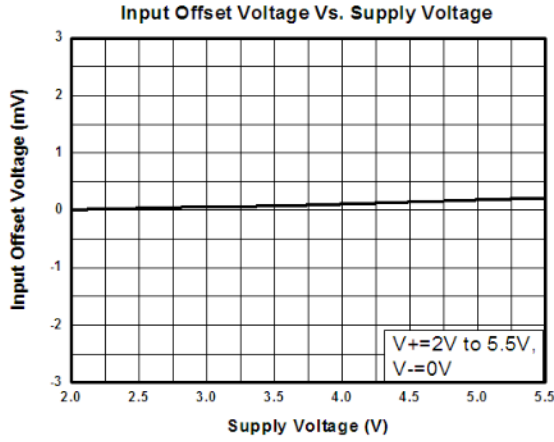

Input Offset Voltage Vs. Supply Voltage

Input Offset Voltage Vs. Temperature

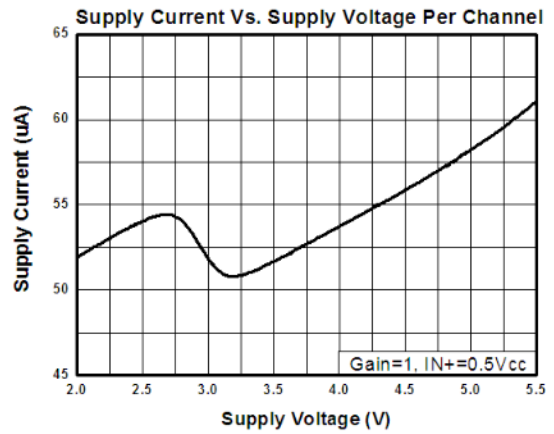
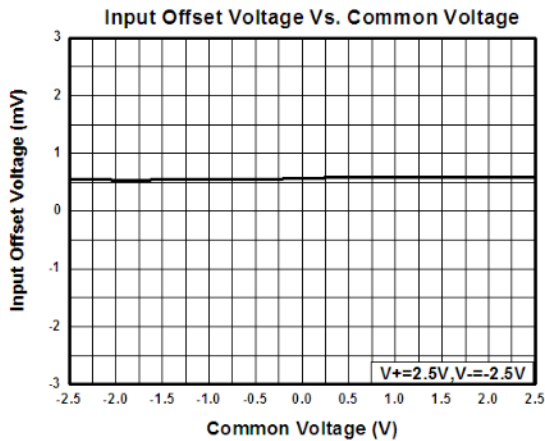

Input Offset Voltage Vs. Common Voltage

Supply Current Vs. Supply Voltage Per Channel

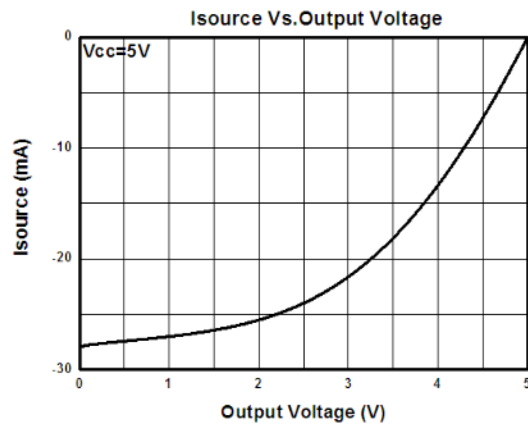
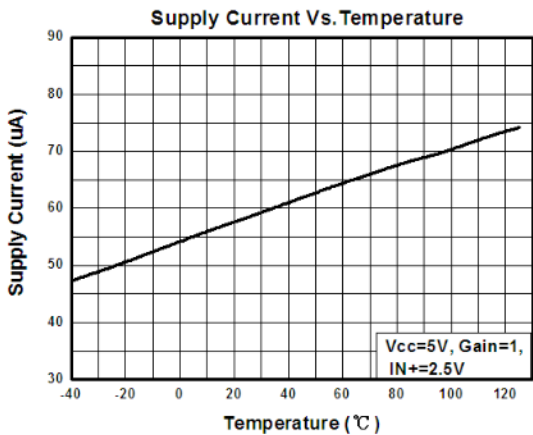

Supply Current Vs. Temperature

Isource Vs. Output Voltage

Typical Performance Characteristics(continued)

All typical value are at $V_+ = 2.5V$, $V_- = -2.5V$, $T_A = 25^\circ C$, unless otherwise specified.

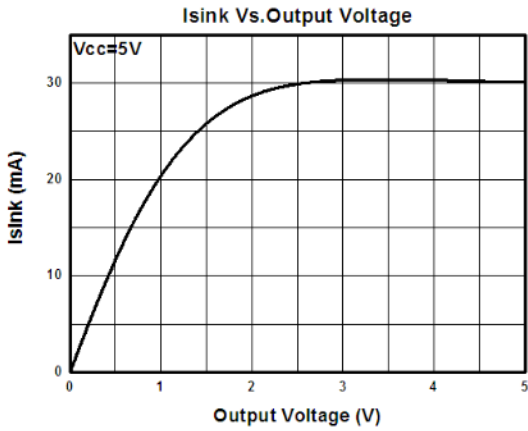

Isink Vs. Output Voltage

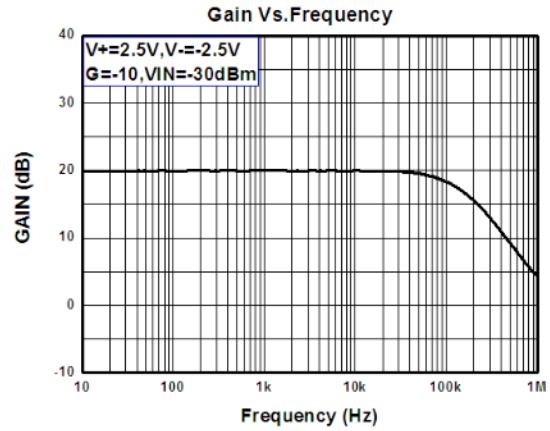

Gain Vs. Frequency

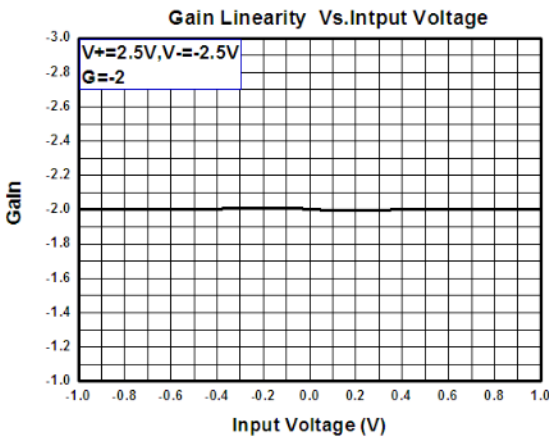

Gain Linearity Vs. Input Voltage

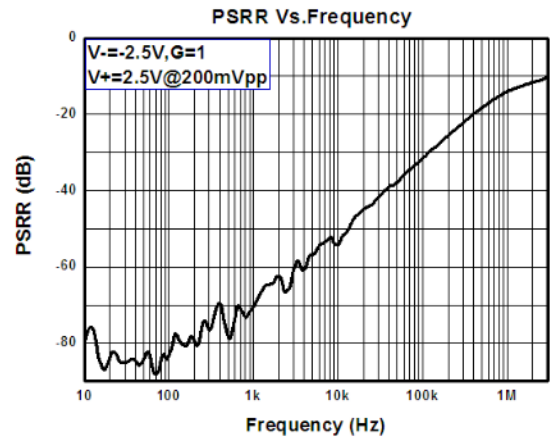

PSRR Vs. Frequency

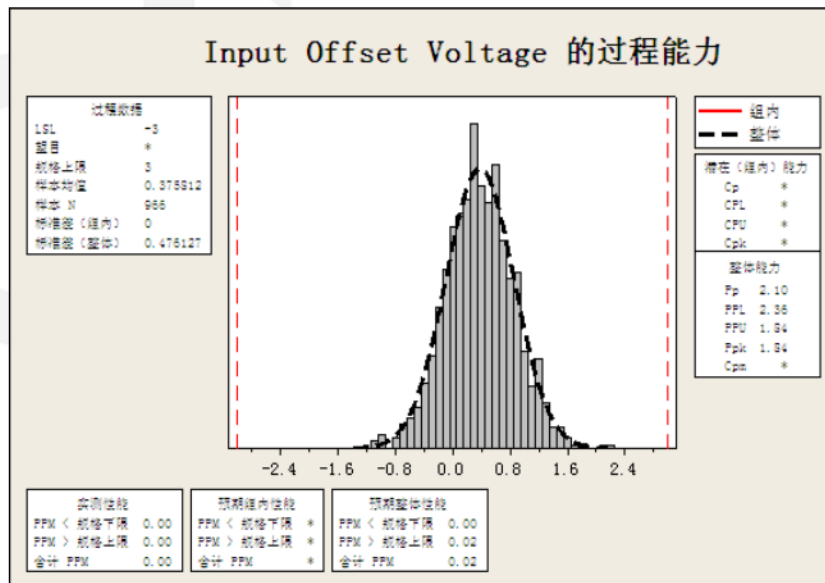

Input Offset Voltage Statistics

Typical Performance Characteristics(continued)

All typical value are at $V_+ = 2.5V$, $V_- = -2.5V$, $G = 1$, $R_L = 1M\Omega$, $T_A = 25^\circ C$, unless otherwise specified.

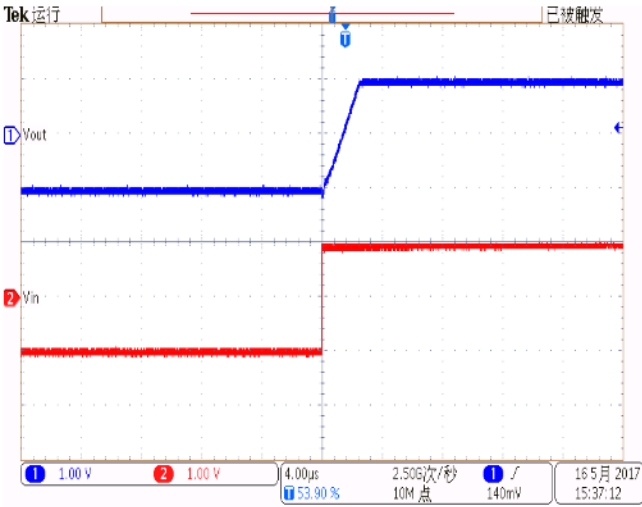

Slew Rate(+)

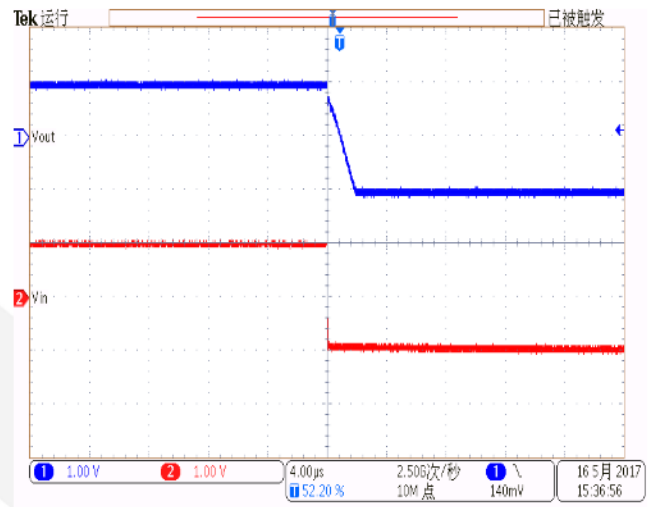

Slew Rate(-)

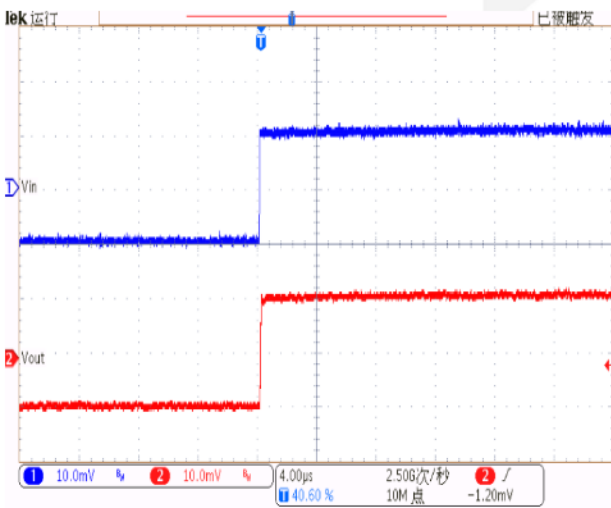

Small-Signal Response Rise ($C_L = \text{No Load}$)

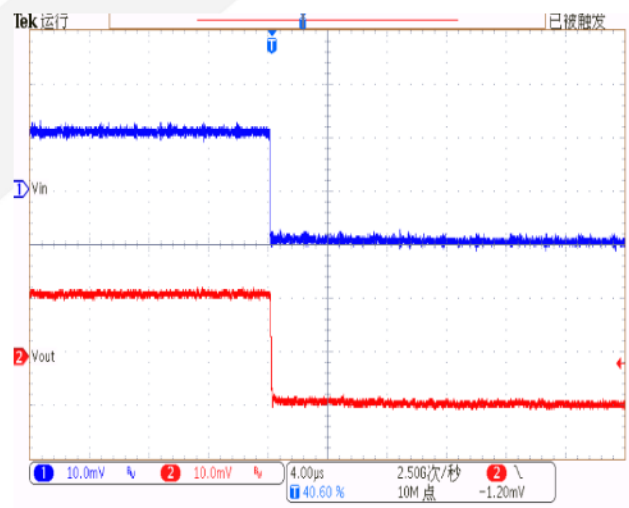

Small-Signal Response Fall ($C_L = \text{No Load}$)

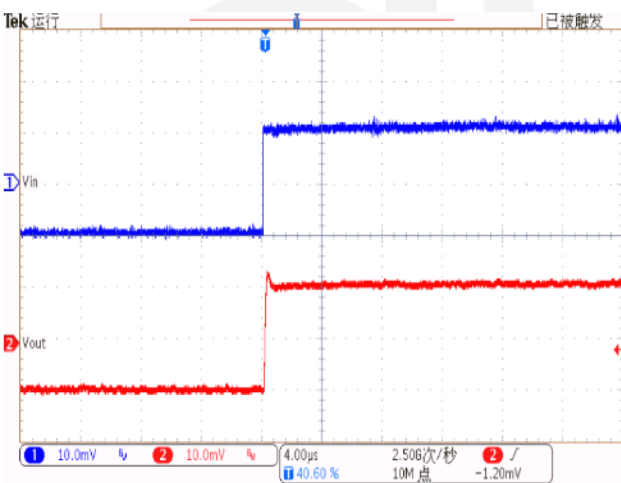

Small-Signal Response Rise ($C_L = 200pF$)

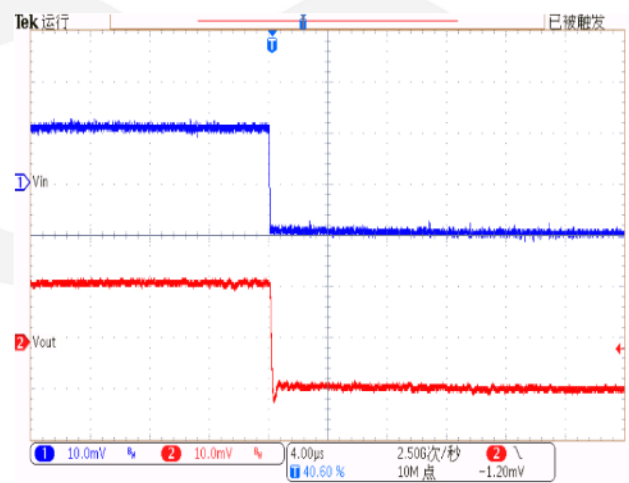

Small-Signal Response Fall ($C_L = 200pF$)

CONTACT US

Dioo is a professional design and sales corporation for high-quality and performance analog semiconductors. The company focuses on industry markets, such as, cell phone, handheld products, laptop, and medical equipment and so on. Dioo's product families include analog signal processing and amplifying, LED drivers and charger IC. Go to <http://www.dioo.com> for a complete list of Dioo product families.

For additional product information, or full datasheet, please contact with our Sales Department or Representatives.

