

## DIO3581\_3582\_3584

### 1.4MHz, 60 $\mu$ A, Rail-to-Rail I/O CMOS Amplifier

#### Features

- Rail-to-Rail Input and Output
- Maxim offset ( $V_{os}$ ):  
DIO3581/DIO3582/DIO3584@  $\pm 3\text{mV}$
- Unity Gain Stable
- Gain Bandwidth Product:1.4MHz
- Very low input bias currents:5pA
- Wide supply range:2V to 5.5V
- Input Voltage Range:  
-0.1V to +5.6V with  $V^+ = 5.5\text{V}$
- Ultra low power:60 $\mu\text{A}$  per channel
- Compact Package best for portable applications  
DIO3581: SOT23-5 and SC70-5  
DIO3582: SOIC-8, MSOP-8 and DFN2\*2-8  
DIO3584: SOIC-14 and TSSOP-14

#### Applications

- ASIC Input or Output Amplifier
- Sensor Interface
- Piezo Electric Transducer Amplifier
- Medical Instrumentation
- Audio Output
- Portable Systems
- Smoke Detectors
- Notebook PC
- Battery-Powered equipment

#### Descriptions

DIO3581 (single), DIO3582 (dual) and DIO3584 (quad) are rail-to-rail CMOS operational amplifiers with ultra low offset. Features include wide input common-mode voltage range and broad output voltage swing with operating supply voltage from 2V to 5.5V. Products are fully specified over the extended  $-40$  to  $125^\circ\text{C}$  temperature range.

DIO3581/DIO3582/DIO3584 provide 1.4MHz bandwidth consuming ultra low current of 60 $\mu\text{A}$  per channel. Very low input bias currents of 5pA enable them ideal for integrators, photodiode amplifiers, and piezoelectric sensors.

#### Typical Application

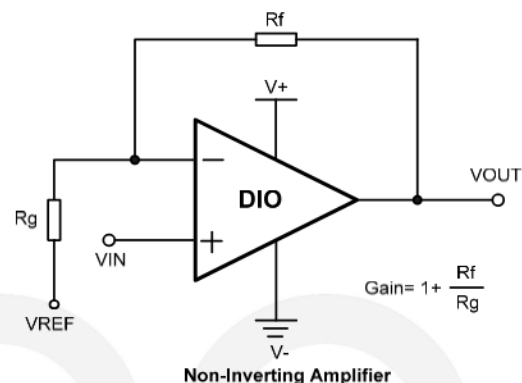

## Ordering Information

Order Part Number	Top Marking		T <sub>A</sub>	Package	
DIO3581ST5	YW(X)Z	RoHS or Green	-40 to 125°C	SOT23-5	Tape & Reel, 3000
DIO3581SC5	YW(X)Z	RoHS or Green	-40 to 125°C	SC70-5	Tape & Reel, 3000
DIO3582MP8	DIO358	RoHS or Green	-40 to 125°C	MSOP-8	Tape & Reel, 3000
DIO3582SO8	DIO358	RoHS or Green	-40 to 125°C	SOIC-8	Tape & Reel, 2500
DIO3582CN8	3582	RoHS or Green	-40 to 125°C	DFN2*2-8	Tape & Reel, 3000
DIO3584TP14	DIO3584	RoHS or Green	-40 to 125°C	TSSOP-14	Tape & Reel, 2500
DIO3584SO14	DIO3584	RoHS or Green	-40 to 125°C	SOIC-14	Tape & Reel, 2500

## Pin Assignments

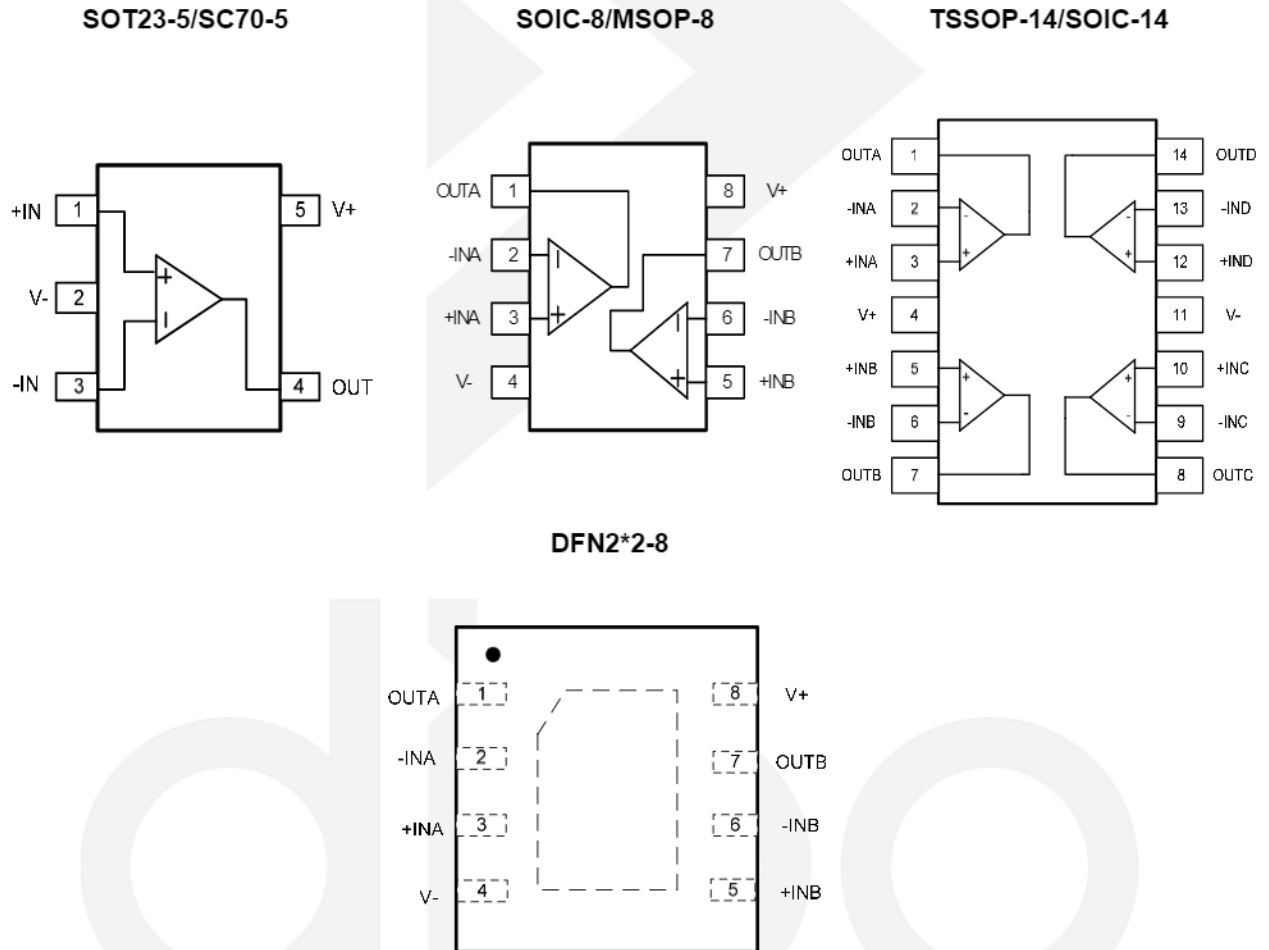

Figure 1 Pin Assignment

## Pin Description

Pin name	Description
V+	Positive supply
V-	Negative supply
+INX	Positive Input
-INX	Negative Input
OUTX	Output

## Absolute Maximum Ratings

Stresses beyond those listed under "Absolute Maximum Rating" may cause permanent damage to the device. These are stress ratings only and functional operation of the device at these or any other condition beyond those indicated in the operational sections of the specifications is not implied. Exposure to absolute maximum rating conditions for extended periods may affect device reliability.

Parameter	Rating	Unit
Supply Voltage	7	V
Input Voltage	(V <sub>-</sub> )-0.5 to 7	V
Storage Temperature Range	-65 to 150	°C
Junction Temperature	150	°C
Lead Temperature Range	260	°C
ESD	HBM, JEDEC: JESD22-A114	8
	CDM, JEDEC: JESD22-C101	2

## Recommended Operating Conditions

The Recommended Operating Conditions table defines the conditions for actual device operation to ensure optimal performance to the datasheet specifications. DIOO does not recommend exceeding them or designing to Absolute Maximum Ratings.

Parameter	Rating	Unit
Supply Voltage	2.0 to 5.5	V
Input Voltage	-0.1 to (V <sub>+</sub> )+0.1	V
Operating Temperature Range	-40 to 125	°C

## Electrical Characteristics

Typical value:  $V_{+}=5V$ ,  $R_L=100k\Omega$  to  $V_{+}/2$ ,  $T_A = 25^{\circ}C$ , unless otherwise specified.

Symbol	Parameter	Conditions	Min.	Typ.	Max.	Unit
<b>INPUT CHARACTERISTICS</b>						
$V_{OS}$	Input Offset Voltage	$-40^{\circ}C \leq T_A \leq 125^{\circ}C$ , $V_{+}=2V$ to $5V$	-3	0.5	3	mV
$I_B$	Input Bias Current	$-40^{\circ}C \leq T_A \leq 125^{\circ}C$ , $V_{+}=2V$ to $5V$		5		pA
$I_{OS}$	Input Offset Current	$-40^{\circ}C \leq T_A \leq 125^{\circ}C$ , $V_{+}=2V$ to $5V$		5		pA
$V_{CM}$	Common Mode Voltage Range		-0.1		( $V_{+}$ ) +0.1	V
CMRR	Common Mode Rejection Ratio	$-40^{\circ}C \leq T_A \leq 125^{\circ}C$ , $V_{CM}=-0.1$ to $(V_{+})+0.1$	65	75		dB
$A_{OL}$	Open Loop Voltage Gain	$R_L=5k\Omega$ , $V_O=0.1$ to $(V_{+})-0.1$	80	100		dB
		$R_L=200k\Omega$ , $V_O=0.1$ to $(V_{+})-0.1$	90	110		
$\Delta V_{OS}/\Delta T$	Input Offset Voltage Drift	$-40^{\circ}C \leq T_A \leq 125^{\circ}C$			5	$\mu V/^{\circ}C$
<b>OUTPUT CHARACTERISTICS</b>						
$V_{OH}$	Output Voltage High	$R_L=100k\Omega$ , $-40^{\circ}C \leq T_A \leq 125^{\circ}C$		4.998		V
$V_{OL}$	Output Voltage Low	$R_L=100k\Omega$ , $-40^{\circ}C \leq T_A \leq 125^{\circ}C$		2.5		mV
$I_{SC}$	Output Short Circuit Current	Source $I_{SC}$ , $V_{+}=5V$		40		mA
		Sink $I_{SC}$ , $V_{+}=5V$		40		
<b>POWER SUPPLY</b>						
PSRR	Power Supply Rejection Ration		65	85		dB
$I_S$	Supply Current per Channel/Amp	$-40^{\circ}C \leq T_A \leq 125^{\circ}C$		60		$\mu A$
<b>DYNAMIC PERFORMANCE</b>						
GBP	Gain Bandwidth Product	$R_L=100K$ , $C_L=100pF$		1.4		MHz
SR	Slew Rate	$G=1$ , 2V Output Step		0.6		V/ $\mu s$
$t_s$	Setting Time	$G=1$ , 2V Output Step		2.4		$\mu s$
<b>NOISE PERFORMANCE</b>						
THD	Total Harmonic Distortion	$f=10kHz$ , 2V Output Step, $R_L=10k\Omega$		0.019		%
$e_n$	Voltage Noise Density	$f=1kHz$		45		nV/ $\sqrt{Hz}$
		$f=10kHz$		35		

Specifications subject to change without notice.

## Typical Performance Characteristics

All typical value are at  $V_+ = 2.5V$ ,  $V_- = -2.5V$ ,  $T_A = 25^\circ C$ , unless otherwise specified.

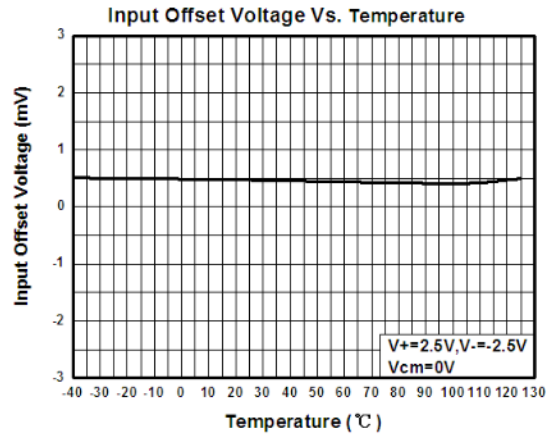
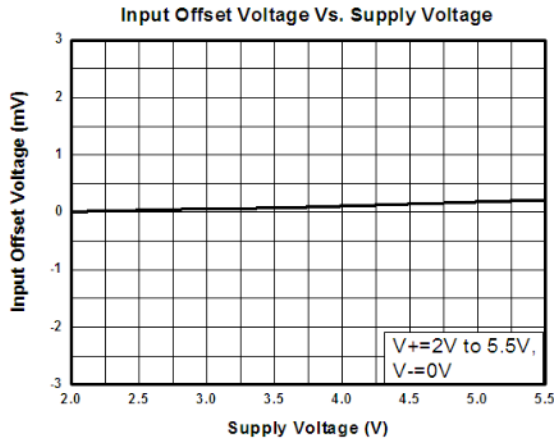

Input Offset Voltage Vs. Supply Voltage

Input Offset Voltage Vs. Temperature

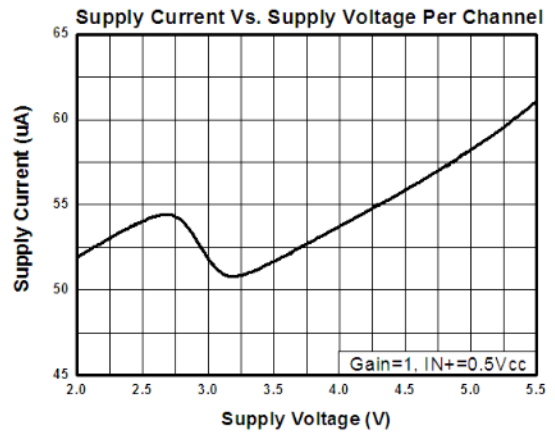
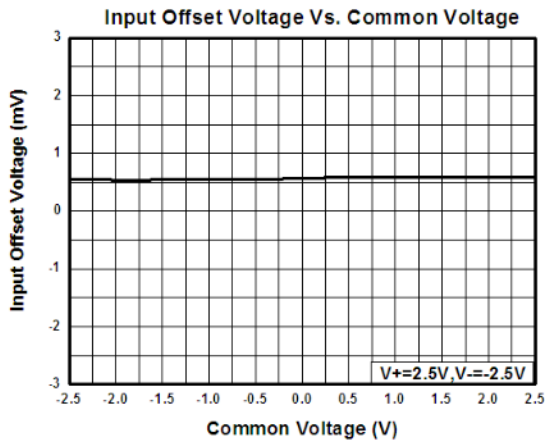

Input Offset Voltage Vs. Common Voltage

Supply Current Vs. Supply Voltage Per Channel

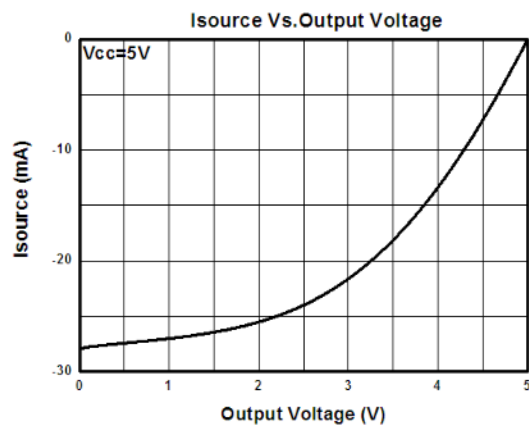
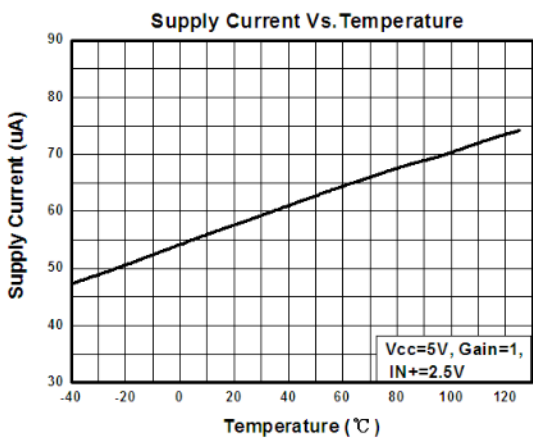

Supply Current Vs. Temperature

Isource Vs. Output Voltage

## Typical Performance Characteristics(continued)

All typical value are at  $V_+ = 2.5V$ ,  $V_- = -2.5V$ ,  $T_A = 25^\circ C$ , unless otherwise specified.

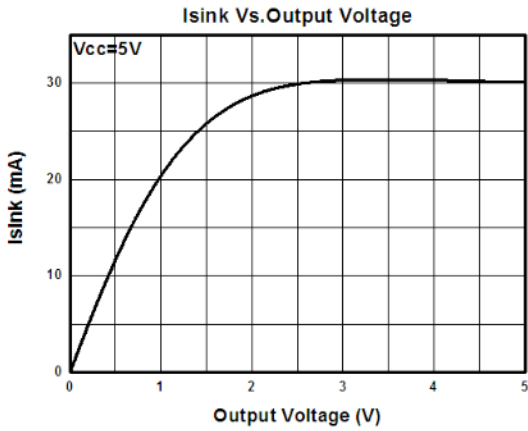

Isink Vs. Output Voltage

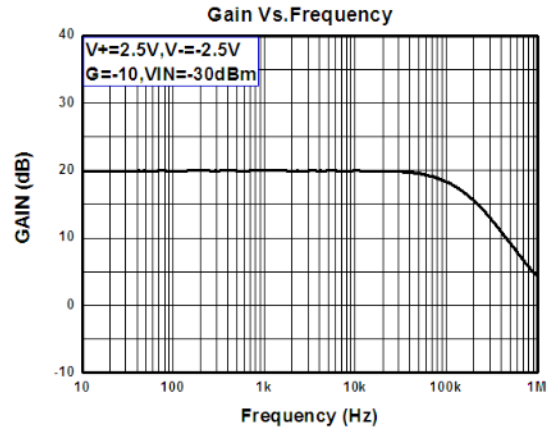

Gain Vs. Frequency

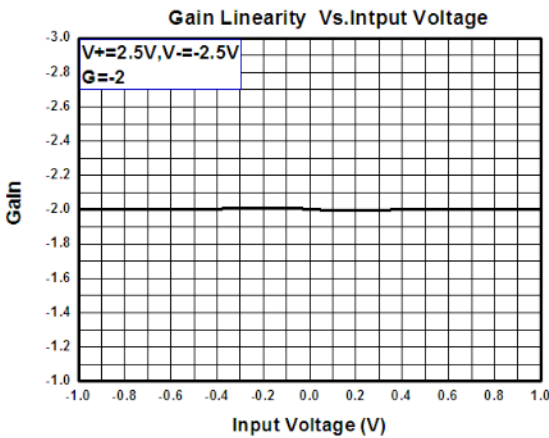

Gain Linearity Vs. Input Voltage

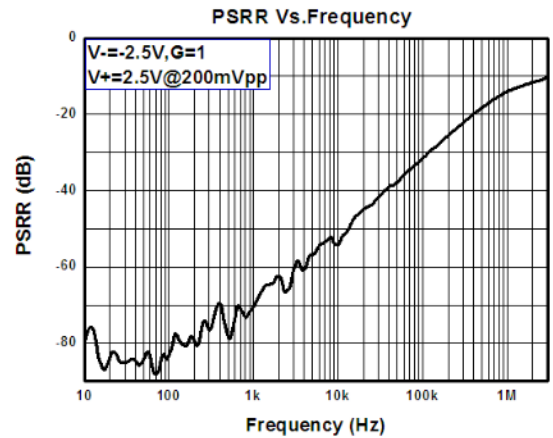

PSRR Vs. Frequency

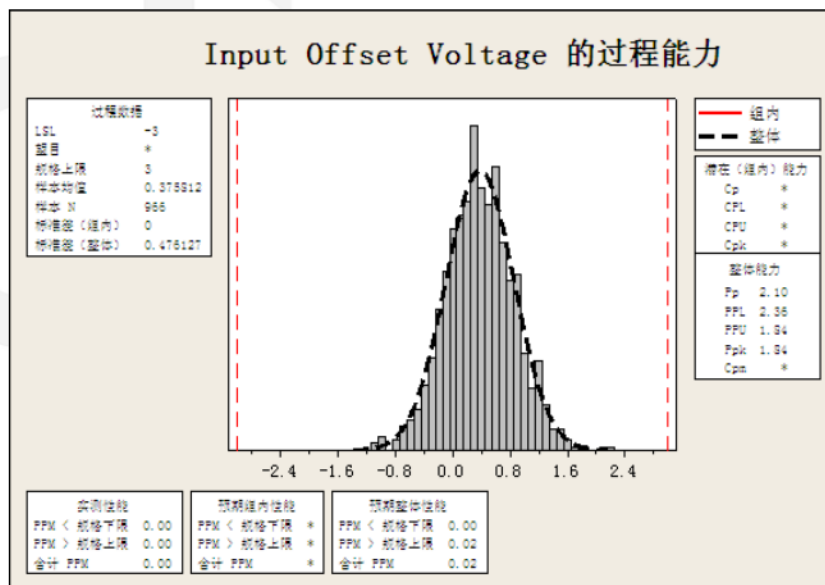

Input Offset Voltage Statistics



## Typical Performance Characteristics(continued)

All typical value are at  $V_+ = 2.5V$ ,  $V_- = -2.5V$ ,  $G = 1$ ,  $R_L = 1M\Omega$ ,  $T_A = 25^\circ C$ , unless otherwise specified.

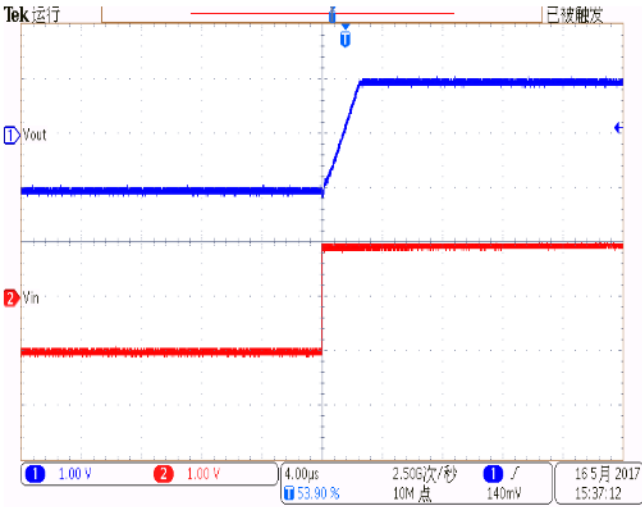

Slew Rate(+)

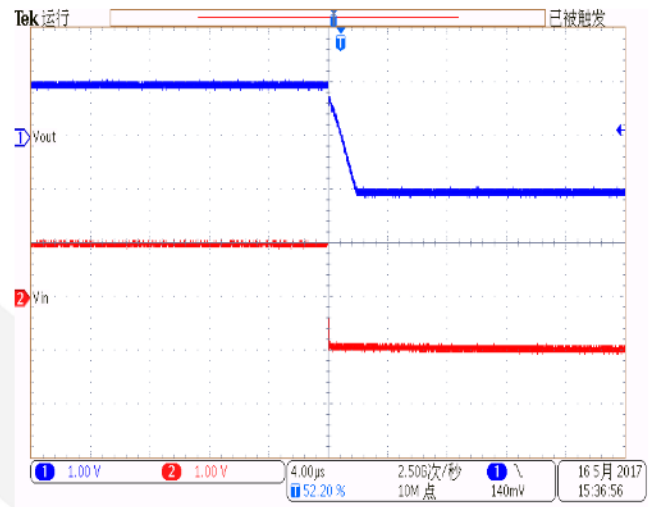

Slew Rate(-)

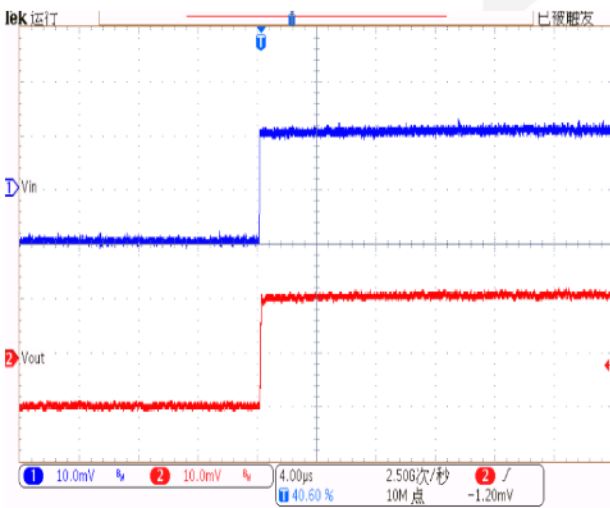

Small-Signal Response Rise ( $C_L = \text{No Load}$ )

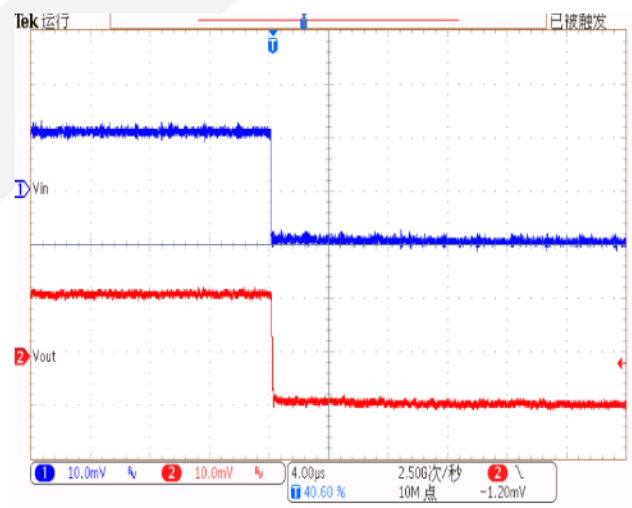

Small-Signal Response Fall ( $C_L = \text{No Load}$ )

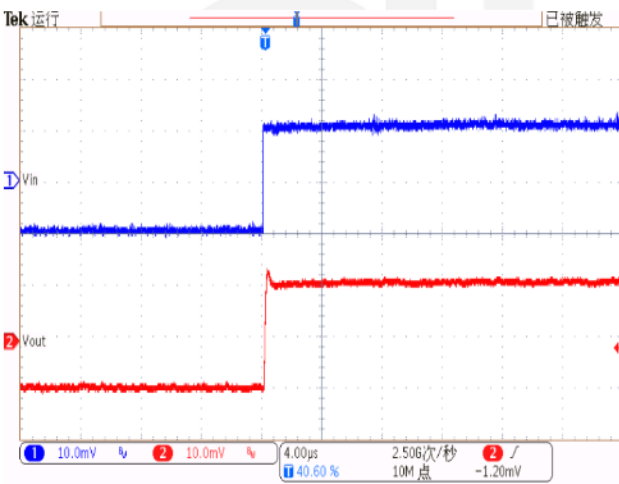

Small-Signal Response Rise ( $C_L = 200pF$ )

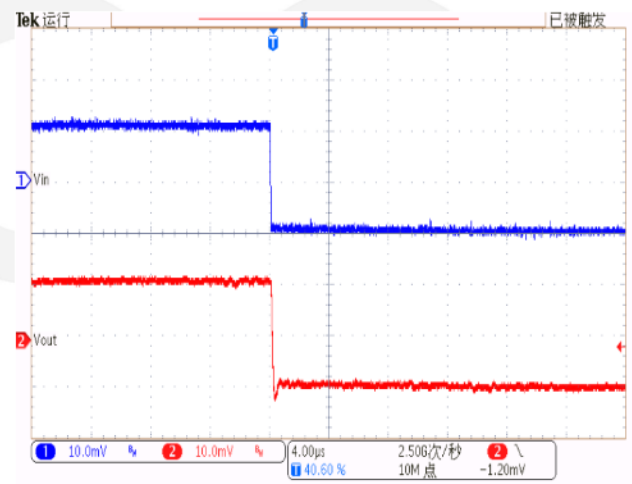

Small-Signal Response Fall ( $C_L = 200pF$ )

## CONTACT US

Dioo is a professional design and sales corporation for high-quality and performance analog semiconductors. The company focuses on industry markets, such as, cell phone, handheld products, laptop, and medical equipment and so on. Dioo's product families include analog signal processing and amplifying, LED drivers and charger IC. Go to <http://www.dioo.com> for a complete list of Dioo product families.

For additional product information, or full datasheet, please contact with our Sales Department or Representatives.

