

DIO2352A/B

30 μ V V_{OS} , 2.5kHz, RRIO CMOS High-Precision Amplifier

Features

- Rail-to-Rail Input and Output
- Low offset (V_{OS}): $\pm 30\mu V$
- Gain Error: $\pm 1\%$
- Input offset drift: $0.01\mu V/^\circ C$ (Max)
- Gain drift: $10ppm/^\circ C$ (Max)
- Gain Selection:
DIO2352A: 50V/V
DIO2352B: 100V/V
- Wide supply range: 2.5V to 5.5V
- Single Supply Operation
- Quiescent Current: $730\mu A$ (Typ)
- Available Package: SOIC-8, TSSOP-8

Descriptions

The DIO2352X is an ultra-low offset voltage rail-to-rail input and output voltage feedback amplifier. They have a wide input common-mode voltage range and output voltage swing, and take the operating supply voltage is from 2.5 to 5.5V.

The DIO2352X features an offset voltage of only $30\mu V$ and drift of $0.01\mu V/^\circ C$, which makes the product perfect in applications of intolerant errors. Temperature/position/pressure sensors and medical equipment can benefit greatly from nearly zero drift over their operating temperature range.

Applications

- Notebook Computer
- Mobile Phone
- Power Management IC
- Battery Charger
- Welding Equipment

Typical Application

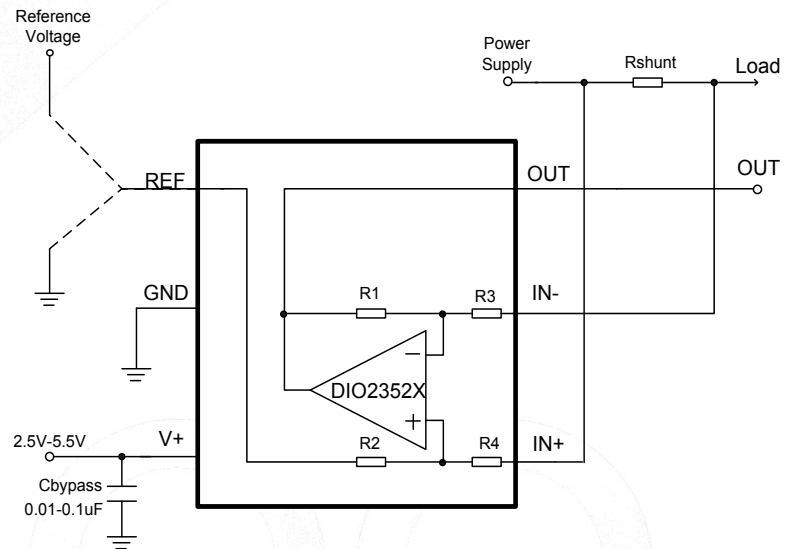

Ordering Information

Order Part Number	Top Marking		T_A	Package	
DIO2352ASO8	DIO2352A	Green/RoHS	-40 to +125 $^\circ C$	SOIC-8	Tape & Reel, 2500
DIO2352BSO8	DIO2352B	Green/RoHS	-40 to +125 $^\circ C$	SOIC-8	Tape & Reel, 2500
DIO2352ATP8	DIO2352A	Green/RoHS	-40 to +125 $^\circ C$	TSSOP-8	Tape & Reel, 3000
DIO2352BTP8	DIO2352B	Green/RoHS	-40 to +125 $^\circ C$	TSSOP-8	Tape & Reel, 3000

Physical Dimensions: SOIC-8

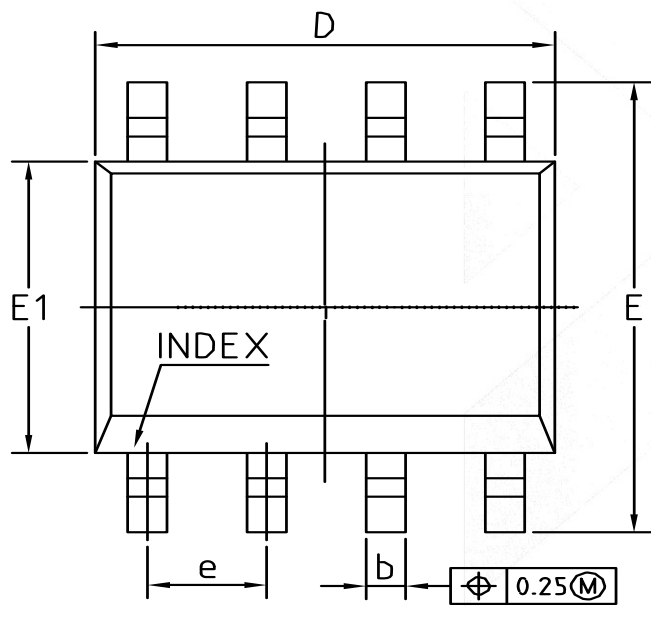
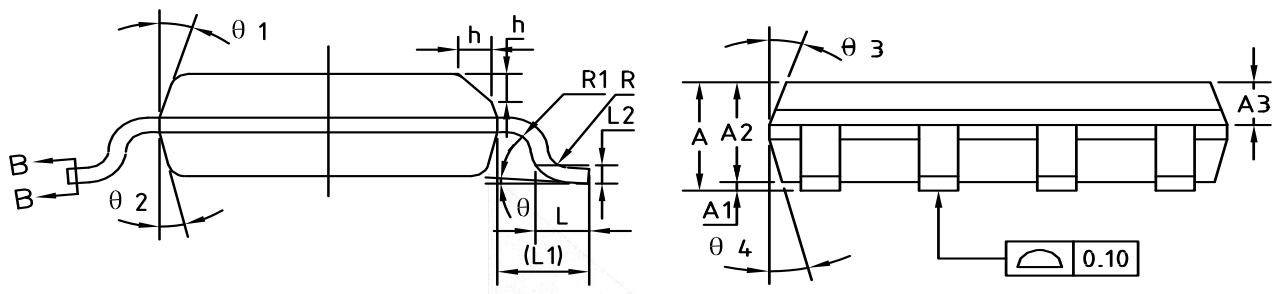

COMMON DIMENSIONS (UNITS OF MEASURE=MILLIMETER)			
Symbol	MIN	NOM	MAX
A	1.35	1.55	1.75
A1	0.10	0.15	0.25
A2	1.25	1.40	1.65
A3	0.50	0.60	0.70
b	0.38	-	0.51
b1	0.37	0.42	0.47
c	0.17	-	0.25
c1	0.17	0.20	0.23
D	4.80	4.90	5.00
E	5.80	6.00	6.20
E1	3.80	3.90	4.00
e	1.27BSC		
L	0.45	0.60	0.80
L1	1.04REF		
L2	0.25BSC		
R	0.07	-	-
R1	0.07	-	-
h	0.30	0.40	0.50
θ	0°	-	8°
$\theta 1$	15°	17°	19°
$\theta 2$	11°	13°	15°
$\theta 3$	15°	17°	19°
$\theta 4$	11°	13°	15°

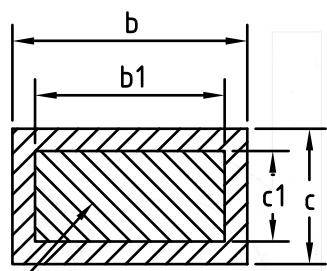

BASE METAL
SECTION B-B

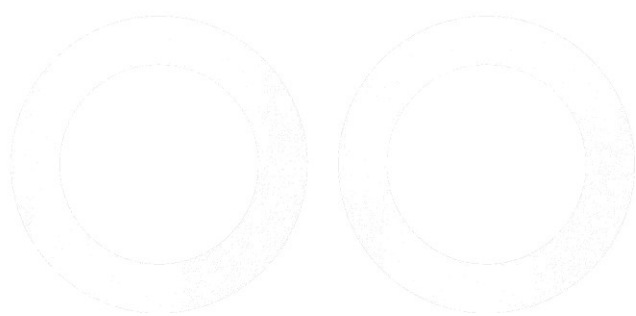

Physical Dimensions: TSSOP-8

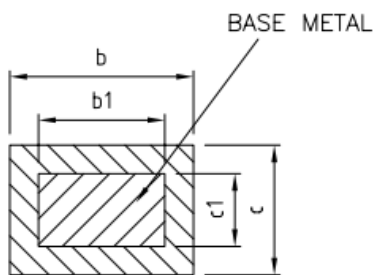
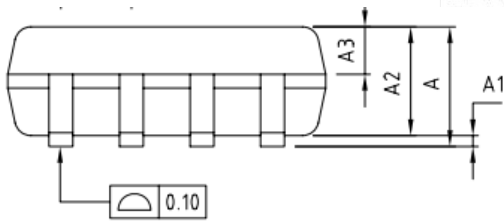
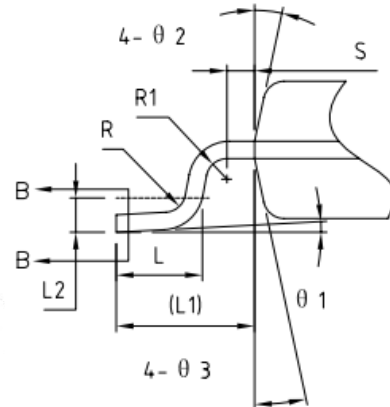
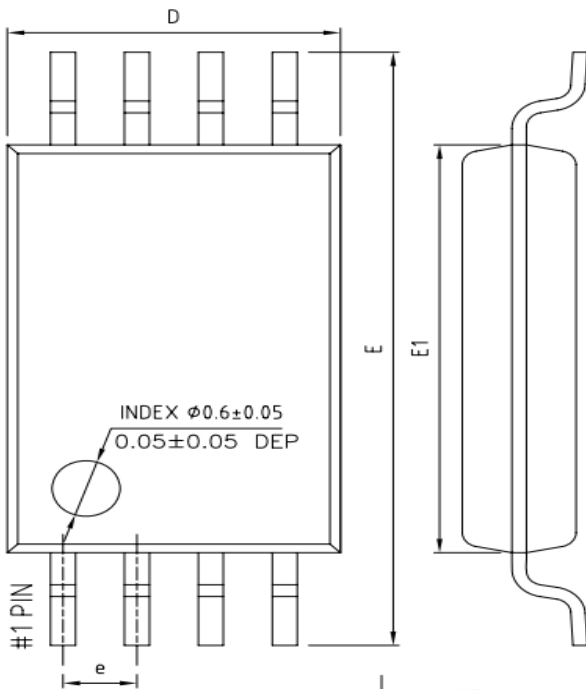

SECTION B-B

COMMON DIMENSIONS (UNITS OF MEASURE=MILLIMETER)			
Symbol	MIN	NOM	MAX
A	-	-	1.20
A1	0.05	-	0.15
A2	0.90	1.00	1.05
A3	0.34	0.44	0.54
b	0.20	-	0.28
b1	0.20	0.22	0.24
c	0.10	-	0.19
c1	0.10	0.13	0.15
D	2.83	2.93	3.03
E	6.20	6.40	6.60
E1	4.30	4.40	4.50
e	0.65BSC		
L	0.45	0.60	0.75
L1	1.00REF		
L2	0.25BSC		
R	0.09	-	-
R1	0.09	-	-
S	0.20	-	-
$\theta 1$	0°	-	8°
$\theta 2$	10°	12°	14°
$\theta 3$	10°	12°	14°



DIO2352X

30 μ V V_{os} 2.5KHz, RRIO CMOS High-Precision Amplifier

CONTACT US

Dioo is a professional design and sales corporation for high-quality and performance analog semiconductors. The company focuses on industry markets, such as, cell phone, handheld products, laptop, and medical equipment and so on. Dioo's product families include analog signal processing and amplifying, LED drivers and charger IC. Go to <http://www.dioo.com> for a complete list of Dioo product families.

For additional product information, or full datasheet, please contact with our Sales Department or Representatives.

