

DIO1281

Over-Voltage Protection Load Switch

Features

- Surge Protection
 - IEC 61000-4-5: >100V
- Over-Voltage Protection (OVP)
- Over-Temperature Protection (OTP)
- ESD Protection
 - IEC 61000-4-2 Air Discharge: >15kV
 - IEC 61000-4-2 Contact Discharge: >8kV
- +/- 100V EOS Protection
- Negative Voltage Protection(-30V)

Applications

- Mobile Handsets and Tablets
- Portable Media Players
- MP3 Players

Descriptions

The DIO1281 features a low-RON internal FET and an operating range of 2.5 V_{DC} to 25 V_{DC} (absolute maximum of 30V_{DC}). An internal clamp is capable of shunting surge voltages >100V, protecting downstream components and enhancing system robustness. The DIO1281 features over-voltage protection that powers down the internal FET if the input voltage exceeds the OVP threshold. The OVP threshold is adjustable with optional external resistors. Over-temperature protection also powers down the device at 130°C (typical). Exceptionally low off-state current (<1μA maximum) facilitates compliance with standby power requirements.

The DIO1281 is available in a fully “green” compliant 1.3mm x 1.8mm Wafer-Level Chip-Scale Package (WLCSP) with backside laminate.

Function Block Diagram

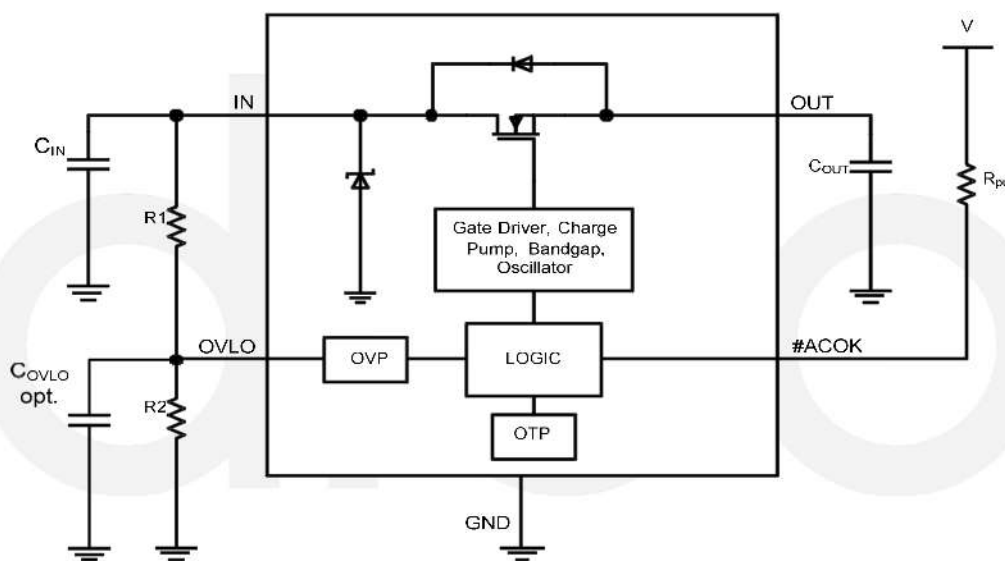
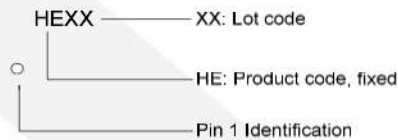

Figure 1 Functional Block Diagram

Ordering Information

Order Part Number	Top Marking		T _A	Package	
DIO1281WL12	HEXX	Green	-40 to +85°C	WLCSP-12 0.4mm pitch	Tape & Reel, 3000

Marking Definition



Pin Configuration

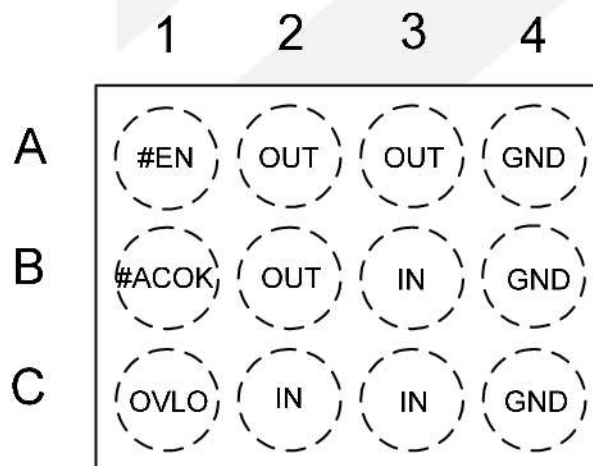

Figure 2 Pin Assignment (Top View)

Pin Definitions

Name	Bump	Type	Description	
IN	B3,C2,C3	Input/Supply	Switch Input and Device Supply	
OUT	A2,A3,B2	Output	Switch Output to Load	
#ACOK	B1	Output	1	$V_{IN} < V_{IN_min}$ or $V_{IN} \geq V_{OVLO}$
			0	Voltage Stable
#EN	A1	Input	Device Enable	
OVLO	C1	Input	Over-Voltage Lockout Adjustment Pin	
GND	A4,B4,C4	Supply	Device Ground	



DIO1281

Over-Voltage Protection Load Switch

Absolute Maximum Ratings

Stresses beyond those listed under "Absolute Maximum Rating" may cause permanent damage to the device. These are stress ratings only and functional operation of the device at these or any other condition beyond those indicated in the operational sections of the specifications is not implied. Exposure to absolute maximum rating conditions for extended periods may affect device reliability.

Symbol	Parameter	Rating	Unit	
V _{IN}	V _{IN} to GND & V _{IN} to V _{OUT} = GND or Float	-0.3 to +30	V	
V _{OUT}	V _{OUT} to GND	-0.3 to V _{IN} +0.3	V	
V _{OVLO}	OVLO to GND	-0.3 to 30	V	
V _{#EN_ACOK}	Maximum DC Voltage Allowed on #EN or ACOK Pin	6	V	
I _{IN}	Switch I/O Current (Continuous)	4.5	A	
I _{IK}	Input Clamp Diode Current (All Pins Except V _{IN})	-50	mA	
t _{PD}	Total Power Dissipation at T _A =25°C	1.55	mW	
T _{STG}	Storage Temperature Range	-65 to +150	°C	
T _J	Maximum Junction Temperature	+150	°C	
T _L	Lead Temperature (Soldering, 10 Seconds)	+260	°C	
θ _{JA}	Thermal Resistance, Junction-to-Ambient	84.1	°C/W	
ESD	IEC 61000-4-2 System ESD	Air Gap	15.0	kV
		Contact	8.0	
Surge	IEC 61000-4-5, Surge Protection	V _{IN}	100	V

Recommended Operating Conditions

Symbol	Parameter	Min	Typ.	Max	Unit
V _{IN}	Supply Voltage	2.5		20.0	V
T _A	Operating Temperature	-40		+85	°C
I _{OUT}	Output Current			3	A



DIO1281

Over-Voltage Protection Load Switch

Electrical Characteristics

$T_A = -40^{\circ}\text{C}$ to 85°C , unless otherwise specified. Typical values are $V_{IN}=5.0\text{V}$, $I_{IN}\leq 3\text{A}$, $C_{IN}=0.1\mu\text{F}$ and $T_A=25^{\circ}\text{C}$.

Symbol	Parameter	Test Conditions	Min	Typ	Max	Unit
V_{IN_CLAMP}	Input Clamping Voltage	$I_{IN}=10\text{mA}$		35		V
I_Q	Input Quiescent Current	$V_{IN}=5\text{V}$, $\#EN=0\text{V}$		58	100	μA
I_{IN_Q}	OVLO Supply Current	$V_{OVLO}=3\text{V}$, $V_{IN}=5\text{V}$, $V_{OUT}=0\text{V}$		52	100	μA
V_{IN_OVLO}	Internal Over-Voltage Trip Level	V_{IN} Rising	13.6	14.0	14.4	V
		V_{IN} Falling	13.0			V
V_{OVLO_TH}	OVLO Set Threshold	$V_{IN}=2.5\text{V}$ to V_{OVLO}	1.12	1.20	1.24	
V_{OVLO_RNG}	Adjustable OVLO Threshold Range	$V_{IN}=2.5\text{V}$ to V_{OVLO}	4		20	V
V_{OVLO_SELECT}	External OVLO Select Threshold			0.30	0.28	V
R_{ON}	Resistance from V_{IN} to V_{OUT}	$V_{IN}=5\text{V}$, $I_{OUT}=1\text{A}$, $T_A=25^{\circ}\text{C}$		20	39	$\text{m}\Omega$
C_{OUT}	OUT Load Capacitance	$V_{IN}=5\text{V}$			1000	μF
I_{OLVO}	OVLO Input Leakage Current	$V_{OVLO}=V_{OVLO_TH}$	-100		100	nA
T_{SDN}	Thermal Shutdown			130		$^{\circ}\text{C}$
T_{SDN_HYS}	Thermal Shutdown Hysteresis			20		$^{\circ}\text{C}$
Digital Signals						
V_{OL}	#ACOK Output Low Voltage	$I_{SINK}=1\text{mA}$			0.4	V
V_{IH_EN}	Enable HIGH Voltage	$V_{IN}=2.5\text{V}$ to V_{OVLO}	1.2			V
V_{IL_EN}	Enable LOW Voltage	$V_{IN}=2.5\text{V}$ to V_{OVLO}			0.5	V
I_{ACOK_LEAK}	#ACOK Leakage Current	$V_{ACOK}=3\text{V}$, #ACOK Deasserted	-0.5		0.5	μA
$\#EN_Leak$	#EN Leakage Current	$V_{IN}=5.0\text{V}$, $V_{OUT}=\text{Float}$	-1.0		1.0	μA
Timing Characteristics						
t_{DEB}	Debounce Time	Time from $2.5\text{V} < V_{IN} < V_{IN_OVLO}$ to $V_{OUT}=0.1 \times V_{IN}$		15		ms
t_{START}	Soft-Start Time	Time from $V_{IN}=V_{IN_min}$ to $0.2 \times \#ACOK$, $V_{IO}=1.8\text{V}$ with $10\text{k}\Omega$ Pull-up Resistor		30		ms
t_{ON}	Switch Turn-On Time	$R_L=100\Omega$, $C_L=22\mu\text{F}$, V_{OUT} from $0.1 \times V_{IN}$ to $0.9 \times V_{IN}$		2		ms
t_{OFF}	Switch Turn-Off Time	$R_L=100\Omega$, $C_L=0\mu\text{F}$, $V_{IN} > V_{OVLO}$ to $V_{OUT}=0.8 \times V_{IN}$		125		ns

Specifications subject to change without notice.

Timing Diagrams:

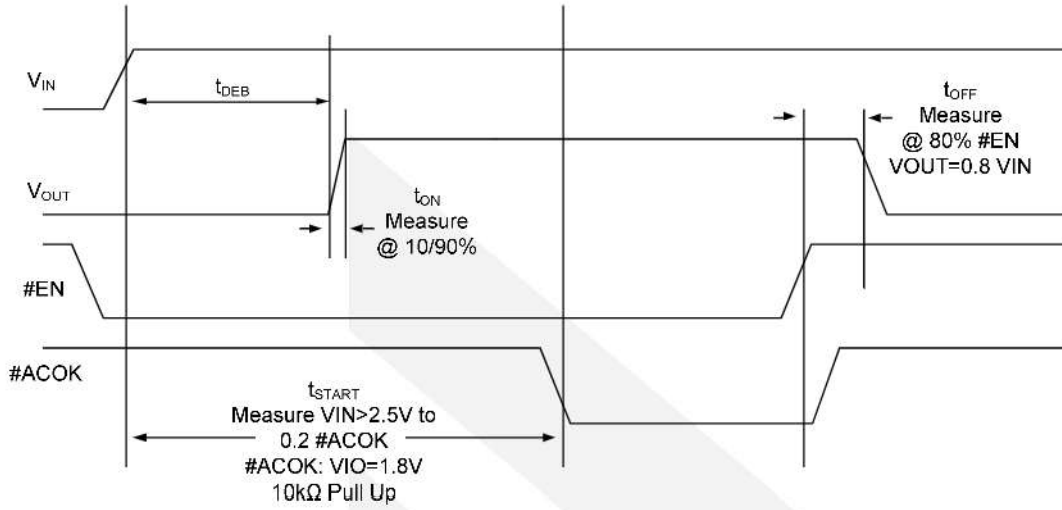

Figure 3 Timing for Power Up and Normal Operation

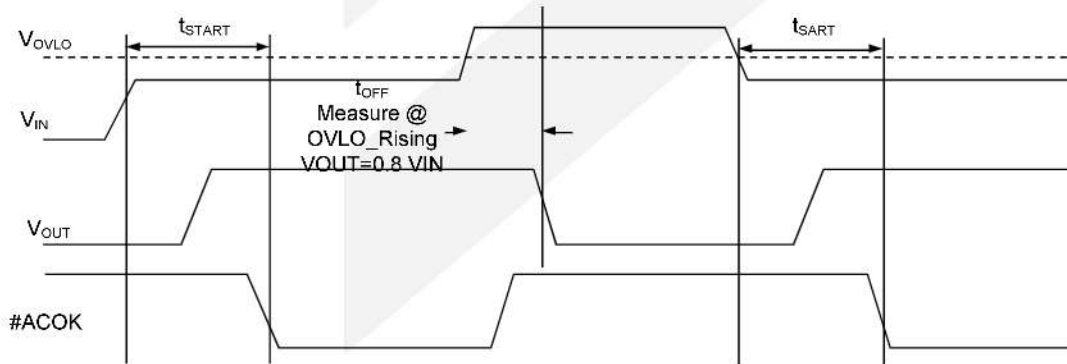
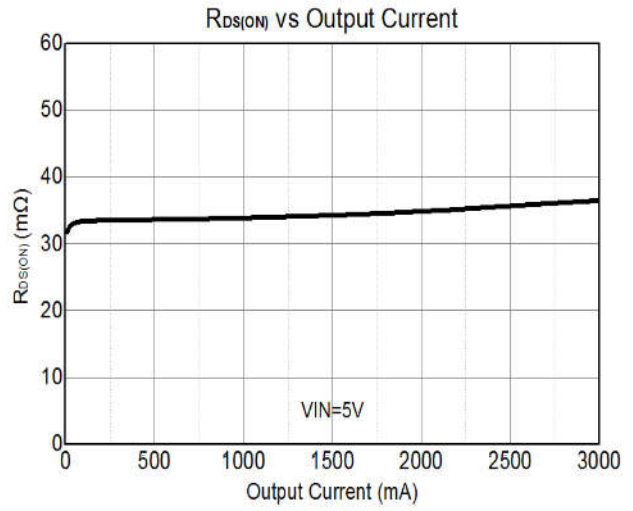
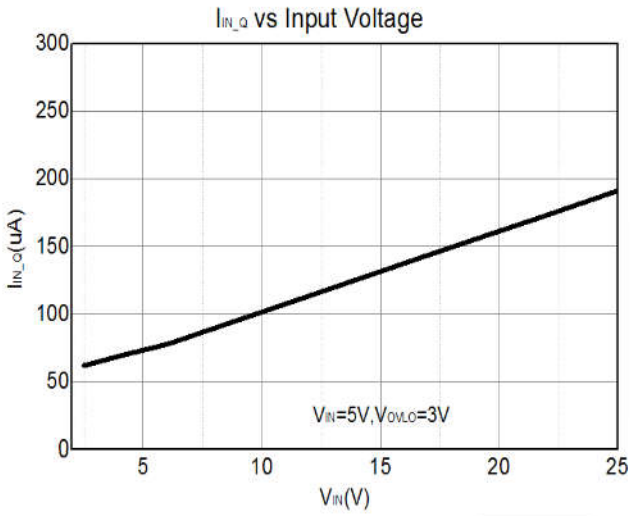

Figure 4 Timing for OVLO Trip



Typical Performance Characteristics

Ambient temperature is 25°C, $V_{IN}=5V$, $I_{IN}\leq 3A$, $C_{IN}=1\mu F$, $C_{OUT}=1\mu F$, unless otherwise noted.



VIN Power ON ($V_{IN}=5V$, No Load)

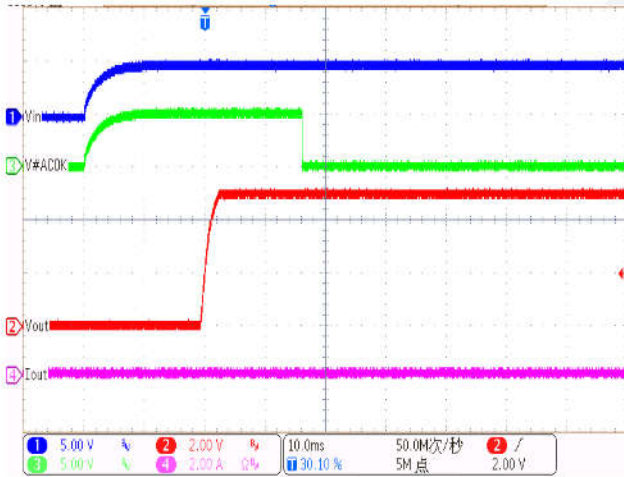

VIN Power OFF ($V_{IN}=5V$, No Load)

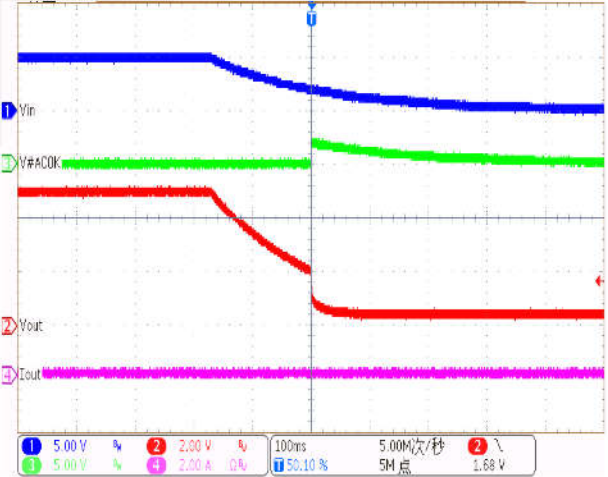

VIN Power ON ($V_{IN}=5V, R_{Load}=1.6ohm$)

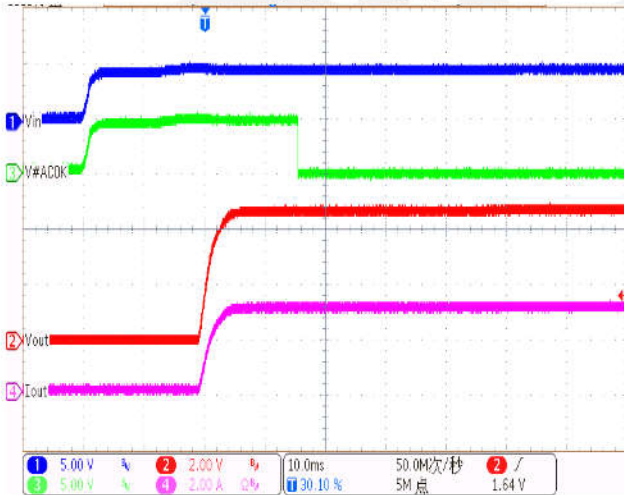

VIN Power OFF ($V_{IN}=5V, R_{Load}=1.6ohm$)

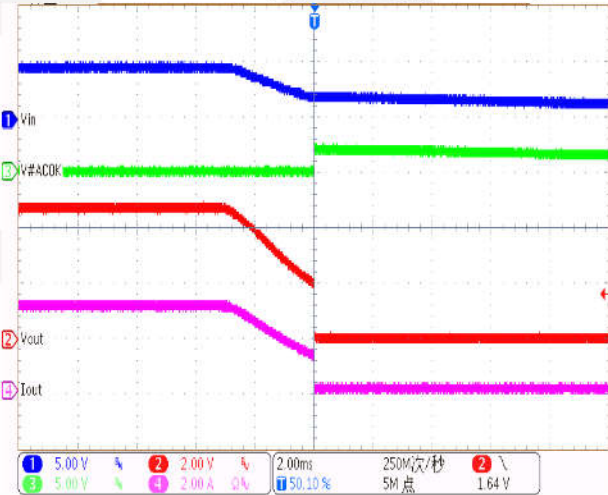

EN Power ON ($V_{IN}=5V$, No Load)

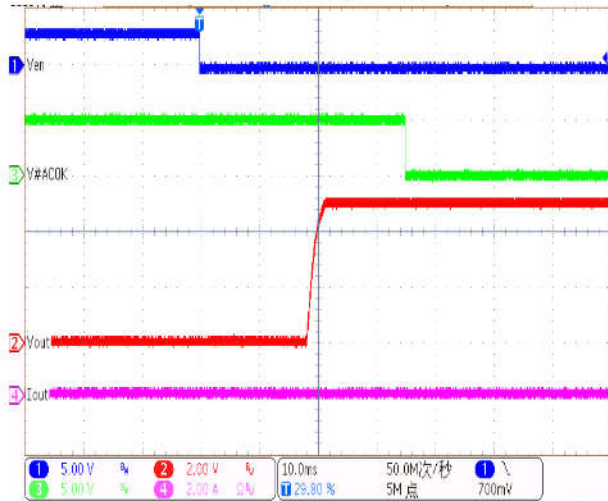

EN Power OFF ($V_{IN}=5V$, No Load)

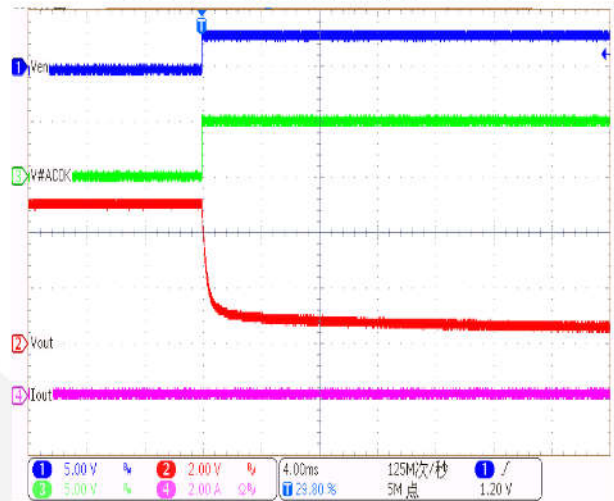

EN Power ON ($V_{IN}=5V$, $R_{Load}=1.6\Omega$)

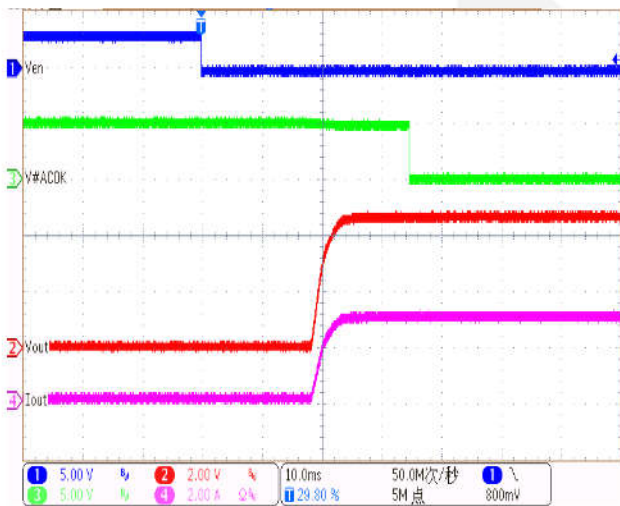

EN Power OFF ($V_{IN}=5V$, $R_{Load}=1.6\Omega$)

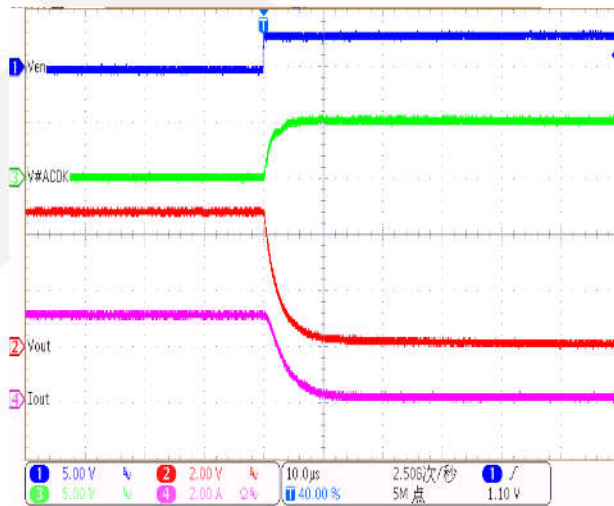

Over-Voltage Lockout (OVLO) Calculation:

OVLO can be set externally and override default OVP. By connecting an external resistor-driver to the OVLO pin. Equation (1) can produce the desired trip voltage and resistor values.

$$V_{IN_OVLO} = V_{OVLO_TH} \cdot [1 + R1 / R2] \quad (1)$$

Recommended minimum $R1=820k\Omega$.



DIO1281

Over-Voltage Protection Load Switch

CONTACT US

Dioo is a professional design and sales corporation for high-quality and performance analog semiconductors. The company focuses on industry markets, such as, cell phone, handheld products, laptop, and medical equipment and so on. Dioo's product families include analog signal processing and amplifying, LED drivers and charger IC. Go to <http://www.dioo.com> for a complete list of Dioo product families.

For additional product information, or full datasheet, please contact with our Sales Department or Representatives.

dioo