

 **Defond**



## VISION ■ 愿景

Powering You Up For SUCCESS  
携手打造成功

## MISSION ■ 使命

- 1 Work with all stakeholders to create solutions and values  
与所有权益者共创有效方案及价值
- 2 Invest in our business and people to become the market leader  
持续投资于业务及人力资源，确占市场领导地位
- 3 Provide superior quality on cost effective products and services with a focus on innovation and continuous improvement  
致力于技术创新和持续改善，提供优质性价比的产品及服务



## Introduction 前言

- In a challenging and dynamic environment, Defond has grown to be a great switch manufacturer in Hong Kong. Defond has become a reputed supplier of components for home appliances and various industrial applications since 1978.

Defond possesses the unique combination of electronic, electrical and mechanical expertise. Vertically integrated manufacturing technologies are applied in plastic molding, metal forming and plating, coil winding, through-hole and surface mount electronics assemblies. The company is committed to providing customers with a total solution from the initial design stages through to manufacturing, delivering outstanding product quality, fast turnaround time and competitive pricing.

在一个极具挑战但又充满活力的市场环境下，目前，德丰已成为香港最大的开关制造集团。从1978年开始，德丰为市场提供家用电器开关及多种工业配件而享有盛誉。

德丰拥有独特的电子元件、电器与机械上的专业技术。纵向整合制造技术广泛应用于塑胶模具、金属模型、电镀、线圈、通孔插装及表面贴装电子组装。德丰从专业设计到生产高质量产品、具有最快的周转期和价格优势，忠诚地为客户提供全方位解决方案。



# Facilities 设施

Total Site Area : 300,000m<sup>2</sup>

Production Floor Space : 150,000m<sup>2</sup>

Accreditation : ISO 9001:2008  
ISO 13485:2007  
ISO 14001  
ISO 17025  
TS 16949  
FDA-registered manufacturing site

Major Businesses : Switches (Mechanical and Electro-mechanical)  
Power Tools Controls  
Automotive Components  
Electronic Manufacturing Services (EMS)  
Fluid Control Components

Stamping Shop : 100 Presses  
High Speed Precision Press  
Multi-Slide Forming Machines  
CNC Integrated Stamping/ Welding Station  
Hydrocarbon de-oil cleaning line

Molding Shop : Injection Machines  
Electrical Molding Machine  
Vertical Molding Machine  
Central Material Drying and Feeding System  
Coordination Measuring Machine





Tool Shop : CNC High Speed Machining Centers  
CNC High Speed Graphite Center  
CNC Wire Cut Machines  
CNC EDM  
CNC Lathes (4-1/2 axis)  
CNC High Precision Optical Profile Grinders  
CNC High precision Surface Grinder  
CNC High Precision Jig Grinder  
CNC Precision Cylindrical Grinder  
CAD/ CAM/ CAD System  
Coordination Measuring Machine

Electronics Assembly : SMT Lines  
Lead Free Wave Solder Lines  
AOI, X-ray, ICT

Metrology Lab : CMM  
X-Ray Scanners  
Optical Measuring Systems  
1000 x Optical Microscope  
Goniophotometer  
Spectroradiometer  
Digital Hardness Meter (Portable type)

Test Lab : Safety Standard Approval Test Lab  
- UL and DEMKO Certified  
Electrical & Mechanical Test - Endurance Test  
Environmental Test  
EMC Lab (Pre-Compliance)  
Photometric Lab

Assembly : Automatic, Semi Automatic, Manual Production Lines and  
Cell Lines



# History 发展历程

- 恒生泛珠三角环保大奖 **2014** • Hang Seng Pan Pearl River Delta Environmental Awards
- 广东制造业500强 (广东省制造业协会/社会科学院评选) **2013** • Top 500 Manufacturing Companies in Guangdong (Accredited by Guangdong Manufacturers Association / Academy of Social Sciences)
- UL亚太第一家UL61058 CTPD认可实验室 **2011** • First Company acquired UL 61058 CTPD in Asia Pacific Regions
- 成立新厂房于东莞长安，扩展电子产品生产服务 **2011** • Set up EMS Factory in Chang An, Dongguan
- 全国质量活动优秀企业奖 (中国机械工业质量管理协会/机冶建材工会全国委员会/中国机械产业文化协会评选) **2008** • Excellent Enterprise Quality Award in China (China Machine Building Quality Management Association / Metallurgical and Building Materials Workers' Union / China Association of Machinery Industry Culture)
- 首次得到UL61058认证电动开关 **2007** • First UL61058 approved power tool switches
- 取得 ISO 13485证书 **2007** • ISO 13485 certified
- 取得TS16949证书 **2006** • TS16949 certified
- 收购BJ Automotive GmbH **2006** • Acquisition of BJ Automotive GmbH
- 取得 ISO14001证书 **2005** • ISO 14001 certified
- 收购意大利ODE有限公司 **2004** • Acquisition of ODE, S.r.l., Italy
- 取得 ISO17025证书 **2004** • ISO 17025 certified
- 收购德国Kautt & Bux公司 **2000** • Acquisition of Kautt & Bux, Germany
- 取得 ISO9000证书 **1996** • ISO 9000 certified
- 开始PCBA为第三业务 **1996** • Start PCBA (printed circuit board assembly) as third product area
- 推出电子产品生产服务 **1995** • Started EMS (Electronics Manufacturing Service)
- 开始于中国东莞市洪梅镇成立首间厂房 **1984** • Started first factory in Hongmei, Dongguan
- 首次获得UL认证开关 **1980** • First UL approved switches
- 公司创始 **1978** • Company established



# How to Select ? 如何选择开关?



## What are your considerations?

To select an appropriate switch for a particular application, many different factors should be considered:

- 1) Switch type:**  
Which type of the switch you prefer? Slide or Rocker switch? In general, there are 7 types of switch: Slide, Rocker, Rotary, Micro, Push button, Keyboard and Toggle Switch. It is depended on the activating way of the appliance you chosen.
- 2) Safety Mark:**  
Choose UL, IEC or CQC marking? You should consider which market you sell to. See detail in "Safety Mark".
- 3) Current:**  
Low current or high current? You can choose the suitable current to match the Circuit / Current of your product. **Generally, there are 2 Kind of current control levels: Signal Level (below 100mA) and Power Level (equal or above 100mA).** For Signal Level current, some special designs of Contacts are the solution of this low current rating. A high rating switch maybe not suitable for a rating which is less than 100mA of circuit. Please contact us for detail.
- 4) Endurance:**  
How long of the appliance life? Basic 6000 (UL), 10000 (IEC) or longer cycles? You can choose the suitable endurance according to the product. See detail in "Meaning of Rating on the Switch".
- 5) Temperature:**  
Will the switch work at -25 to 55°C or more special temperature environment? You can choose the suitable temperature according to the rating. See detail in "Meaning of Rating on the Switch".
- 6) Dust and Water proof:**  
Will the switch contact water or will work at dusty area? You can choose the suitable dust and water proof level according to the IP mark. See detail in "Meaning of Rating on the Switch" and "Table A". \* IP mark for ENEC or CQC only.
- 7) Glow Wire Test:**  
Do the plastic material of the switch require to pass GWT requirement? See detail in "Glow Wire Test".

## 你有什么考虑因素?

为特定的应用要求而去选择适合的开关需要考虑许多不同因素:

- 1) 开关类型:**  
您喜欢哪一种开关类型? 滑动开关或翘板开关? 在一般情况下, 有7种开关: 滑动、翘板、旋转、微动、按钮、琴键和拨动开关。这是取决于您选择的产品启动的方法。
- 2) 认证标志:**  
选择UL、IEC或CQC标志? 你应该考虑计划的销售市场。参见“认证标志”的细节。
- 3) 电流:**  
低电流或大电流? 你可取决于产品的实际电路/电流。**一般来说有两个电流级别: 信号级别(低于100mA)和功率级别(等于或超过100mA的)。**在信号级别下, 一些特殊设计的“触点”可以适合这些低额定的电流。一些较大规格也许并不适合开关规格是低于100mA的电路。详情请与我们联系。
- 4) 寿命:**  
产品的使用寿命要多长? 基本6000(UL)、10000(IEC)或更长周期? 你可以根据产品而选择合适的开关寿命。参见“认识开关的规格”的细节。
- 5) 温度:**  
开关将会工作在-25至55°C, 或更特别温度环境吗? 你根据开关规格可以选择合适的温度。参见“认识开关的规格”的细节。
- 6) 防尘和防水:**  
开关接触水或将工作在尘土飞扬的地方? 你根据IP标记标记可以选择合适的防尘和防水等级。参见“认识开关的规格”和“Table A”的细节。\* IP标记只适用于ENEC或CQC。
- 7) 灼热丝试验**  
开关塑料需要GWT的要求? 参见“灼热丝试验”的细节。

# How to Select ? 如何选择开关?

## Meaning of Rating on the Switch :

### ► In IEC (ENEC) rating **10(6)A 250V~ 5E4 T125/55 $\mu$ IP30 APM-2116**

10(6) : The rated current for resistive load = 10A. The rated current for motor = 6A. The inrush current = 6 x the rated current for motor.

5E4 : The rated operating cycles = 50,000 cycles; If operating cycle rating is absent on the switch, default operating cycles = 1E4, 10,000 cycles.

T125/55: T125 means the rated ambient temperature for the switch body is 125 °C, 55 means the rated ambient temperature for the actuating member.  
\* For T85 only, it means the rated ambient temperature is from 0 °C up to 85 °C.

#### \* Optional mark :

$\mu$  : The mark is for micro-disconnection of switches. There should be “ $\mu$ ” mark on switch when the clearance and dielectric strength of disconnection can't comply with the requirement of basic insulation

IP30 : IP index. It complies protection against ingress of solid foreign objects and water (See Table A).

APM-2116 : Model Type No. on the IEC certificate.

\* CQC rating refers to IEC rating.

### ► In UL rating **20A 125VAC, 10A 250VAC 1/2HP 125-250VAC T85**

1/2HP: For circuits for North American horsepower load (hp), the fractional hp value designation is followed by the symbol “hp”. 1/2HP means 1/2 Horsepower load. Please see Table B of the full load and overload-test current for a.c. and d.c. horsepower.

T85 : The rated ambient temperature is from 0 °C up to 85 °C. If T mark is not given, for mechanical switches and electronic switches, the implied ambient temperature range is from 0 °C up to 55 °C.

Endurance cycle : If endurance cycle mark is not given, the implied endurance cycles is 6,000 cycles.

UL Catalogue No.: According to UL1054 standard, is not necessary to be marked it on the switch when it is impractical to mark.

## 认识开关的规格 :

### ► IEC (ENEC)认证的规格 **10(6)A 250V~ 5E4 T125/55 $\mu$ IP30 APM-2116**

10(6) : 括号前的10A值指的是开关能承受的额定电流，括号里的6A值是指开关能承受的马达负载的稳态电流，冲击电流为6倍稳态电流。

5E4 : 开关的使用寿命为50,000次，当没有注明寿命次数，默认为1E4，即10,000次。

T125/55 : T125是指开关装置于产品的内部所承受之基本温度上限。55是指开关装置于产品外露所承受之基本温度上限。  
\* 有些只展示T85即表示整个开关所承受的基本温度由0度至85度。

#### \* 附加标签 :

$\mu$  : “微断开”标志，当开关断开电气间隙及高压在不能满足一个基本绝缘的要求时，就必须带有“微断开”标志。

IP30 : 防尘防水标志 (详见表A)。

APM-2116 : IEC认证的认证编号。

\* CQC 认证规格参考 IEC 认证。

### ► UL认证的规格 **20A 125VAC, 10A 250VAC 1/2HP 125-250VAC T85**

1/2HP: 表示开关能过1/2HP的马力负载，具体马力负载的稳态电流及冲击电流对应关系见附表B。

T85 : 温度标志，表示开关能在0度至85度的环境中使用，但UL marking不一定会标出温度标志。当没有注明时，默认为0度至55度。

操作寿命 : UL无寿命次数标志时，默认为6,000次。

UL的认证编号 : UL的认证编号不一定要标出。





**Table A: Degree of protection against solid foreign objects and water:**

Degree of protection against solid foreign objects		防尘标志
<b>IP0X</b>	Non-protected against solid foreign objects	不防尘
<b>IP1X</b>	Protected against solid foreign objects of 50 mm diameter and greater	防直径不小于50mm固体异物
<b>IP2X</b>	Protected against solid foreign objects of 12.5 mm diameter and greater	防直径不小于12.5mm固体异物
<b>IP3X</b>	Protected against solid foreign objects of 2.5 mm diameter and greater	防直径不小于2.5mm固体异物
<b>IP4X</b>	Protected against solid foreign objects of 1.0 mm diameter and greater	防直径不小于1.0mm固体异物
<b>IP5X</b>	Dust-protected	防尘的
<b>IP6X</b>	Dust-tight	尘密的
Degree of protection against ingress of water		防水标志
<b>IPX0</b>	Non-protected against ingress of water	不防水
<b>IPX1</b>	Protected against vertically falling water drops	防垂直滴水
<b>IPX2</b>	Protected against vertically falling water drops when enclosure tilted up to 15°	防外壳 15° 内倾侧·铅垂滴水
<b>IPX3</b>	Protected against spraying water	防淋
<b>IPX4</b>	Protected against splashing water	防溅
<b>IPX5</b>	Protected against water jets	防喷
<b>IPX6</b>	Protected against powerful water jets	防强烈喷水
<b>IPX7</b>	Protected against the effects of temporary immersion in water	防短时浸水

**Table B: The Table of the Full Load and Overload Test Current for a.c. and d.c Horsepower:**  
马力负载的稳态电流及冲击电流对应关系

	AC 交流				DC 直流			
	Full-load(A) 满负载(安培)		Overload(A) 过载(安培)		Full-load(A) 满负载(安培)		Overload(A) 过载(安培)	
	125V	250V	125V	250V	125V	250V	125V	250V
1/4 HP	5.8	2.9	34.8	17.4	3	1.5	30	15
1/3 HP	7.2	3.6	43.2	21.6	3.8	1.8	38	19
1/2 HP	9.8	4.9	58.8	29.4	5.4	2.7	54	27
3/4 HP	13.8	6.9	82.8	41.4	7.4	3.7	74	37
1 HP	16	8	96	48	9.6	4.8	96	48

**Safety Mark:**

Generally, each country recognized their national safety mark only (For example, UL mark for US, ENEC mark for most Europe countries, and CQC for China) as their safety requirements. Unless your end product/appliance is planning to use a non-approval switch for specific market/application, the safety mark on Defond switch is able to help you to fulfill the national safety requirements for your end product/appliance.

**认证标志：**

基本上，每一个国家只会认可其国家的安全标志来满足其国家的安全要求，如去美国的选UL，去欧洲的选IEC，国内用CQC标志。除非你计划用非认证的开关用于特定市场//家电的产品外，德丰开关上的安全标志能够帮助你实现你的产品/家电的国家安全要求。



# How to Select ? 如何选择开关?

## Glow Wire Test(GWT):

The requirement of GWT should be selected reasonably for plastics. According to the below requirement from IEC60335-1, only for unattended appliances which carrying a current exceeding 0.2 A is required to withstand the GWT 750°C without ignition( $\leq 2S$ ). Other appliances such as handheld hairdryer is just required to withstand the GWT 750/30S .

## 灼热丝测试：

要合理选择对塑胶材料GWT的要求。从以下IEC60335-1对塑胶材料的要求可知，只有无人照看且大于0.2A的器具才需要750°C/ $\leq 2S$ ，其余像手持式风筒等只需要过750°C/30S灼热丝测试即可。

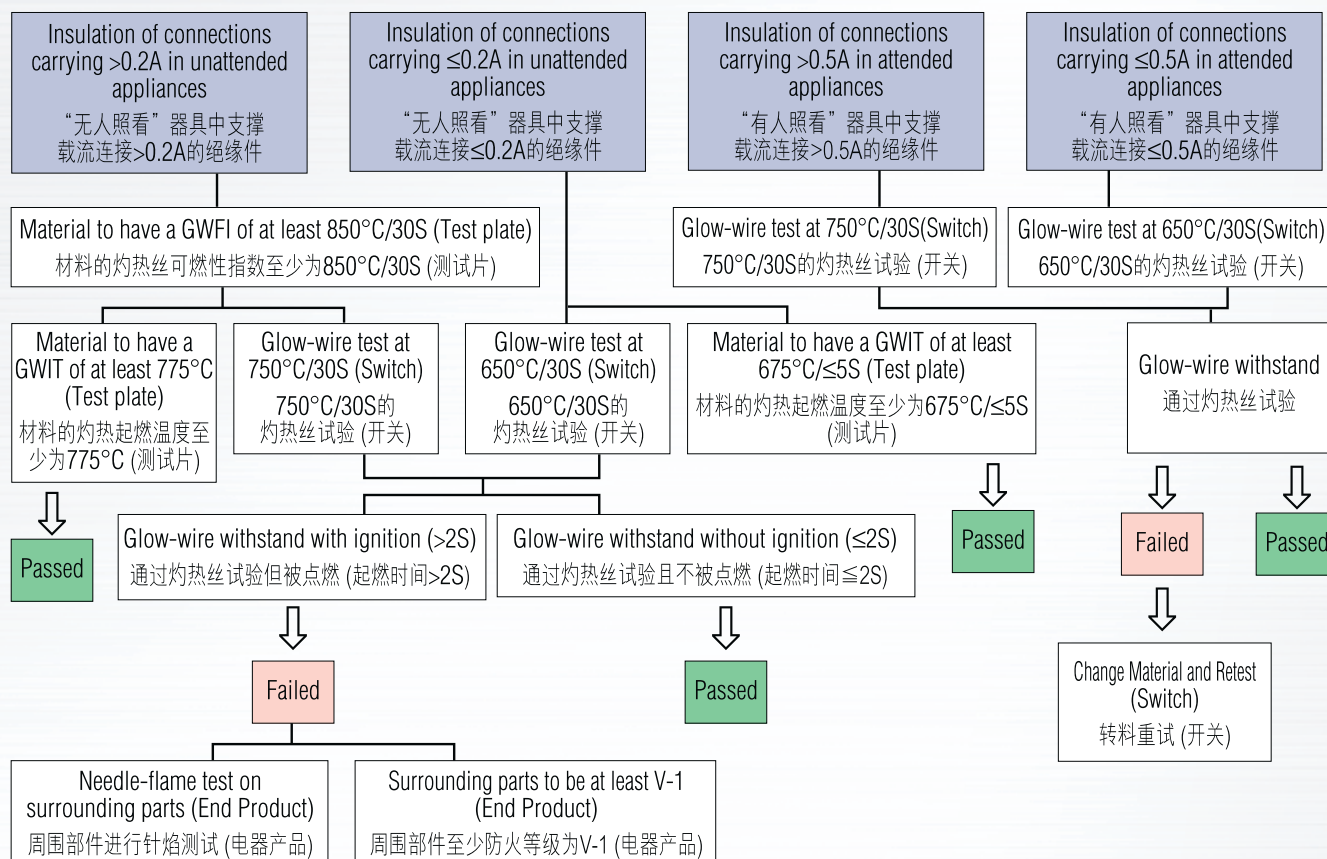



# Safety Marking 安全标识



All safety marking of European countries are harmonized into one ENEC marking

AENOR (Spain)	VDE (Germany)	MEEI (Hungary)
SGS Belgium - Division SGS CEBEC (Belgium)	OVE (Austria)	ITCL (Intertek) (United Kingdom)
IMQ (Italy)	BSI (United Kingdom)	EZÚ (Czech republic)
CERTIF (Portugal)	Electrosuisse (Switzerland)	SIQ (Slovenia)
KEMA (Netherlands)	Intertek Semko (Sweden)	TSE (Turkey)
SNCH (Luxembourg)	UL International Demko (Denmark)	TRLP (TUV) (Germany)
LCIE (NF mark) (France)	SGS Fimko (Finland)	TÜV SÜD PS (TUV) (Germany)
ELCT ELOT (Greece)	NEMKO (Norway)	PREDOM-OBR (Poland)



UL Recognized Component for both the United States and Canada



UL Recognized Component for Canada



UL Recognized Component for the United States



CQC Recognized Component and Product Mark for China

## UL61058 status @ Defond

- The standard of UL1054 for Special Use Switches will be withdrawn on June 23, 2015. After that, only UL61058 will be used for the evaluation of switches.
- Existing certifications to UL 1054 will be allowed to continue to be certified and not be withdrawn after June 23, 2015
- Over 40 series of switch have been qualified UL61058 since 2007 that cover Home Appliances and Power Tool segments.
- Defond is the 1st company in Asia Pacific regions obtained the CTD (Client Test Data Program) for Switch for Appliances - UL61058. That means UL will take Defond test report directly and Defond has the comparative advantage in obtaining new approval.
- 特殊用途开关标准UL1054将于2015年6月23日被撤销。之后，UL将只会用UL61058开关标准作评估。
- 现有已取得的UL1054认证将会继续容许被使用，同时不会在2015年6月23日被撤销。
- 自2007年以来，德丰已经有四十多种系列，涵盖家电和电动工具领域的开关，获得UL61058认证。
- 此外，德丰是亚太地区的第一家公司获得的UL61058 CTD (客户测试数据计划)。这意味著，UL将直接采取德丰测试报告，而德丰因此更具优势获得新的认证批准。



# Standard Model Index 标准索引

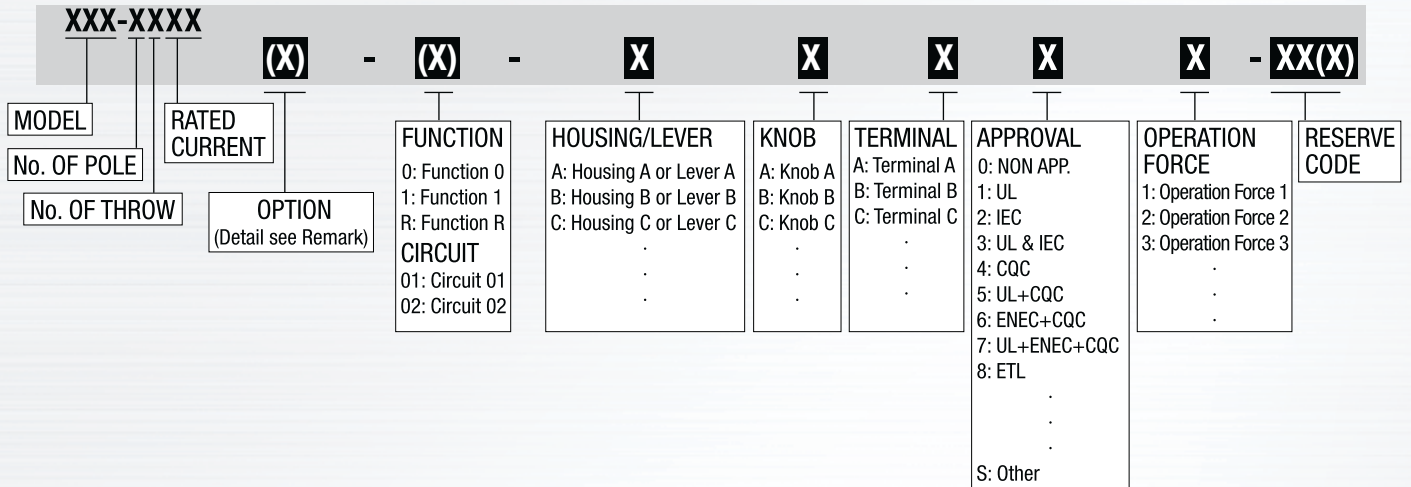

Remark:

1. Item with bracket is optional
2. The first bracket indicates option of wire, disconnection type, proofed water or temperature etc.

## Example A CRE - 1115W - 0 - AAS32 - 02R :

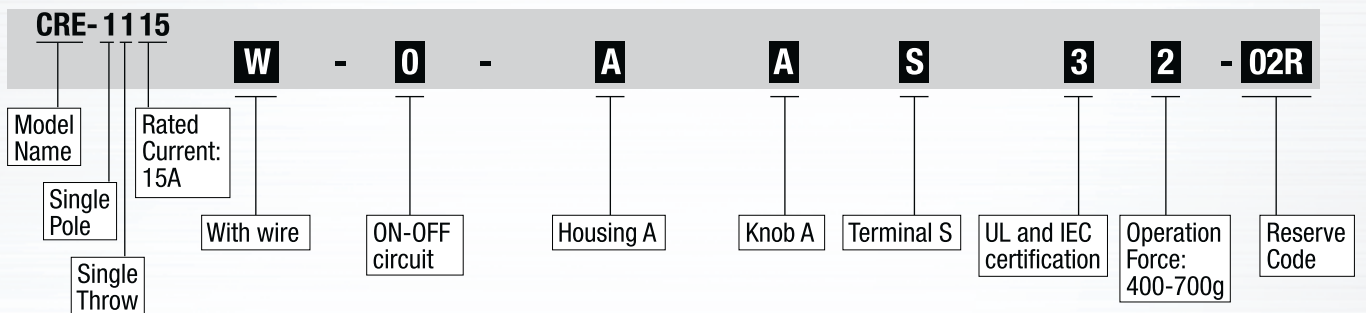

## Example B CRT - 1215 - Y - BCD13 - 03R :

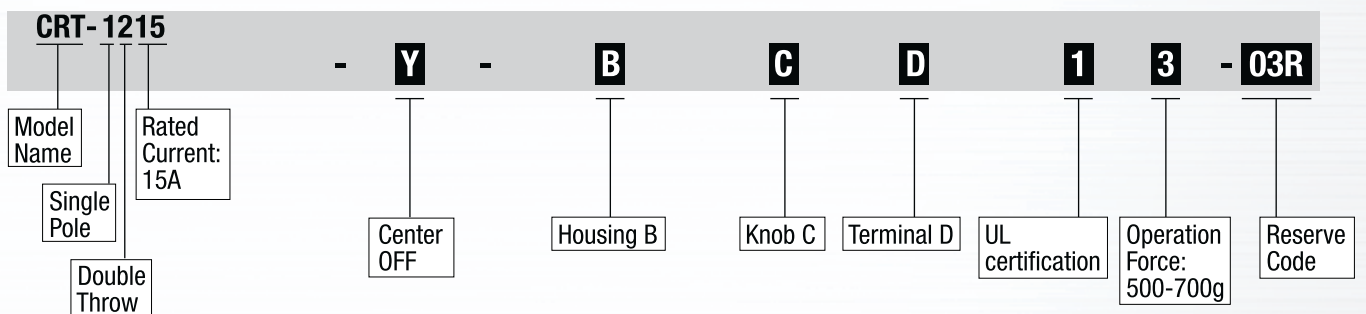



**Slide Switch 滑动开关**



2-13

**Rocker Switch 翘板开关**



14-29

**Rotary Switch 旋转开关**

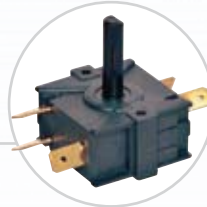

30-37

**Micro Switch 微动开关**



38-45

**Push Button Switch 按钮开关**

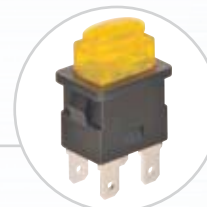

46-55

**Keyboard Switch 琴键开关**



56-60

# PUSH BUTTON SWITCH

## 按钮开关

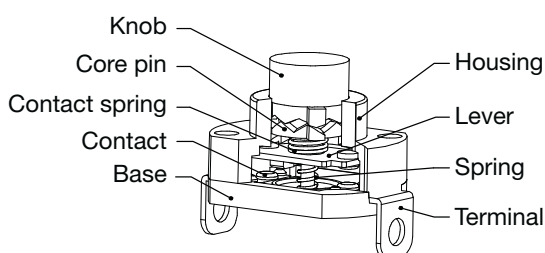
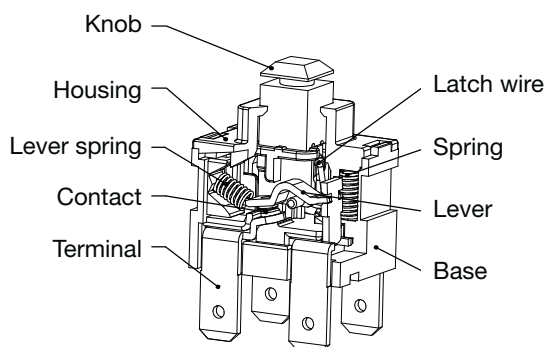

### Switch Features 特征

1. Self lock and non self lock function available  
按钮开关按结构可分为自锁与非自锁两种形式
2. A higher travel distance of Push Button Switch than that of Micro Switch  
相对微动开关，按钮开关的行程较大
3. Neon and LED lamp available  
按钮开关可带氖灯或LED灯
4. Simple circuit available (mainly for ON/OFF, ON/ON, OFF/ON/ON)  
电路变化简单，主要为ON/OFF、ON/ON、OFF/ON/ON
5. Protection cover for dust and water proof available  
可加防护外罩，达到防尘防水功能

### Tips 提示

1. Please pay attention of the operating travel distance and position of self lock.  
必需注意按钮开关操作行程及自锁开关的过档位置。
2. Normal Close Push Button Switch is not suitable for a high vibration working area.  
常闭式按钮开关不适合用于较大震动的电器产品。
3. The duration and temperature of welding and wave soldering are critical. Generally, the wattage of the soldering iron is 50~70W, the duration of welding is within 3 second, the duration of wave soldering is 3~4 second and the chamber temperature is below 260°C.  
焊线或过波峰炉时必需注意温度及时间。焊线选用50~70瓦的恒温铬铁，上锡时间控制在3秒以内，过波峰炉时间控制在3~4秒，炉温控制在260度以下。





# CPU



- single / double pole, single throw latching or momentary-on
- ratings
  - 13A 125VAC, 6.5A 250VAC T105/T65
  - 12(10)A 250VAC 1E4 T105
  - 6(6)A 250VAC 5E4 T105 for CPU-1113
  - 10(2)A 250VAC 1E4 T105 for CPU-2113

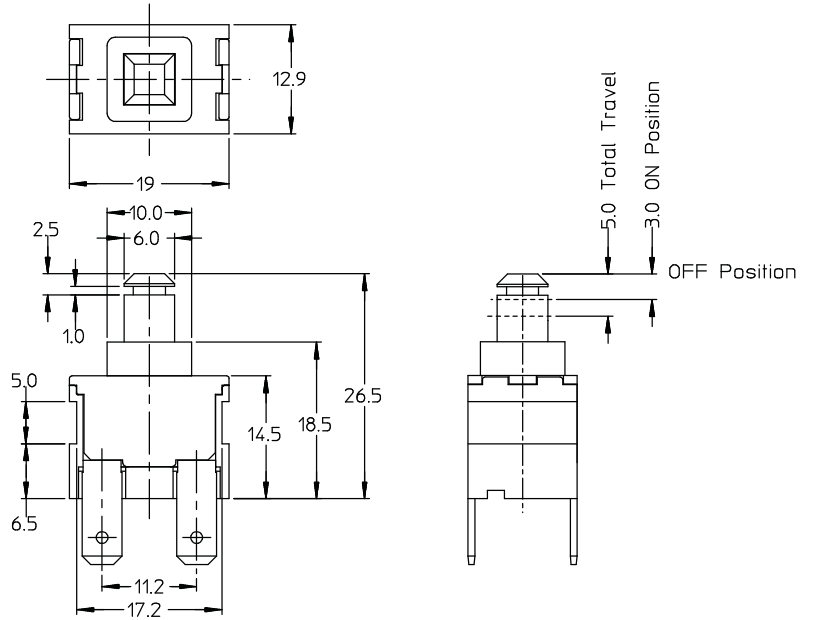

## CPU-XXXX

- **X** - **X** **X** **X** **X** **X** - **XXX**

O	OFF	ON
R	OFF	Momentary ON

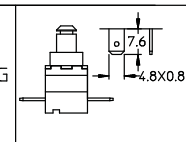
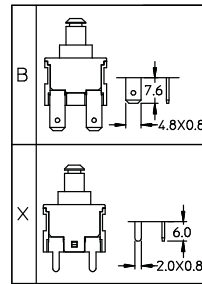
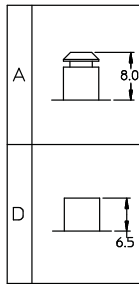
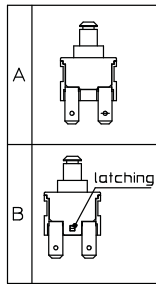

1	1.25±0.35Kgf
2	0.6±0.25Kgf For SPST only