

## RS1AGR THRU RS1MGR

### 1.0AMP. FAST RECOVERY SURFACE MOUNT RECTIFIERS

#### FEATURE

- . Fast switching
- . High current capability
- . Low forward voltage drop
- . Low power loss, high efficiency
- . High surge capability
- . High temperature soldering guaranteed:  
260°C/10 seconds at terminals.
- . For surface mounted application.
- . Easy pick and place.

#### MECHANICAL DATA

- . Terminal: Solder plated
- . Case: Molded with UL-94 Class V-0 recognized  
Flame Retardant Epoxy
- . Polarity: color band denotes cathode
- . Weight: 0.073 grams

#### SMA (DO-214AC)

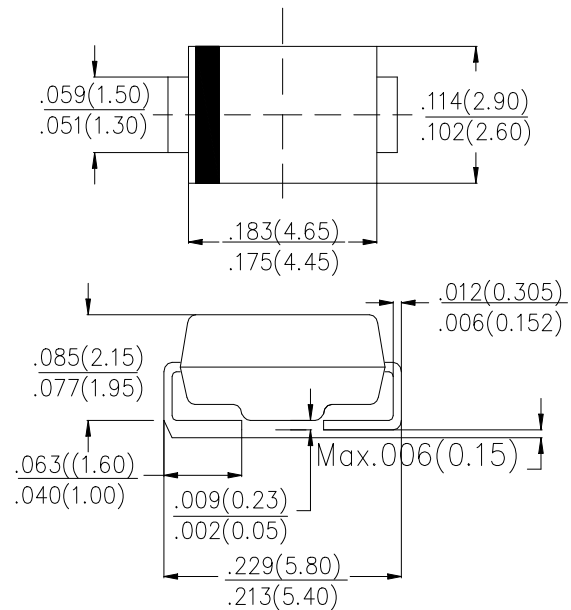

Dimensions in inches and (millimeters)

### MAXIMUM RATINGS AND ELECTRICAL CHARACTERISTICS

Ratings at 25°C ambient temperature unless otherwise specified.

Single phase, half wave, 60Hz, resistive or inductive load. For capacitive load, derate current by 20%

Type Number	SYM BOL	RS1A GR	RS1B GR	RS1D GR	RS1G GR	RS1J GR	RS1K GR	RS1M GR	units
Maximum Recurrent Peak Reverse Voltage	$V_{RRM}$	50	100	200	400	600	800	1000	V
Maximum RMS Voltage	$V_{RMS}$	35	70	140	280	420	560	700	V
Maximum DC blocking Voltage	$V_{DC}$	50	100	200	400	600	800	1000	V
Maximum Average Forward Rectified Current	$I_{F(AV)}$	1.0							A
Peak Forward Surge Current 8.3ms single half sine- wave superimposed on rated load (JEDEC method)	$I_{FSM}$	30.0							A
Maximum Forward Voltage at 1.0A DC	$V_F$	1.3							V
Maximum DC Reverse Current @ $T_J=25^\circ\text{C}$ at rated DC blocking voltage @ $T_J=125^\circ\text{C}$	$I_R$	5.0 100.0							$\mu\text{A}$
Maximum Reverse Recovery Time (Note 1)	$t_{rr}$	150				250	500		nS
Typical Junction Capacitance (Note 2)	$C_J$	10							pF
Typical Thermal Resistance (Note 3)	$R_{(JA)}$	85							$^\circ\text{C}/\text{W}$
Storage Temperature	$T_{STG}$	-55 to +150							$^\circ\text{C}$
Operation Junction Temperature	$T_J$	-55 to +150							$^\circ\text{C}$

#### Note:

1. Test Conditions:  $I_F=0.5\text{A}$ ,  $I_R=1.0\text{A}$ ,  $I_{RR}=0.25\text{A}$
2. Measured at 1.0 MHz and applied reverse voltage of 4.0Vdc
3. Measured on P.C.Board with  $0.2 \times 0.2'' (5.0 \times 5.0\text{mm})$  Copper Pad Areas.

**RATING AND CHARACTERISTIC CURVES (RS1AGR THRU RS1MGR)**

FIG.1-TYPICAL FORWARD CURRENT DERATING CURVE

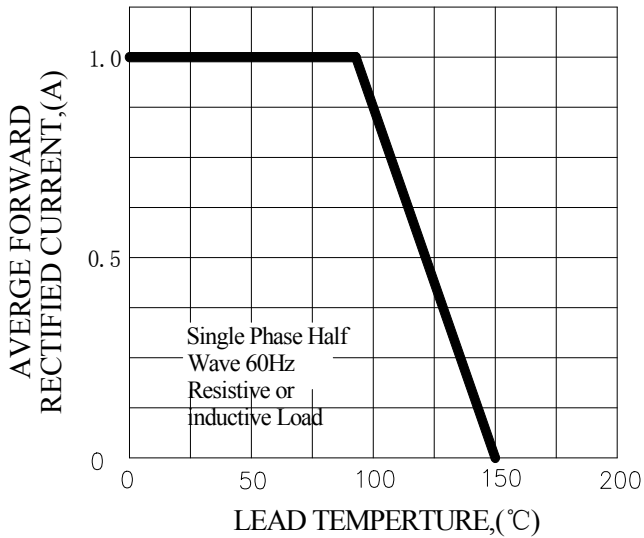

FIG.2-TYPICAL INSTANTANEOUS FORWARD CHARACTERISTICS

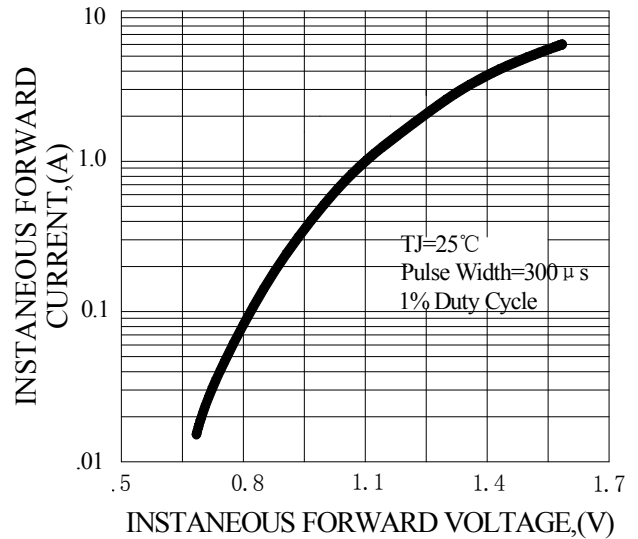

FIG.3-MAXIMUM NON-REPETITIVE FORWARD SURGE CURRENT

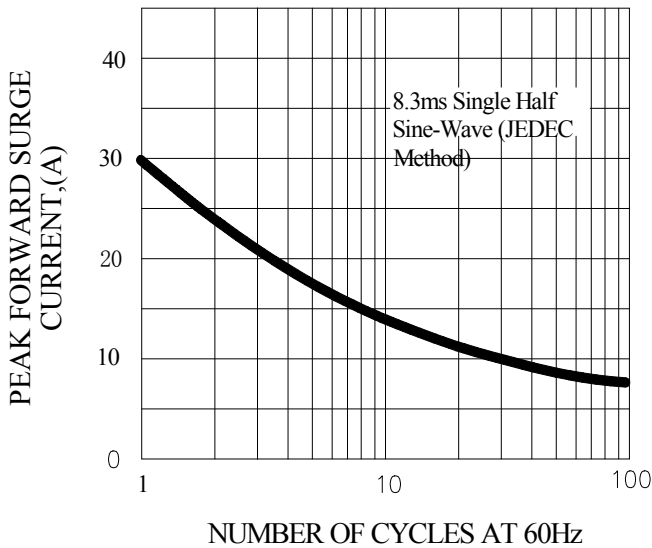

FIG.4-TYPICAL REVERSE CHARACTERISTICS

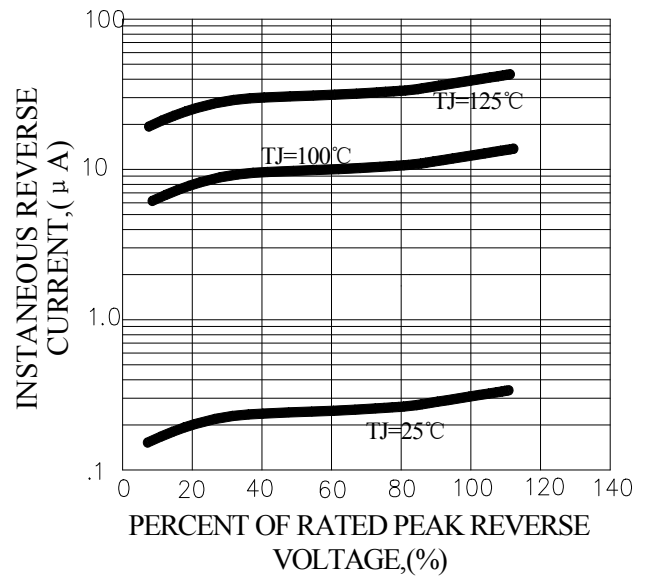
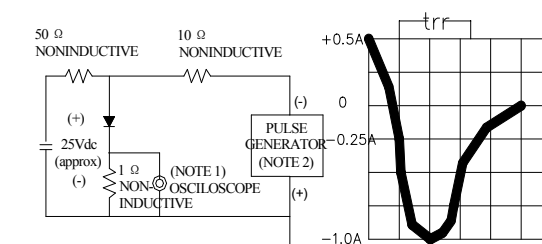

FIG.5-TEST CIRCUIT DIAGRAM AND REVERSE RECOVERY TIME CHARACTERISTIC



NOTES: 1. Rise Time=7ns max, Input Impedance=1 megohm.22pF.  
2. Rise Time=10ns max, Source Impedance= 50 ohms.

## Marking and packaging illustration

### 1、Marking

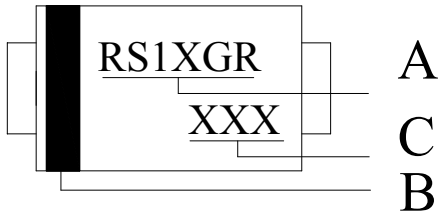

SYMBOL	explanation
<b>A</b>	Product name, X: A, B...M
<b>B</b>	Color Band Denotes Cathode
<b>C</b>	Date code

### 2、Packaging

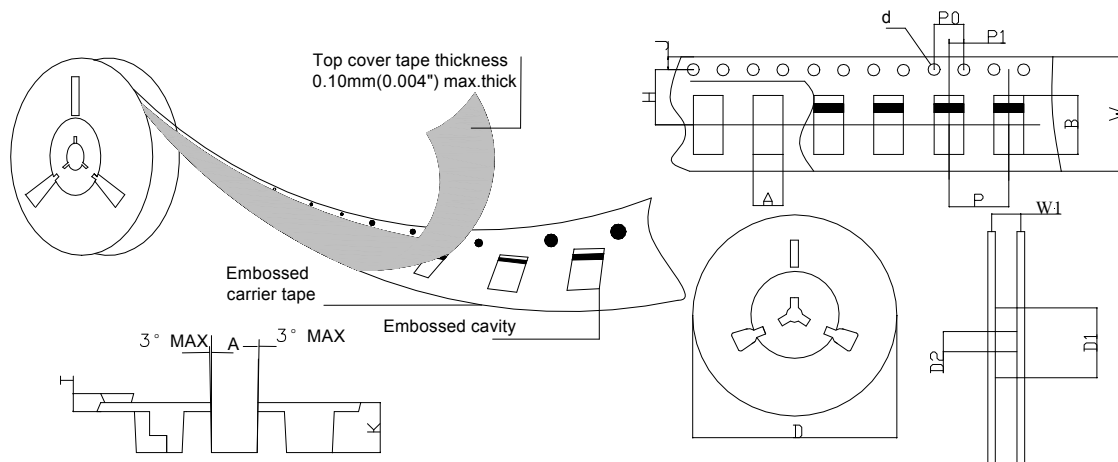

SPECIFICATIONS mm(inch)		PACKAGE
SYMBOL		SMA(DO-214AC)
ITEM		
Carrier width	A	3.17(0.125)Max
Carrier length	B	5.35(0.232)Max
Sprocket hole	d	ø1.55(0.061)Typ
Reel outer diameter	D	330.0/178.0(13/7)Typ
Reel inner diameter	D1	50.0(1.969)Min
Feed hole diameter	D2	13.0(0.512)Typ
Sprocket hole position	J	1.75(0.069)Typ
Punch hole position	H	5.55(0.219)Typ
Carrier depth	K	2.42(0.095)Typ
Punch hole pitch	P	4.00(0.157)Typ
Sprocket hole pitch	P0	4.00(0.157)Typ
Embossment center	P1	2.00(0.079)Typ
Overall tape thickness	T	0.30(0.012)Typ
Tape width	W	12.0(0.472)Typ
Reel width	W1	12.4(0.488)Min