

RS1AG THRU RS1MG

1.0AMP. FAST RECOVERY SURFACE MOUNT RECTIFIERS

FEATURE

- . Fast switching
- . High current capability
- . Low forward voltage drop
- . Low power loss, high efficiency
- . High surge capability
- . High temperature soldering guaranteed:
260°C/10 seconds at terminals.
- . For surface mounted application.
- . Easy pick and place.

MECHANICAL DATA

- . Terminal: Solder plated
- . Case: Molded with UL-94 Class V-0 recognized
Flame Retardant Epoxy
- . Polarity: color band denotes cathode
- . Weight: 0.073 grams

SMA (DO-214AC)

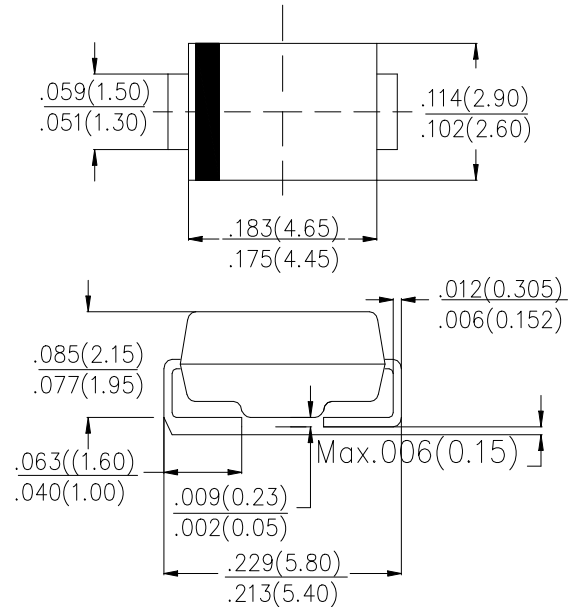

Dimensions in inches and (millimeters)

MAXIMUM RATINGS AND ELECTRICAL CHARACTERISTICS

Ratings at 25°C ambient temperature unless otherwise specified.

Single phase, half wave, 60Hz, resistive or inductive load. For capacitive load, derate current by 20%

Type Number	SYM BOL	RS1A G	RS1B G	RS1D G	RS1G G	RS1J G	RS1K G	RS1M G	units
Maximum Recurrent Peak Reverse Voltage	V_{RRM}	50	100	200	400	600	800	1000	V
Maximum RMS Voltage	V_{RMS}	35	70	140	280	420	560	700	V
Maximum DC blocking Voltage	V_{DC}	50	100	200	400	600	800	1000	V
Maximum Average Forward Rectified Current	$I_{F(AV)}$	1.0							A
Peak Forward Surge Current 8.3ms single half sine- wave superimposed on rated load (JEDEC method)	I_{FSM}	30.0							A
Maximum Forward Voltage at 1.0A DC	V_F	1.3							V
Maximum DC Reverse Current @ $T_J=25^\circ\text{C}$ at rated DC blocking voltage @ $T_J=125^\circ\text{C}$	I_R	5.0 100.0							μA
Maximum Reverse Recovery Time (Note 1)	t_{rr}	150				250	500		nS
Typical Junction Capacitance (Note 2)	C_J	10							pF
Typical Thermal Resistance (Note 3)	$R_{(JA)}$	85							$^\circ\text{C}/\text{W}$
Storage Temperature	T_{STG}	-55 to +150							$^\circ\text{C}$
Operation Junction Temperature	T_J	-55 to +150							$^\circ\text{C}$

Note:

1. Test Conditions: $I_F=0.5\text{A}$, $I_R=1.0\text{A}$, $I_{RR}=0.25\text{A}$
2. Measured at 1.0 MHz and applied reverse voltage of 4.0Vdc
3. Measured on P.C.Board with $0.2 \times 0.2'' (5.0 \times 5.0\text{mm})$ Copper Pad Areas.

RATING AND CHARACTERISTIC CURVES (RS1AG THRU RS1MG)

FIG.1-TYPICAL FORWARD CURRENT DERATING CURVE

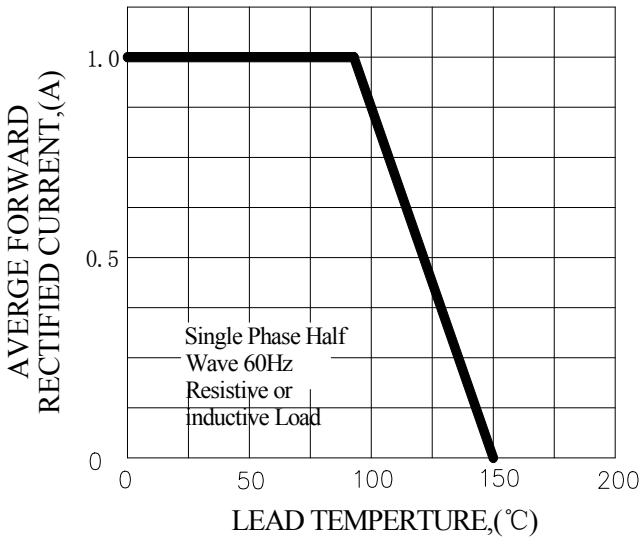

FIG.2-TYPICAL INSTANTANEOUS FORWARD CHARACTERISTICS

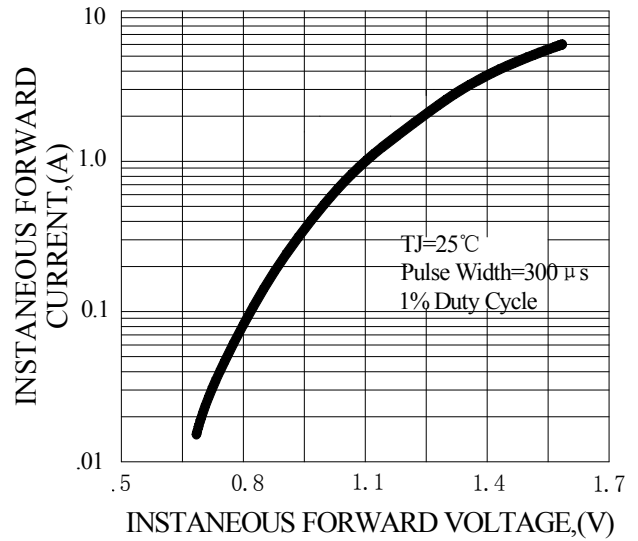

FIG.3-MAXIMUM NON-REPETITIVE FORWARD SURGE CURRENT

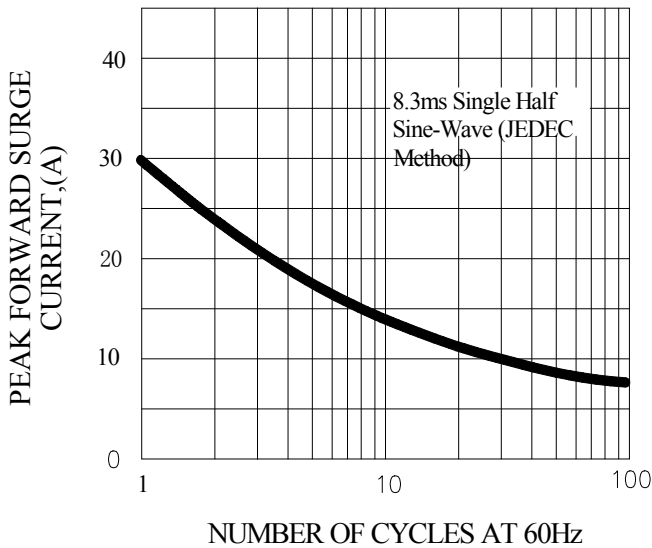

FIG.4-TYPICAL REVERSE CHARACTERISTICS

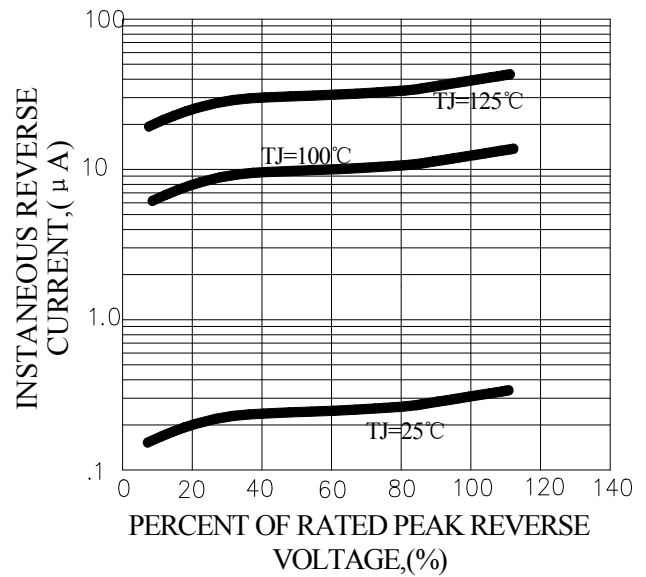
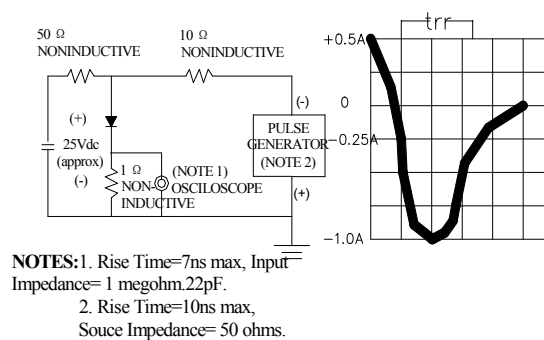
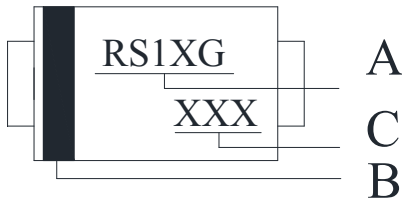

FIG.5-TEST CIRCUIT DIAGRAM AND REVERSE RECOVERY TIME CHARACTERISTIC



Marking and packaging illustration

1、Marking



SYMBOL	explanation
A	Product name, X: A, B...M
B	Color Band Denotes Cathode
C	Date code

2、Packaging

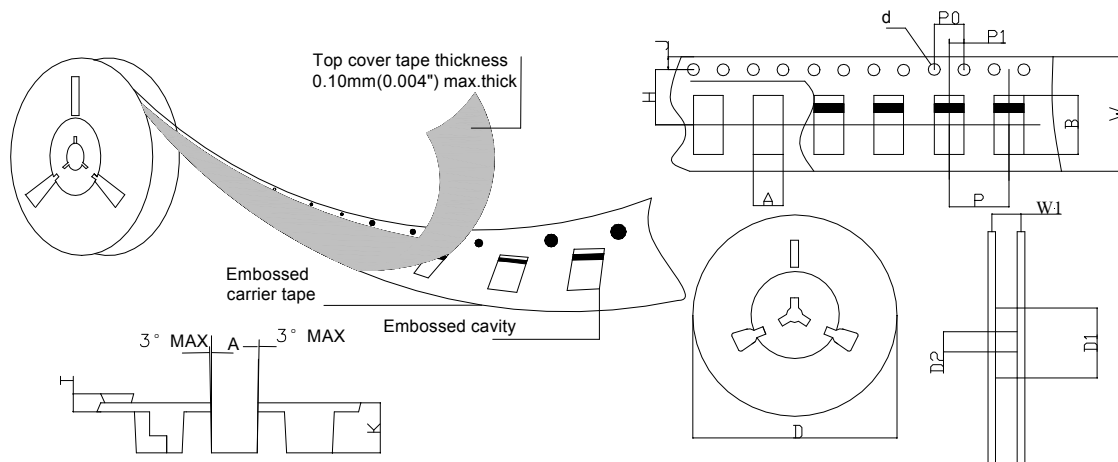

SPECIFICATIONS mm(inch)		PACKAGE
SYMBOL		SMA(DO-214AC)
ITEM		
Carrier width	A	3.17(0.125)Max
Carrier length	B	5.35(0.232)Max
Sprocket hole	d	ø1.55(0.061)Typ
Reel outer diameter	D	330.0/178.0(13/7)Typ
Reel inner diameter	D1	50.0(1.969)Min
Feed hole diameter	D2	13.0(0.512)Typ
Sprocket hole position	J	1.75(0.069)Typ
Punch hole position	H	5.55(0.219)Typ
Carrier depth	K	2.42(0.095)Typ
Punch hole pitch	P	4.00(0.157)Typ
Sprocket hole pitch	P0	4.00(0.157)Typ
Embossment center	P1	2.00(0.079)Typ
Overall tape thickness	T	0.30(0.012)Typ
Tape width	W	12.0(0.472)Typ
Reel width	W1	12.4(0.488)Min