

R2M

1.2 AMP. SURFACE MOUNT GENERAL PURPOSE FAST RECOVERY RECTIFIERS

FEATURES

- Glass passivated device
- Ideal for surface mounted applications
- Low reverse leakage
- Metallurgically bonded construction
- High temperature soldering guaranteed:
250°C /10 seconds at terminals.

MECHANICAL DATA

- Case: JEDEC SOD-123FL, molded plastic over passivated chip
- Terminals: Solder Plated, solderable per MIL-STD-750, Method 2026
- Polarity: Color band denotes cathode end
- Weight: 0.006 ounces, 0.02 gram
- Mounting position: Any

SOD-123FL

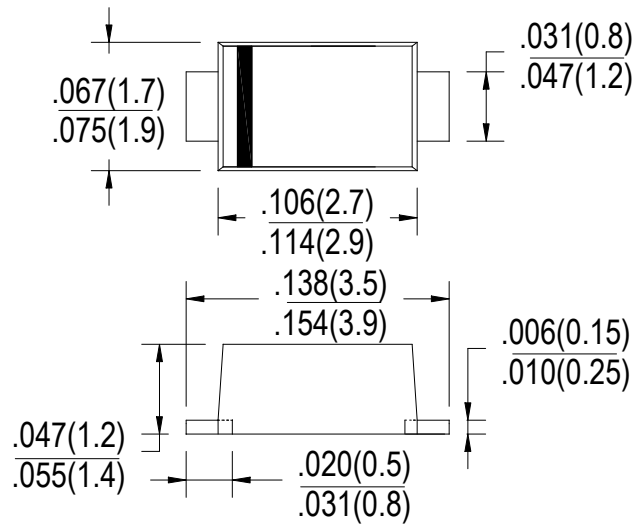

MAXIMUM RATINGS AND ELECTRICAL CHARACTERISTICS

Ratings at 25°C ambient temperature unless otherwise specified.
Single phase, half wave, 60Hz, resistive or inductive load.
For capacitive load, derate current by 20%.

Type Number	SYM BOL	R2M	units
Maximum Recurrent Peak Reverse Voltage	V_{RRM}	1000	V
Maximum RMS Voltage	V_{RMS}	700	V
Maximum DC Blocking Voltage	V_{DC}	1000	V
Maximum Average Forward rectified Current	$I_{F(AV)}$	1.5	A
Peak Forward Surge Current 8.3ms single half sine-wave superimposed on rate load (JEDEC method)	I_{FSM}	50	A
Maximum Instantaneous forward Voltage at 1.5A DC	V_F	1.3	V
Maximum DC Reverse Current @ $T_j=25^\circ\text{C}$ at rated DC blocking voltage @ $T_j=125^\circ\text{C}$	I_R	5.0	μA
		100.0	
Maximum Reverse Recovery Time (Note 1)	t_{rr}	500	nS
Typical Junction Capacitance (Note 2)	C_j	15	pF
Typical thermal resistance (Note 3)	$R_{(JA)}$	85	$^\circ\text{C}/\text{W}$
Storage Temperature Range	T_{STG}	-55 to +150	$^\circ\text{C}$
Operation Temperature Range	T_j	-55 to +150	$^\circ\text{C}$

Note: 1. Test Conditions: $I_F=0.5\text{A}$, $I_R=1.0\text{A}$, $IRR=0.25\text{A}$
2. Measured at 1MHz and applied reverse voltage of 4.0 volts d.c.
3. Measured on P.C.Board with $0.2\times 0.2''(5.0\times 5.0\text{mm})$ Copper Pad Areas

RATING AND CHARACTERISTIC CURVES (R2M)

FIG.1-TYPICAL FORWARD CURRENT DERATING CURVE

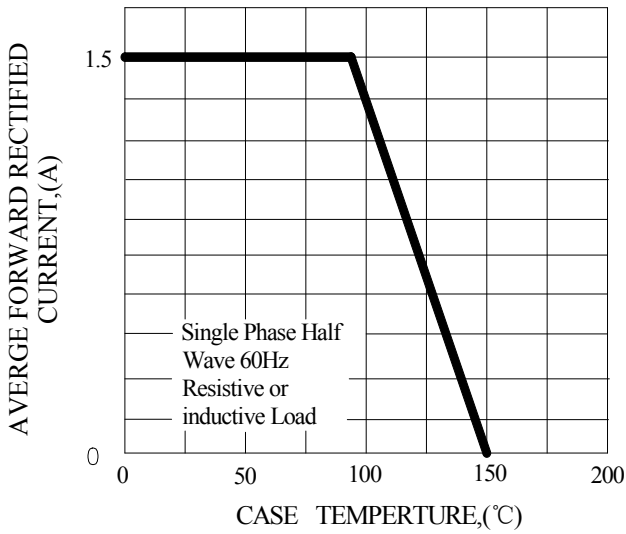

FIG.2-TYPICAL INSTANTANEOUS FORWARD CHARACTERISTICS

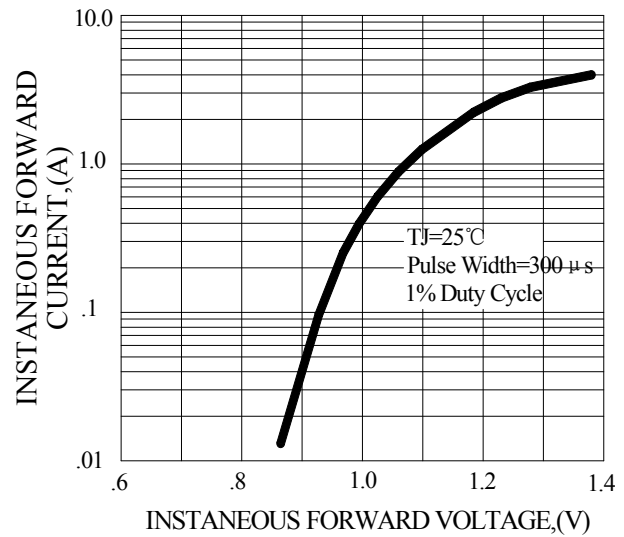

FIG.3-MAXIMUM NON-REPETITIVE FORWARD SURGE CURRENT

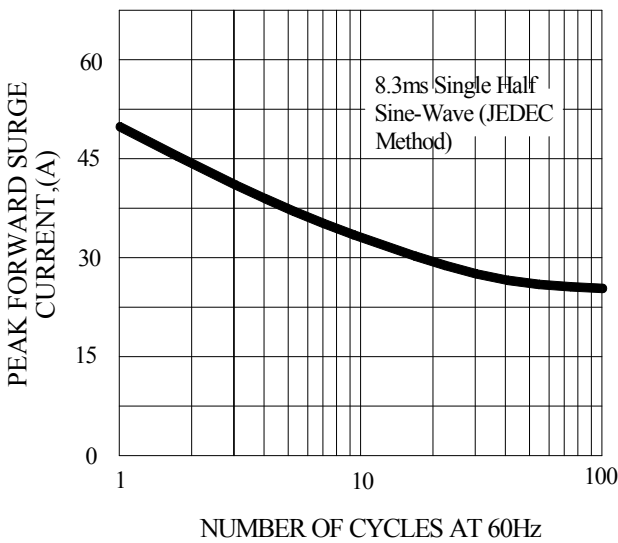

FIG.4-TYPICAL REVERSE CHARACTERISTICS

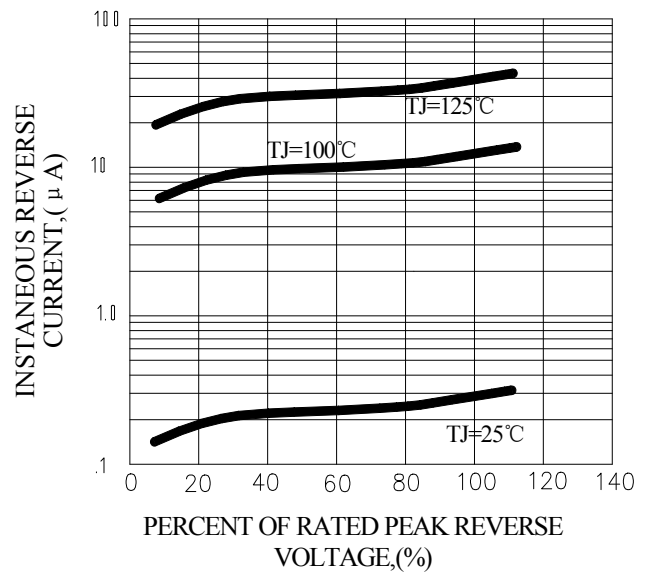
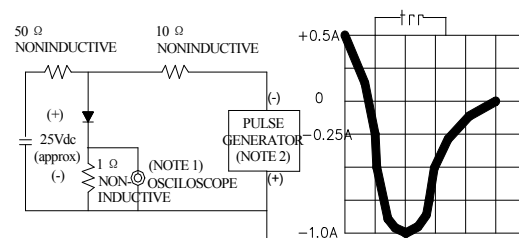

FIG.5-TEST CIRCUIT DIAGRAM AND REVERSE RECOVERY TIME CHARACTERISTIC



NOTES:1. Rise Time=7ns max, Input Impedance= 1 megohm,22pF.
2. Rise Time=10ns max, Source Impedance= 50 ohms.

Marking and packaging illustration

1、Marking

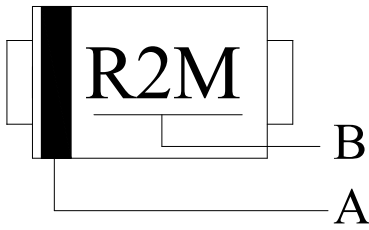

SYMBOL	Explanation
A	Color Band Denotes Cathode
B	Product Name

2、Packaging

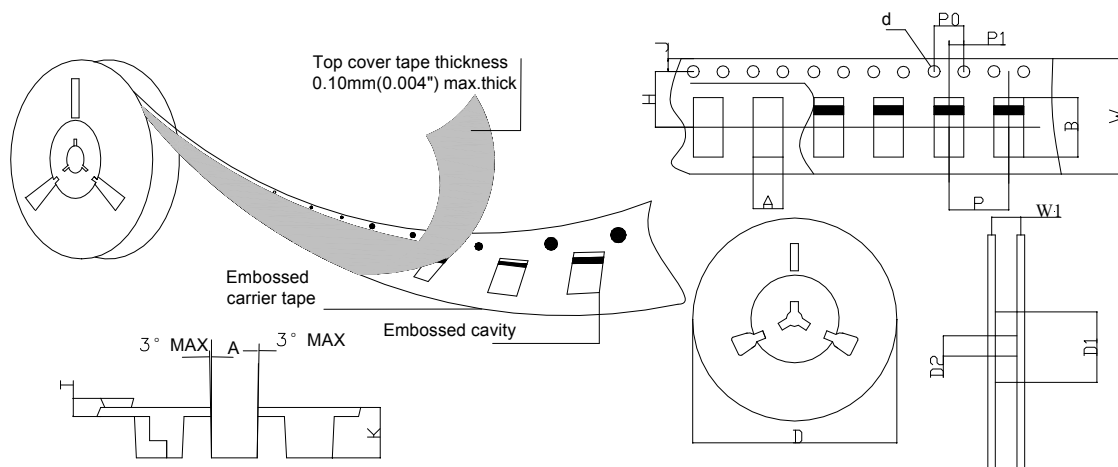

SPECIFICATIONS mm(inch)		PACKAGE
SYMBOL		SOD-123FL
ITEM		
Carrier width	A	2.1(0.083)Max
Carrier length	B	4.0(0.157)Max
Sprocket hole	d	ø1.55(0.061)Typ
Reel outer diameter	D	177.8(7)Typ
Reel inner diameter	D1	50.0(1.969)Min
Feed hole diameter	D2	13.0(0.512)Typ
Sprocket hole position	J	1.75(0.069)Typ
Punch hole position	H	3.50(0.138)Typ
Carrier depth	K	1.60(0.063)Typ
Punch hole pitch	P	4.00(0.157)Typ
Sprocket hole pitch	P0	4.00(0.157)Typ
Embossment center	P1	2.00(0.079)Typ
Overall tape thickness	T	0.25(0.098)Typ
Tape width	W	8.15(0.321)Typ
Reel width	W1	10.5(0.413)Min