

R1MF

1.0AMP. GLASS PASSIVATED FAST RECOVERY SURFACE MOUNT RECTIFIERS

FEATURE

- . Fast switching
- . High current capability
- . Low forward voltage drop
- . Low power loss, high efficiency
- . High temperature soldering guaranteed:
260°C/10 seconds at terminals.
- . For surface mounted application
- . Easy pick and place

MECHANICAL DATA

- . Case: Molded plastic
- . Epoxy: UL94V-0 rate flame retardant
- . Lead: MIL-STD- 202E, Method 208 guaranteed
- . Polarity:Color band denotes cathode end
- . Packaging:12mm tape per EIA STD RS-481
- . Mounting position: Any

SMF

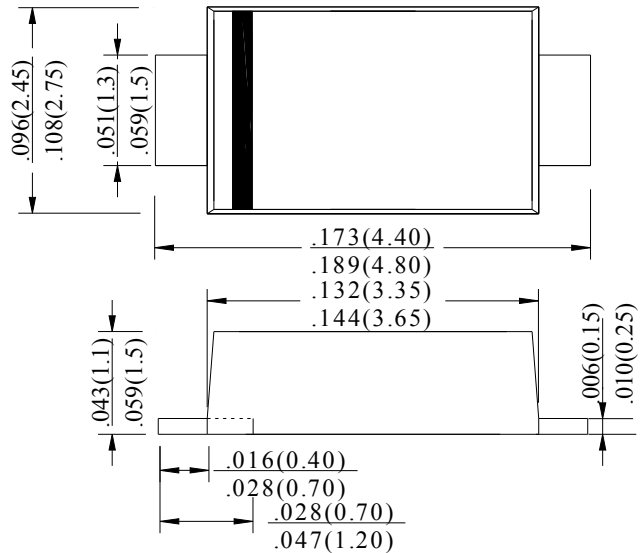

MAXIMUM RATINGS AND ELECTRICAL CHARACTERISTICS

Ratings at 25°C ambient temperature unless otherwise specified.

Single phase, half wave, 60Hz, resistive or inductive load.

For capacitive load, derate current by 20%

Type Number	SYMBOL	R1MF	units
Maximum Recurrent Peak Reverse Voltage	V_{RRM}	1000	V
Maximum RMS Voltage	V_{RMS}	700	V
Maximum DC blocking Voltage	V_{DC}	1000	V
Maximum Average Forward Rectified Current at $T_C=90^\circ\text{C}$	$I_{F(AV)}$	1.0	A
Peak Forward Surge Current 8.3ms single half sine-wave superimposed on rated load (JEDEC method)	I_{FSM}	30.0	A
Maximum Forward Voltage at 1.0A DC	V_F	1.3	V
Maximum DC Reverse Current @ $T_A=25^\circ\text{C}$ at rated DC blocking voltage @ $T_A=125^\circ\text{C}$	I_R	5.0 50.0	μA
Maximum Reverse Recovery Time (Note 1)	t_{rr}	500	nS
Typical Junction Capacitance (Note2)	C_j	12	pF
Typical Thermal Resistance (Note 3)	$R_{(JA)}$	80	$^\circ\text{C} / \text{W}$
	$R_{(JC)}$	28	
Storage Temperature	T_{STG}	-55 to +150	$^\circ\text{C}$
Operation Junction Temperature	T_J	-55 to +150	$^\circ\text{C}$

Note:

1. Test Conditions: $I_F=0.5\text{A}$, $I_R=1.0\text{A}$, $I_{RR}=0.25\text{A}$
2. Measured at 1MHz and applied reverse voltage of 4.0 volts d.c.
3. T Measured on P.C.Board with $0.6 \times 0.6''$ (15.0×15.0cm) Copper Pad Areas.

RATING AND CHARACTERISTIC CURVES (R1MF)

FIG.1-TYPICAL FORWARD CURRENT DERATING CURVE

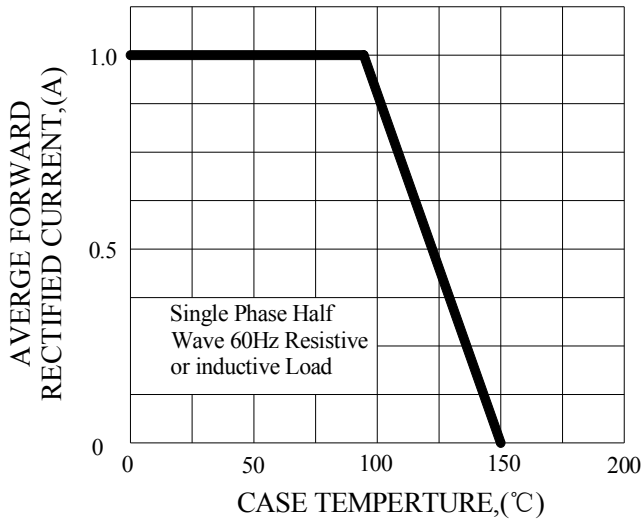

FIG.2-TYPICAL INSTANTANEOUS FORWARD CHARACTERISTICS

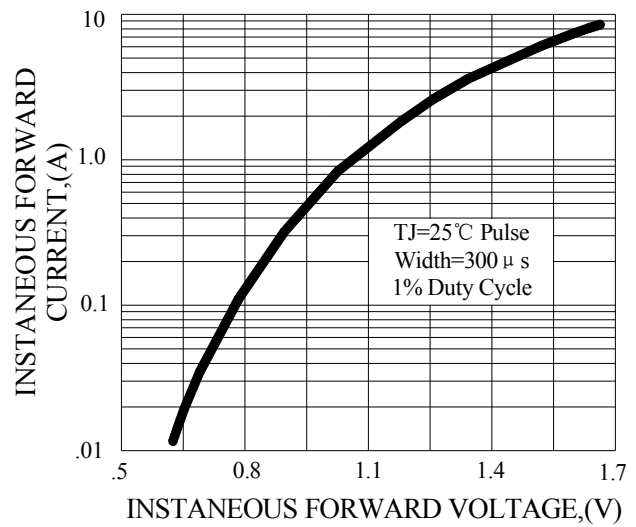

FIG.3-MAXIMUM NON-REPETITIVE FORWARD SURGE CURRENT

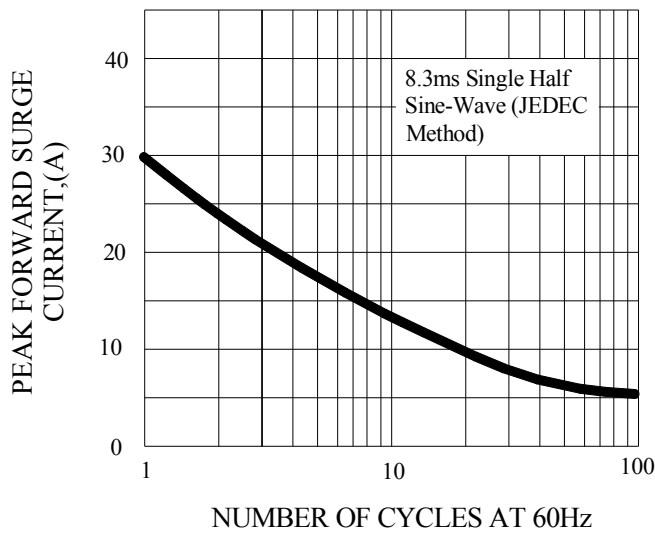

FIG.4-TYPICAL REVERSE CHARACTERISTICS

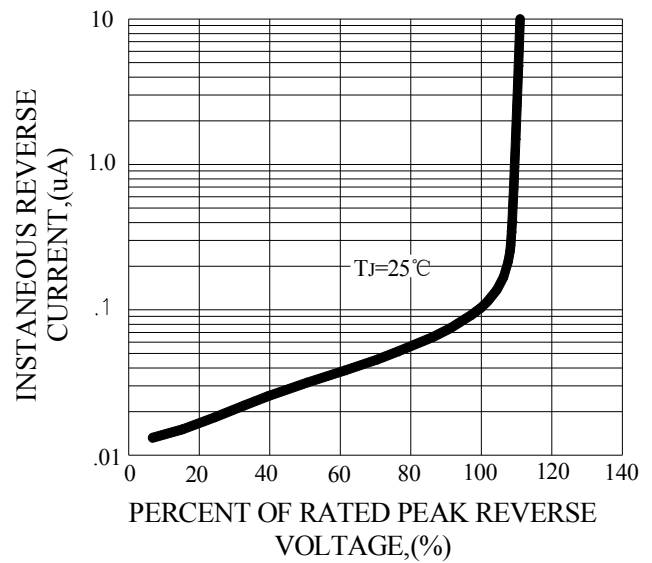
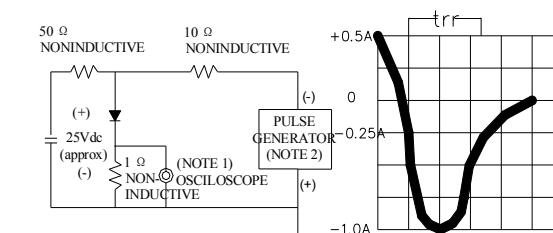

FIG.5-TEST CIRCUIT DIAGRAM AND REVERSE RECOVERY TIME CHARACTERISTIC



NOTES: 1. Rise Time=7ns max, Input Impedance= 1 megohm.22pF.
2. Rise Time=10ns max, Source Impedance= 50 ohms.

Marking 、 Structure and packaging illustration

1、 Marking

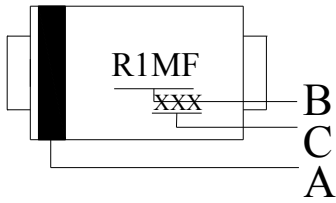

SYMBOL	Explanation
A	Color Band Denotes Cathode
B	Product Name
C	Date Code

2、 Structure

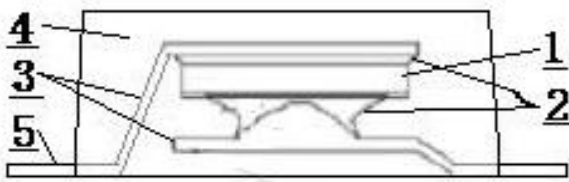

SYMBOL	Explanation
1	Dice
2	Solder
3	Lead Wire
4	Epoxy Compound
5	Plating

3、 Packaging

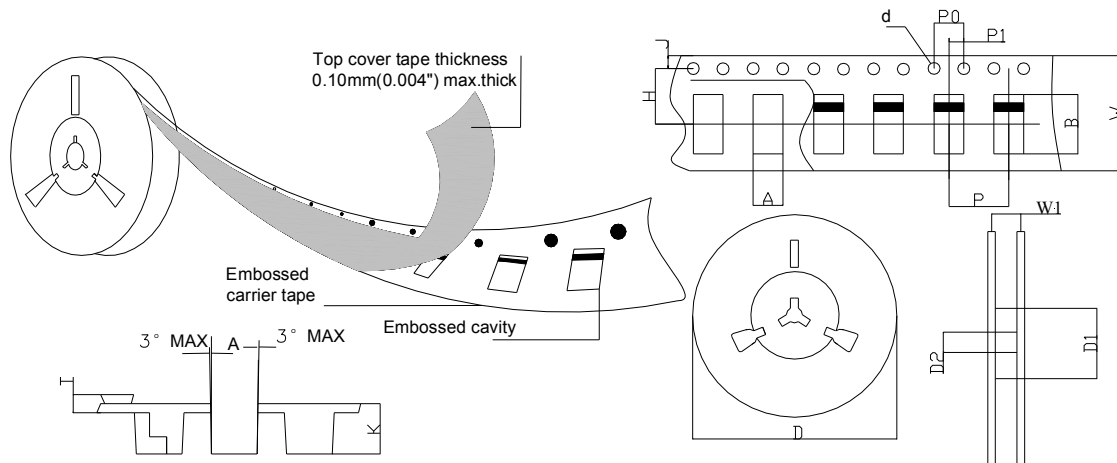

SPECIFICATIONS mm(inch)		PACKAGE			
SYMBOL		SMF			
ITEM					
Carrier width	A	2.93(0.115)Max	Punch hole position	H	5.50(0.217)Typ
Carrier length	B	4.85(0.191)Max	Carrier depth	K	1.42(0.056)Typ
Sprocket hole	d	ø1.55(0.061)Typ	Punch hole pitch	P	4.00(0.157)Typ
Reel outer diameter	D	330.0(13.0)Typ	Sprocket hole pitch	P0	4.00(0.157)Typ
Reel inner diameter	D1	50.0(1.969)Min	Embossment center	P1	2.00(0.079)Typ
Feed hole diameter	D2	13.0(0.512)Typ	Overall tape thickness	T	0.25(0.010)Typ
Sprocket hole position	J	1.75(0.069)Typ	Tape width	W	12.0(0.472)Typ
			Reel width	W1	12.4(0.488)Min