

MBR3045YCT

30.0AMPS. SCHOTTKY BARRIER RECTIFIERS

FEATURE

- .High current capability
- .Low forward voltage drop
- .Low power loss, high efficiency
- .High surge capability
- .High temperature soldering guaranteed
260°C /10seconds, 0.25"(6.35mm)from case.

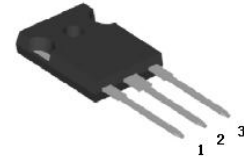

TO-247
MBR3045YCT

MECHANICAL DATA

- .Case: Molded with UL-94 Class V-0 recognized
Flame Retardant Epoxy
- .Mounting position: any

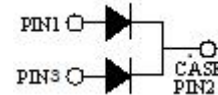

MAXIMUM RATINGS (T_C=25°C unless otherwise noted)

Parameter	Symbol	MBR3045YCT	Units
Maximum Recurrent Peak Reverse Voltage	V_{RRM}	45	V
Maximum RMS Voltage	V_{RMS}	32	V
Maximum DC blocking Voltage	V_{DC}	45	V
Maximum Average Forward Rectified Current <i>Per Leg</i> at T _C =100°C <i>Total device</i>	$I_{F(AV)}$	15.0 30.0	A
Peak Forward Surge Current 8.3ms single half sine-wave superimposed on rated load (JEDEC method) <i>Per Leg</i>	I_{FSM}	250.0	A
Typical Junction Capacitance (Note 1)	C_J	700	pF
Operation Junction Temperature and Storage Temperature	T_J, T_{STG}	-55 to +150	°C
Maximum Mounting torque, M3 or 6-32 screw		1.1N•m (10 lbf•in)	

ELECTRICAL CHARACTERISTICS-(per leg) (T_A=25°C unless otherwise noted)

Parameter	Symbol	Test conditions	Typ	Max	Units	
Forward voltage drop	V_F	T _J =25°C	I _F =3A	0.38	---	V
			I _F =5A	0.42	---	
			I _F =15A	0.55	0.65	
		T _J =125°C	I _F =3A	0.28	---	
			I _F =5A	0.33	---	
			I _F =15A	0.52	0.60	
Reverse leakage current	I_R	T _J =25°C	V _R =45V	---	250	μA
		T _J =125°C	V _R =45V	---	30	mA

THERMAL CHARACTERISTICS(T_C=25°C unless otherwise noted)

Parameter	Symbol	MBR3045YCT	Units
Typical Thermal Resistance (Note 2)	$R_{(JC)}$	0.5	°C/W

Notes:

1. Measured at 1.0 MHz and applied reverse voltage of 4.0Vdc
2. Thermal Resistance from Junction to Case

RATING AND CHARACTERISTIC CURVES

FIG.1-TYPICAL FORWARD CURRENT DERATING CURVE

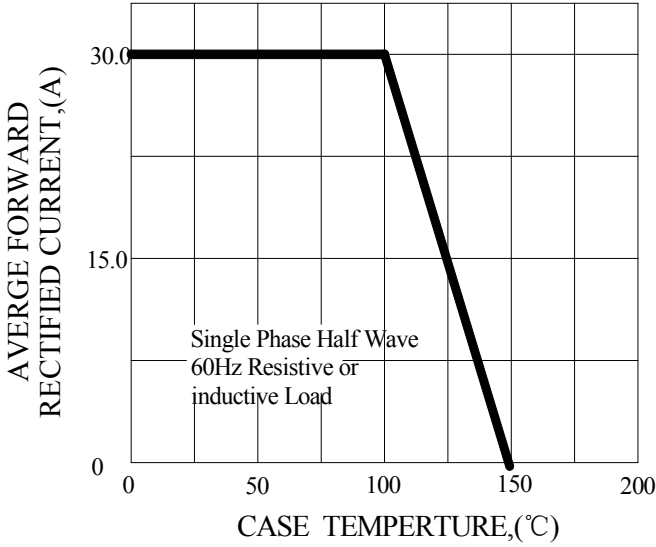

FIG.2-TYPICAL INSTANTANEOUS FORWARD CHARACTERISTICS

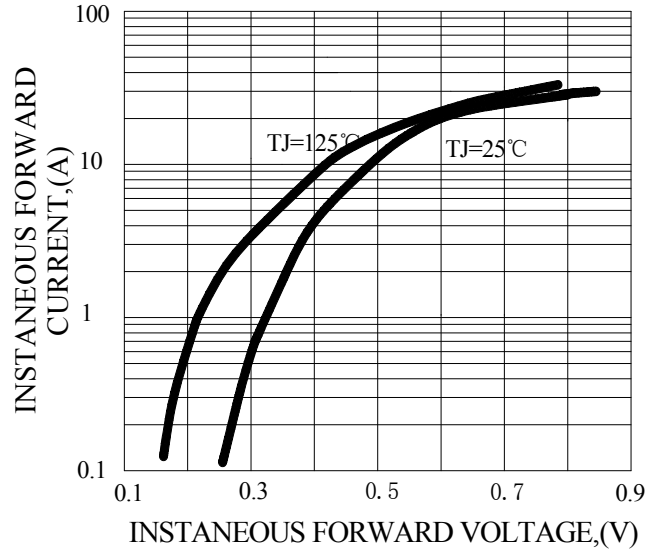

FIG.3-MAXIMUM NON-REPETITIVE FORWARD SURGE CURRENT

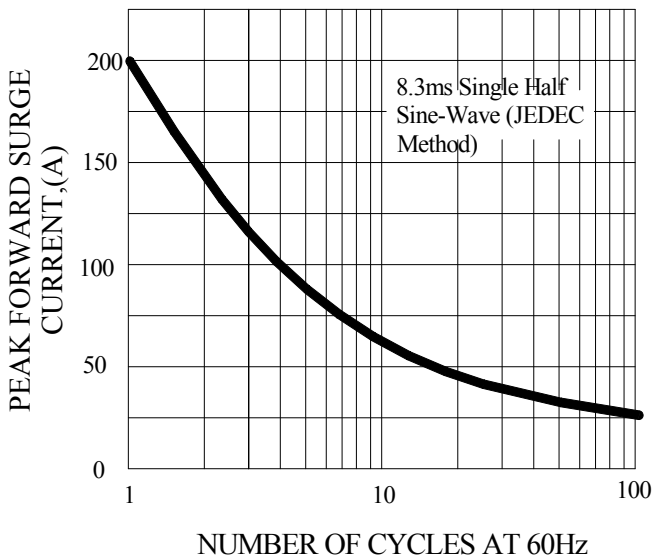
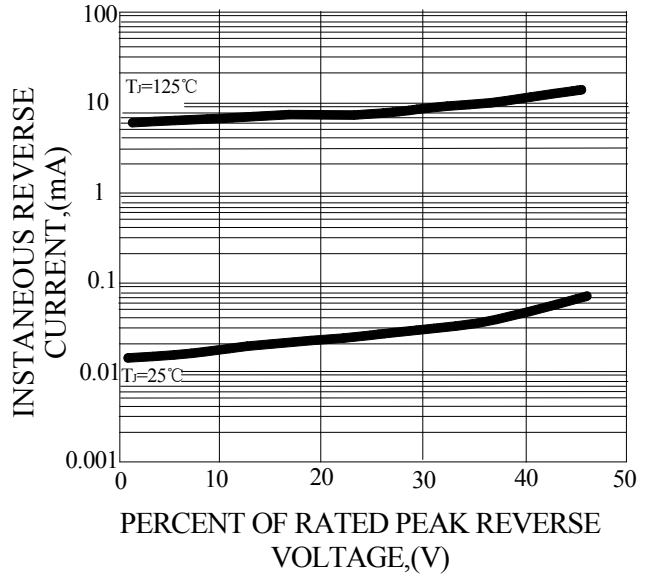
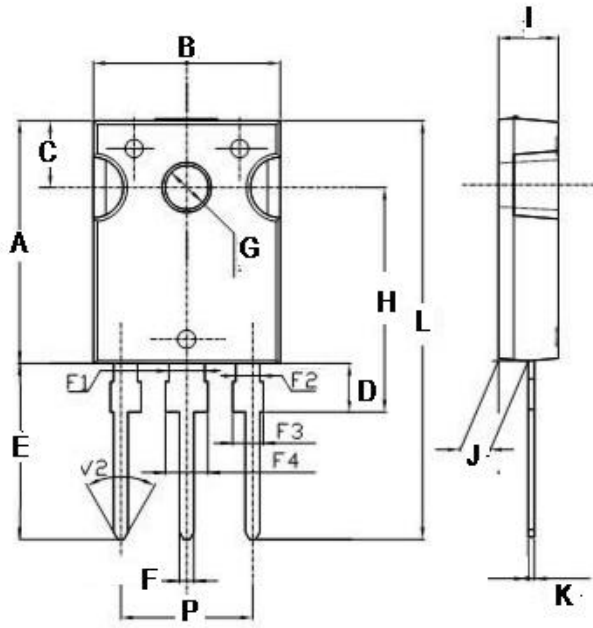

FIG.4-TYPICAL REVERSE CHARACTERISTICS



PACKAGE OUTLINE DIMENSIONS

TO-247



Dim	Min	Max
A	20.0	22.0
B	15.5	16.0
C	5.7	6.3
D	4.0	4.4
E	19.0	21.0
F	1.1	1.3
G	3.5	3.8
H	18.3	20.2
I	4.9	5.2
J	2.3	2.5
K	0.55	0.65
L	39.0	42.0
P	5.35	5.45
F1	2.8	3.1
F2	1.9	2.1
F3	2.0	2.2
F4	3.0	3.3
mm		

Dimensions in inches and (millimeters)