

M4N65TF

4 Amps,650 Volts N-CHANNEL MOSFET

FEATURE

- 4A,650V, $R_{DS(ON)MAX}=2.3\ \Omega @V_{GS}=10V/2A$
- Low gate charge
- Low C_{iss}
- Fast switching
- 100% avalanche tested
- Improved dv/dt capability

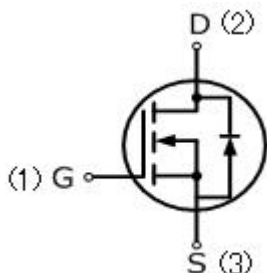

TO-220TF

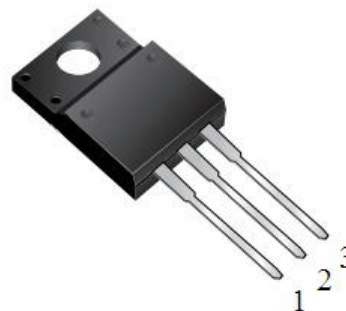

Absolute Maximum Ratings ($T_C=25^\circ\text{C}$, unless otherwise noted)

Parameter	Symbol	M4N65TF	UNIT
Drain-Source Voltage	V_{DSS}	650	V
Gate-Source Voltage	V_{GSS}	± 30	
Continuous Drain Current	I_D	4	A
Pulsed Drain Current(Note 1)	I_{DM}	16	
Single Pulse Avalanche Energy (Note 2)	E_{AS}	150	mJ
Reverse Diode dV/dt (Note 3)	dv/dt	2.63	V/ns
Operating Junction and Storage Temperature Range	T_J, T_{STG}	-55 to +150	$^\circ\text{C}$
Maximum lead temperature for soldering purposes, 1/8" from case for 5 seconds	T_L	260	$^\circ\text{C}$
Mounting Torque	6-32 or M3 screw	10	lbf • in
		1.1	N • m

Thermal Characteristics

Parameter	Symbol	M4N65TF	Units
Maximum Junction-to-Case	R_{thJC}	3.47	$^\circ\text{C}/\text{W}$
Maximum Power Dissipation	P_D	34	W

Electrical Characteristics ($T_c=25^\circ\text{C}$, unless otherwise noted)						
Parameter	Symbol	Test Conditions	Min	Typ	Max	Units
Off Characteristics						
Drain-Source Breakdown Voltage	BV_{DSS}	$V_{GS}=0V, I_D=250\mu A$	650	—	—	V
Breakdown Temperature Coefficient	$\Delta BV_{DSS} / \Delta T_J$	Reference to 25°C , $I_D=250\mu A$	—	0.67	—	$V/^\circ\text{C}$
Zero Gate Voltage Drain Current	I_{DSS}	$V_{DS}=650V, V_{GS}=0V$	—	—	1	μA
Gate-Body Leakage Current, Forward	I_{GSSF}	$V_{GS}=30V, V_{DS}=0V$	—	—	100	nA
Gate-Body Leakage Current, Reverse	I_{GSSR}	$V_{GS}=-30V, V_{DS}=0V$	—	—	-100	nA
On Characteristics						
Gate-Source Threshold Voltage	$V_{GS(th)}$	$V_{DS}=V_{GS}, I_D=250\mu A$	2	—	4	V
Drain-Source On-State Resistance	$R_{DS(on)}$	$V_{GS}=10V, I_D=2A$	—	2.0	2.3	Ω
Pulse width $t_p \leq 380\mu s$, $\delta \leq 2\%$						
Dynamic Characteristics						
Input Capacitance	C_{iss}	$V_{DS}=25V, V_{GS}=0V$, $f=1.0\text{MHz}$	—	434	—	pF
Output Capacitance	C_{oss}		—	60	—	pF
Reverse Transfer Capacitance	C_{rss}		—	6	—	pF
Switching Characteristics						
Turn-On Delay Time	$t_{d(on)}$	$V_{DD}=30V, I_D=0.5A$, $R_G=25\Omega, V_{GS}=10V$ (Note3,4)	—	44	—	ns
Turn-On Rise Time	t_r		—	50	—	ns
Turn-Off Delay Time	$t_{d(off)}$		—	80	—	ns
Turn-Off Fall Time	t_f		—	45	—	ns
Total Gate Charge	Q_g	$V_{DS}=50V, I_D=1.3A$, $V_{GS}=10V$ (Note3,4)	—	17	—	nC
Gate-Source Charge	Q_{gs}		—	4.9	—	nC
Gate-Drain Charge	Q_{gd}		—	3.7	—	nC
Drain-Source Body Diode Characteristics and Maximum Ratings						
Diode Forward Voltage	V_{SD}	$I_S=4A, V_{GS}=0V$	—	—	1.5	V
Reverse Recovery Time	t_{rr}	$V_{GS}=0V, I_S=4A, T_j=25^\circ\text{C}$	—	415	—	ns
Reverse Recovery Charge	Q_{rr}		$dI_F/dt=100A/\mu s$ (Note3)	—	2.1	—

Notes

1. Repetitive Rating: pulse width limited by maximum junction temperature .
2. $V_{DD}=50V$, starting, $L=20\text{mH}, R_g=25\Omega, I_{AS}=3.7A, T_j=25^\circ\text{C}$.
3. $dI/dt= _A/\mu s$, starting $T_j=25^\circ\text{C}$, Pulse width $\leq 300\mu s$; duty cycle $\leq 2\%$.
4. Repetitive rating; pulse width limited by maximum junction temperature.

TEST CIRCUIT AND WAVEFORM

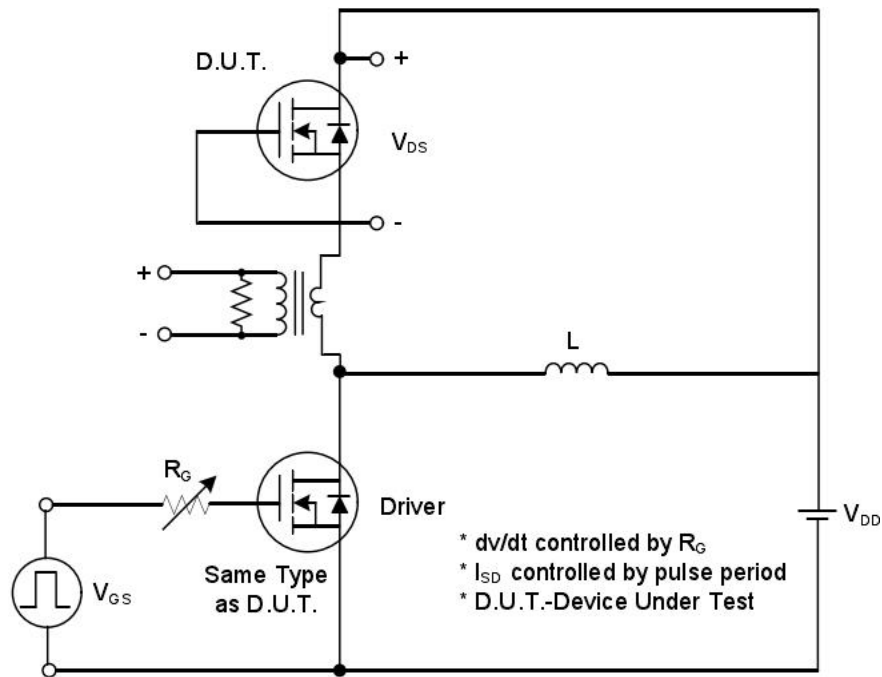

Peak Diode Recovery dv/dt Test Circuit

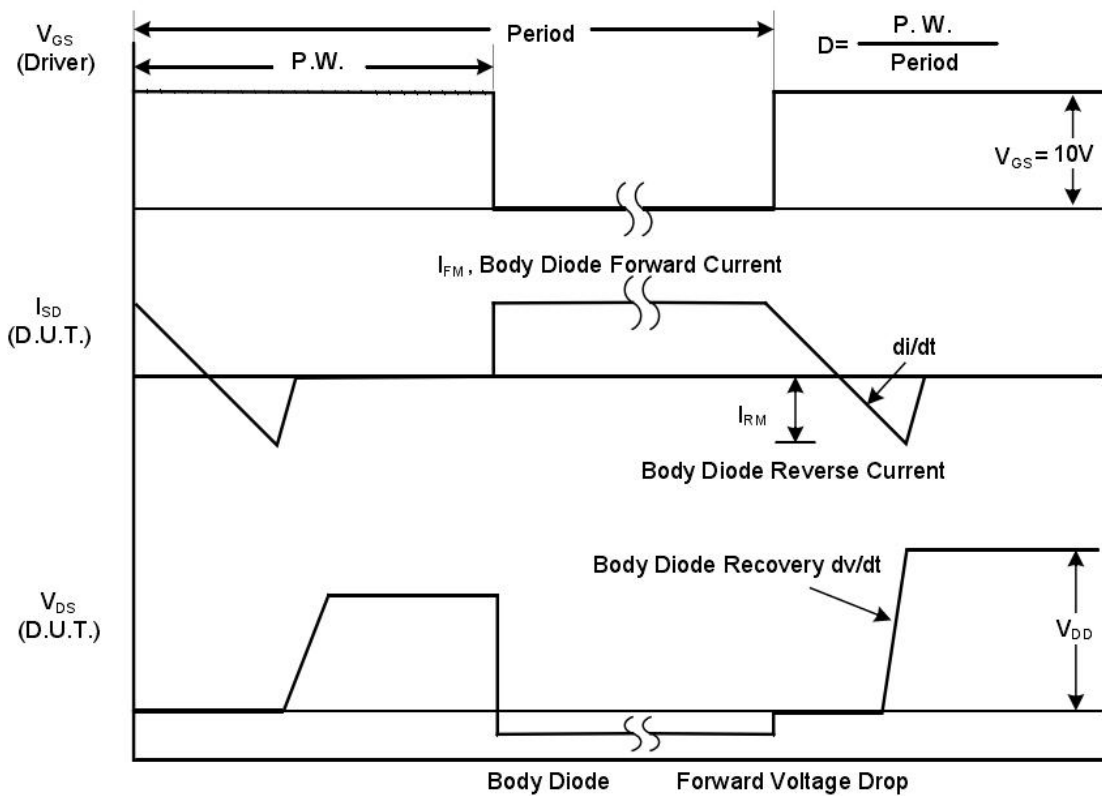

Peak Diode Recovery dv/dt Waveforms

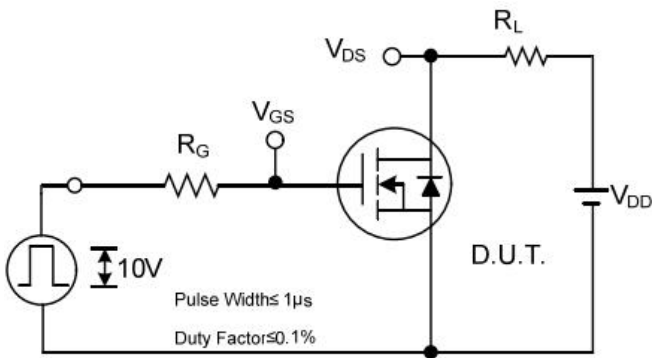

Switching Test Circuit

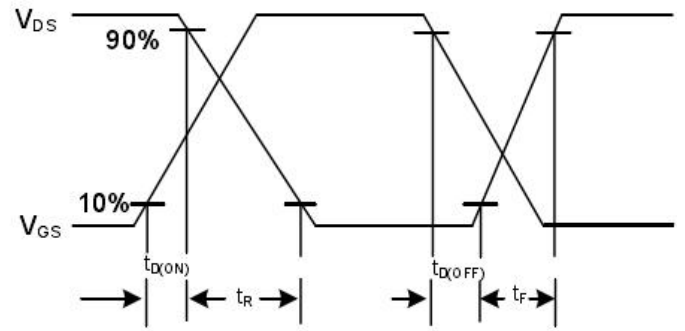

Switching Waveforms

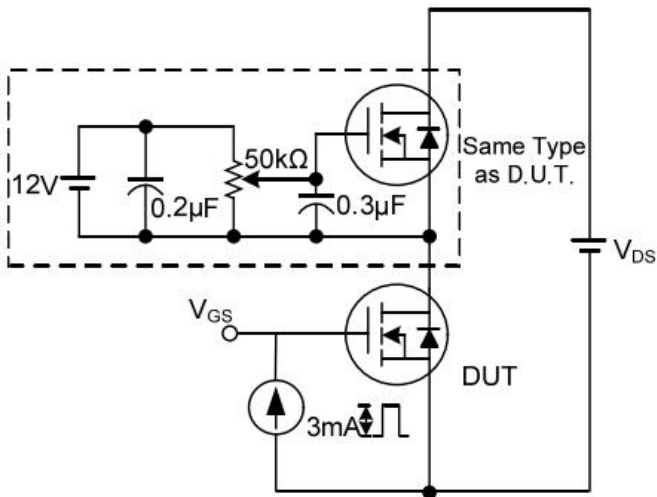

Gate Charge Test Circuit

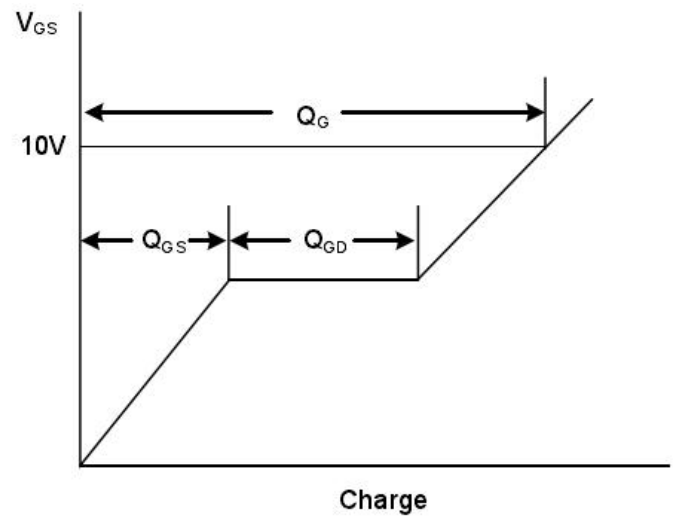

Gate Charge Waveform

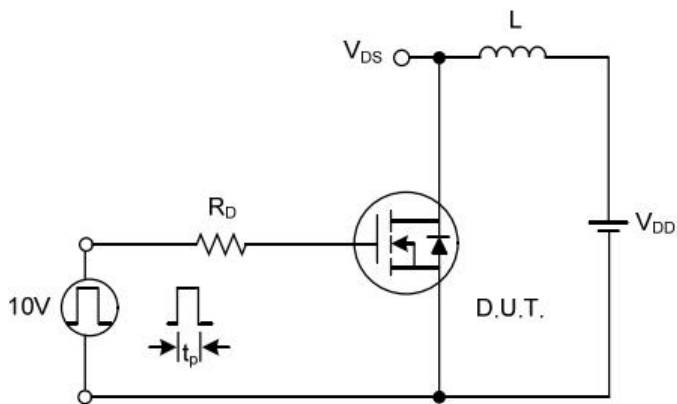

Unclamped Inductive Switching Test Circuit

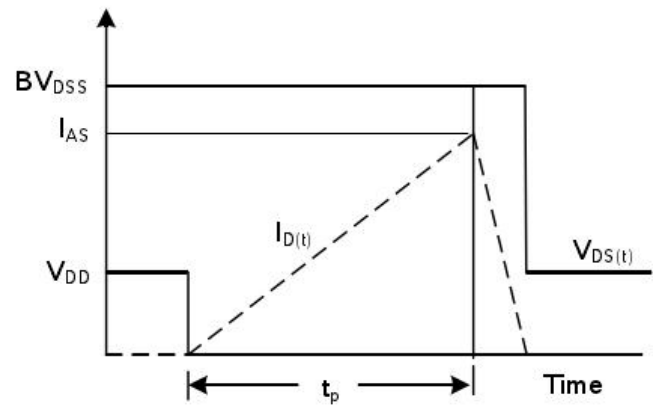

Unclamped Inductive Switching Waveforms

RATING AND CHARACTERISTIC CURVES

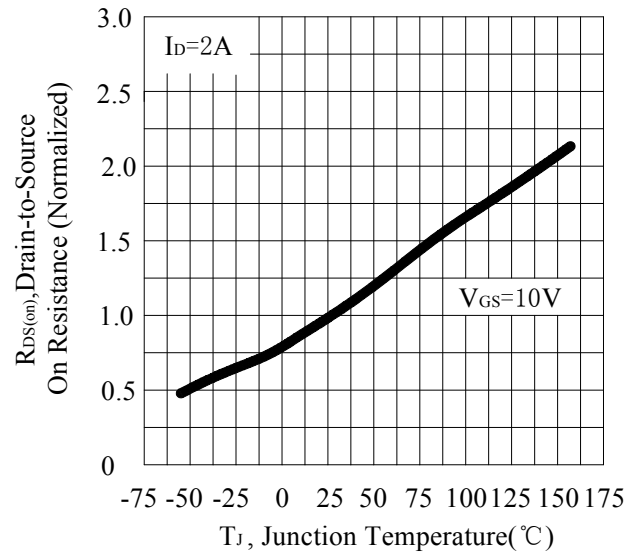
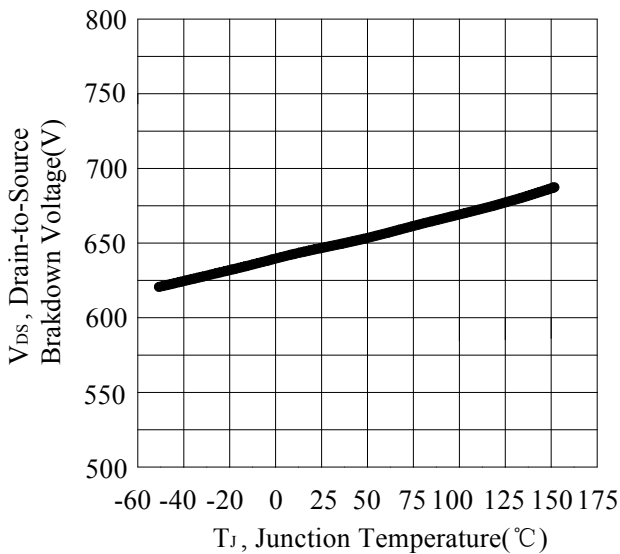
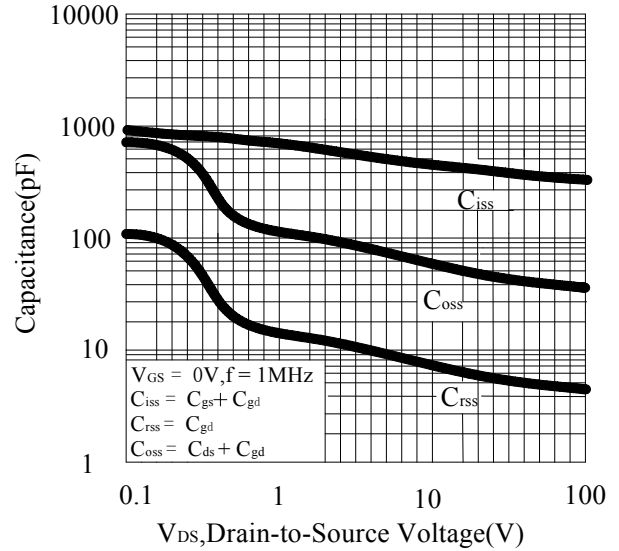
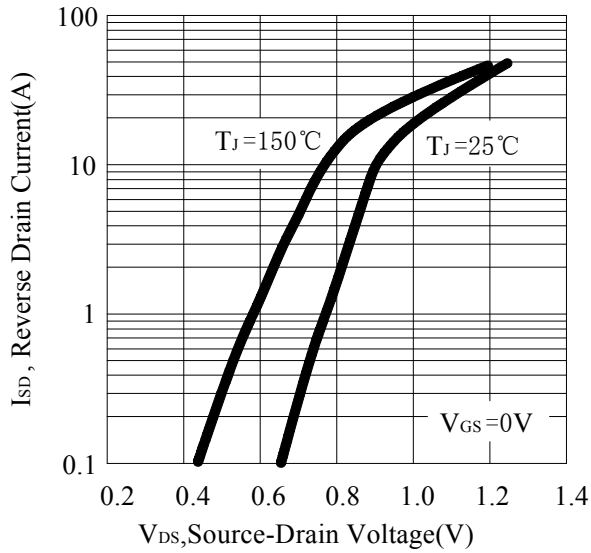
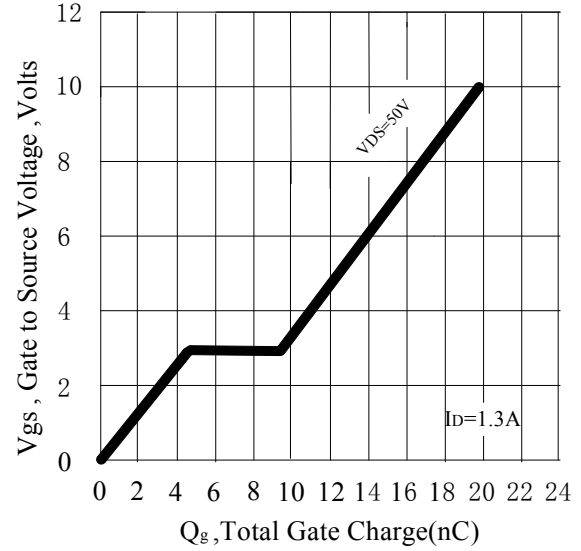
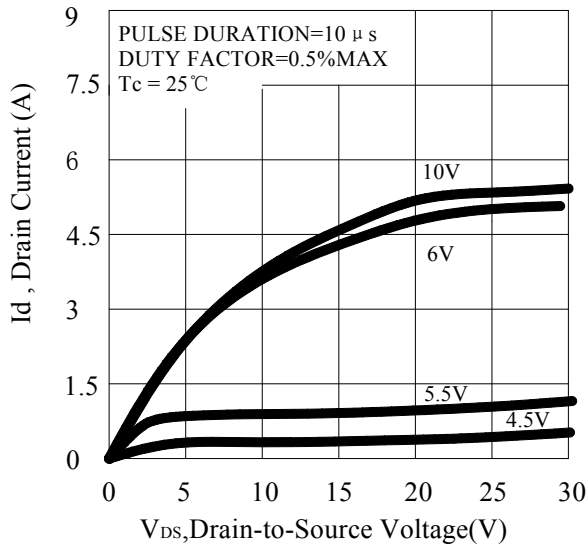

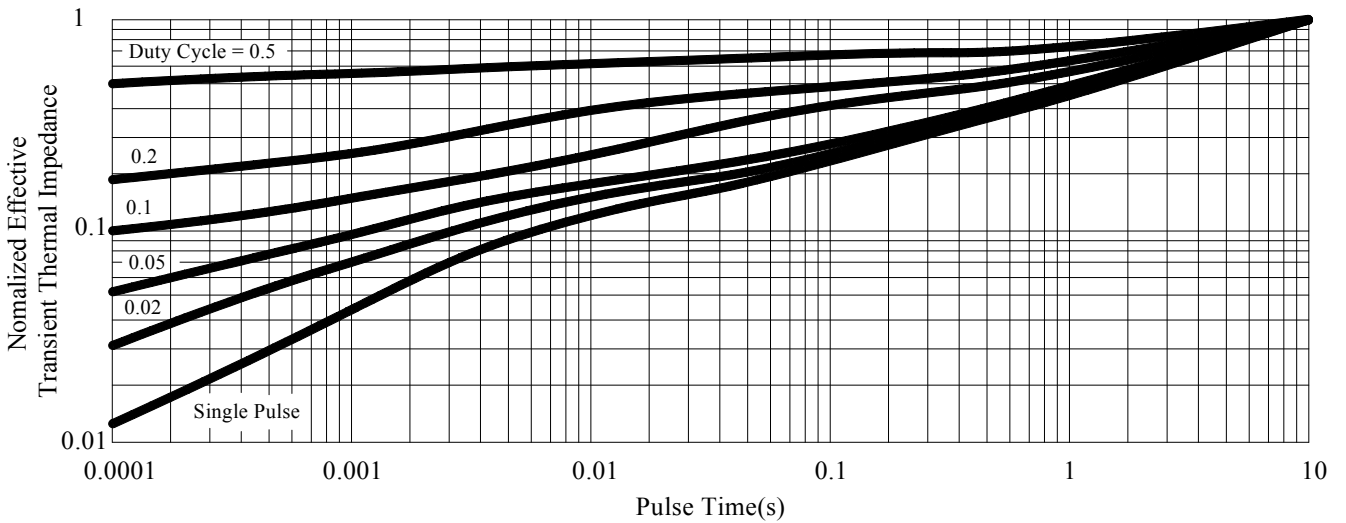
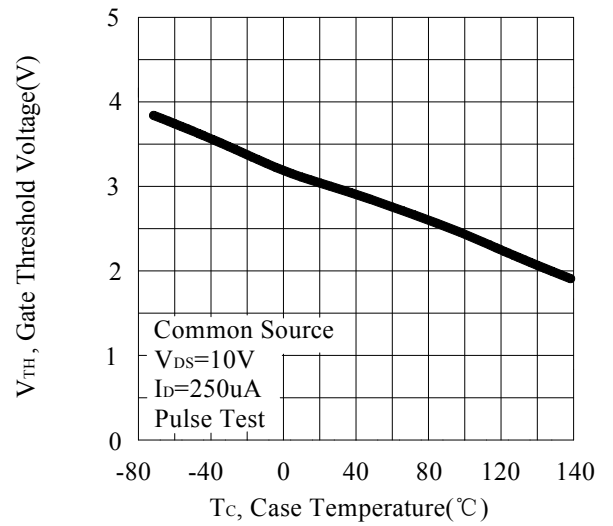
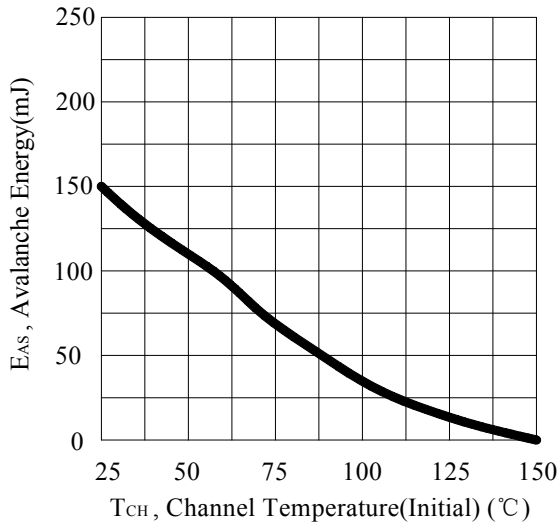
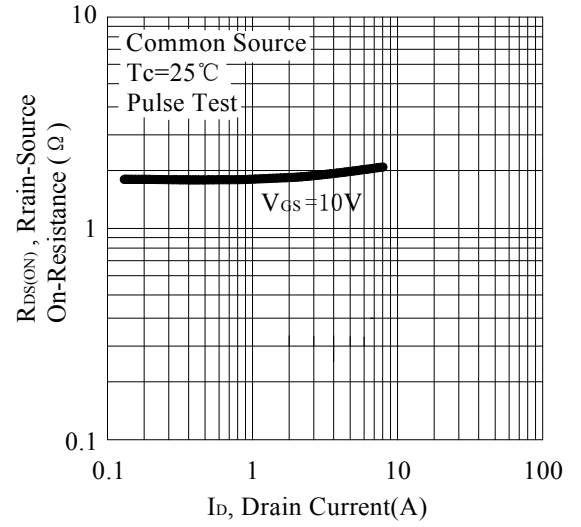
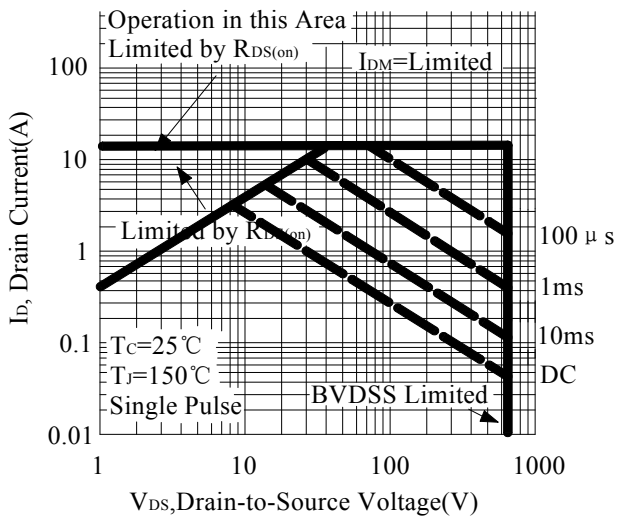

PACKAGE OUTLINE DIMENSIONS

TO-220TF

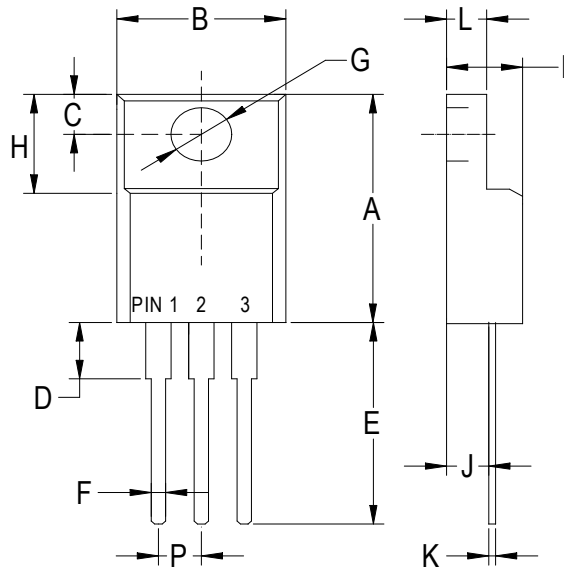

TO-220TF		
Dim	Min	Max
A	.590 (15.0)	.650 (16.5)
B	.393 (10.0)	.414 (10.5)
C	.118 (3.00)	.138 (3.50)
D	.118 (3.00)	.146 (3.70)
E	.512 (13.0)	.551 (14.0)
F	.028 (0.70)	.035 (0.90)
G	.114 (2.90)	.138 (3.50)
H	.255 (6.50)	.280 (7.10)
I	.173 (4.40)	.197 (5.00)
J	.102 (2.60)	.110 (2.80)
K	.018 (0.45)	.026 (0.65)
L	.092 (2.35)	.109 (2.75)
P	.890 (2.25)	.113 (2.85)