

## Cautions and Warnings

Please be noted that this spec is only for reference if you have projects designed with the product number listed in. If you are looking for new project design-in, please find BMRx Series specification/datasheet on Chilisin website. Or you may find our sales contact for more information on old part number at your convenience. Appreciated your attention and understanding.

**Note:** Please be sure to request approval specifications that provide further details of the products. Kindly note that the content of these specifications are subject to change or may be discontinued without prior notice. This product may not be designed/used in medical or high risk applications without Chilisin approval. Please contact our sales department before ordering.

## MHCC、MHCI Series



MHCC series is designed for low profile type with low RDC and ultra large current. Its molded magnetic shielded type is suitable for high-density mounting and ultra low buzz noise. Soldering conditions can be easily confirmed when mounting onto the board. This series also provides customers with embossed carrier type packaging for automatic mounting machine.

### Features

- RoHS, Halogen Free and REACH Compliance
- High rated current
- Ultra low buzz noise

### Applications

- Laptops and PCs
- Switches and servers
- Base stations
- DC/DC converters

### Product Identification

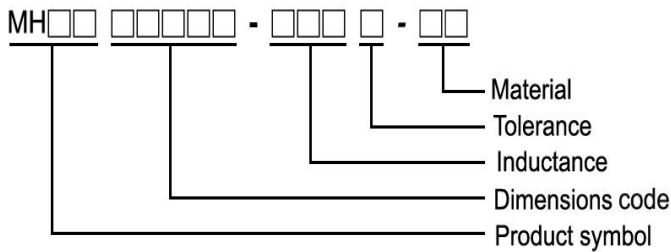

### Shape and Dimensions

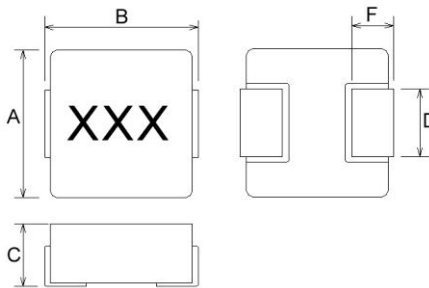

### Recommended Pattern

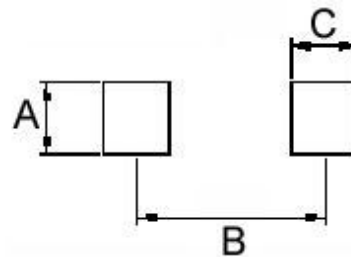

Dimensions in mm

| TYPE  | A        | B Max   | C Max   | D       | F       |
|-------|----------|---------|---------|---------|---------|
| 04012 | 4.1±0.2  | 4.6±0.2 | 1.2     | 1.5±0.3 | 1.0±0.5 |
| 04015 | 4.1±0.2  | 4.6±0.2 | 1.5     | 1.5±0.3 | 1.0±0.5 |
| 04020 | 4.1±0.2  | 4.6±0.2 | 2.0     | 1.5±0.3 | 1.0±0.5 |
| 05012 | 5.4±0.35 | 5.7±0.2 | 1.2     | 2.0±0.3 | 1.5±0.3 |
| 05015 | 5.4±0.35 | 5.7±0.2 | 1.5     | 2.0±0.3 | 1.5±0.3 |
| 05018 | 5.4±0.35 | 5.7±0.2 | 1.8     | 2.0±0.3 | 1.5±0.3 |
| 05020 | 5.4±0.35 | 5.7±0.2 | 1.8±0.2 | 2.0±0.3 | 1.5±0.3 |
| 05030 | 5.4±0.35 | 5.7±0.2 | 3.0     | 2.0±0.3 | 1.5±0.3 |
| 06012 | 6.6±0.2  | 7.3     | 1.2     | 2.9     | 1.6±0.5 |
| 06015 | 6.6±0.2  | 7.3     | 1.3±0.2 | 2.9     | 1.6±0.5 |
| 06018 | 6.6±0.2  | 7.3     | 1.6±0.2 | 2.9     | 1.6±0.5 |
| 06024 | 6.6±0.2  | 7.3     | 2.4     | 2.9     | 1.6±0.5 |
| 06030 | 6.6±0.2  | 7.3     | 3.0     | 2.9     | 1.6±0.5 |
| 06050 | 6.6±0.2  | 7.3     | 5.0     | 2.9     | 1.6±0.5 |
| 10030 | 10.1±0.3 | 11.6    | 3.0     | 3.0     | 2.5±0.5 |
| 10040 | 10.1±0.3 | 11.6    | 4.0     | 3.0     | 2.5±0.5 |
| 12050 | 12.6±0.2 | 13.8    | 5.0     | 3.7     | 2.7±0.7 |
| 12060 | 12.6±0.2 | 13.8    | 6.0     | 3.7     | 2.7±0.7 |

Dimensions in mm

| TYPE  | A   | B    | C    |
|-------|-----|------|------|
| 04012 | 2.5 | 3.7  | 1.5  |
| 04015 | 2.5 | 3.7  | 1.5  |
| 04020 | 2.5 | 3.7  | 1.5  |
| 05012 | 2.5 | 4.1  | 1.9  |
| 05015 | 2.5 | 4.1  | 1.9  |
| 05018 | 2.5 | 4.1  | 1.9  |
| 05020 | 2.5 | 4.1  | 1.9  |
| 05030 | 2.5 | 4.1  | 1.9  |
| 06012 | 3.5 | 6.05 | 2.35 |
| 06015 | 3.5 | 6.05 | 2.35 |
| 06018 | 3.5 | 6.05 | 2.35 |
| 06024 | 3.5 | 6.05 | 2.35 |
| 06030 | 3.5 | 6.05 | 2.35 |
| 06050 | 3.5 | 6.05 | 2.35 |
| 10030 | 4.0 | 9.5  | 3.5  |
| 10040 | 4.0 | 9.5  | 3.5  |
| 12050 | 5.0 | 10.5 | 4.0  |
| 12060 | 5.5 | 10.5 | 4.0  |

# Molding Power Inductors – MHCC/MHCI Series

## Electrical Characteristics

| Part Number       | Inductance (uH) | Tolerance (±%) | Test Frequency (kHz) | RDC (mΩ) Max | Isat (A)Typ. | Irms (A)Typ. |
|-------------------|-----------------|----------------|----------------------|--------------|--------------|--------------|
| MHCI04012-R22M-R8 | 0.22            | 20             | 100                  | 12           | 11.5         | 8.5          |
| MHCI04012-R33M-R8 | 0.33            | 20             | 100                  | 19           | 8.5          | 6.5          |
| MHCI04012-R47M-R8 | 0.47            | 20             | 100                  | 25           | 7.0          | 5.0          |
| MHCI04012-R68M-R8 | 0.68            | 20             | 100                  | 36           | 6.0          | 4.5          |
| MHCI04012-1R0M-R8 | 1.0             | 20             | 100                  | 47           | 5.2          | 4.2          |
| MHCI04012-1R5M-R8 | 1.5             | 20             | 100                  | 75           | 4.0          | 3.25         |
| MHCI04012-2R2M-R8 | 2.2             | 20             | 100                  | 83.5         | 3.5          | 2.75         |
| MHCI04012-3R3M-R8 | 3.3             | 20             | 100                  | 165          | 3.0          | 2.0          |
| MHCI04012-4R7M-R8 | 4.7             | 20             | 100                  | 195          | 2.8          | 1.8          |

**Note: When ordering, please specify tolerance code. Tolerance: M=±20%**

- Operating temperature range - 55°C ~ 125°C(Including self - temperature rise)
- Isat for Inductance drop 30% from its value without current
- I rms for a 40°C temperature rise from 25°C ambient with current
- Absolute maximum voltage 30VDC
- Measure Equipment :
  - L : WK 3260B or WK 6500P, 100kHz 0.5V
  - RDC : CHEN HWA 502 or CHEN HWA 46502B

**Test Instruments :** WK3260B Impedance / Material Analyzer

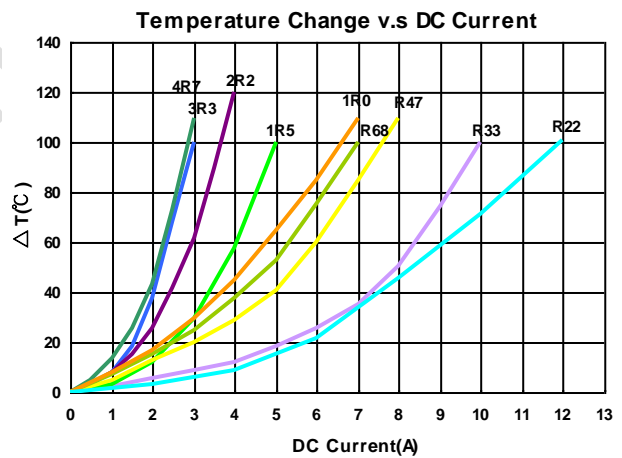
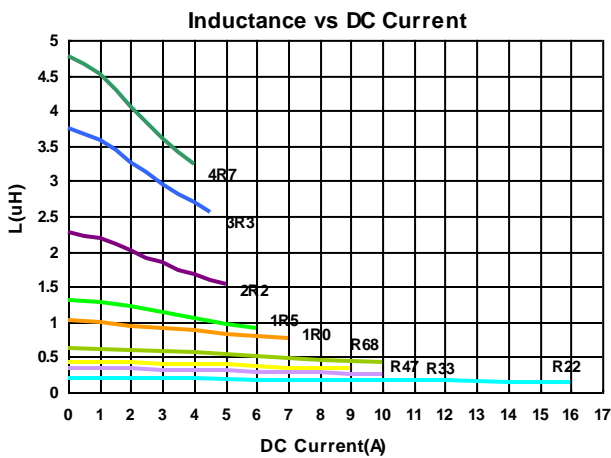

# Molding Power Inductors – MHCC/MHCI Series

## Electrical Characteristics

| Part Number       | Inductance (uH) | Tolerance (±%) | Test Frequency (kHz) | RDC (mΩ) Max | Isat (A)Typ. | Irms (A)Typ. |
|-------------------|-----------------|----------------|----------------------|--------------|--------------|--------------|
| MHCI04015-1R0M-R8 | 1.0             | 20             | 100                  | 42           | 7            | 4            |
| MHCI04015-1R5M-R8 | 1.5             | 20             | 100                  | 50           | 6            | 3.5          |
| MHCI04015-2R2M-R8 | 2.2             | 20             | 100                  | 79           | 5            | 3            |
| MHCI04015-3R3M-R8 | 3.3             | 20             | 100                  | 132          | 4.5          | 2.3          |
| MHCI04015-4R7M-R8 | 4.7             | 20             | 100                  | 146          | 4            | 2            |

**Note: When ordering, please specify tolerance code. Tolerance: M=±20%**

- Operating temperature range - 55°C ~ 125°C(Including self - temperature rise)
- Isat for Inductance drop 30% from its value without current
- I rms for a 40°C temperature rise from 25°C ambient with current
- Absolute maximum voltage 30VDC
- Measure Equipment :  
L : WK 3260B or WK 6500P, 100kHz 0.5V  
RDC : CHEN HWA 502 or CHEN HWA 46502B

**Test Instruments :** WK3260B Impedance / Material Analyzer

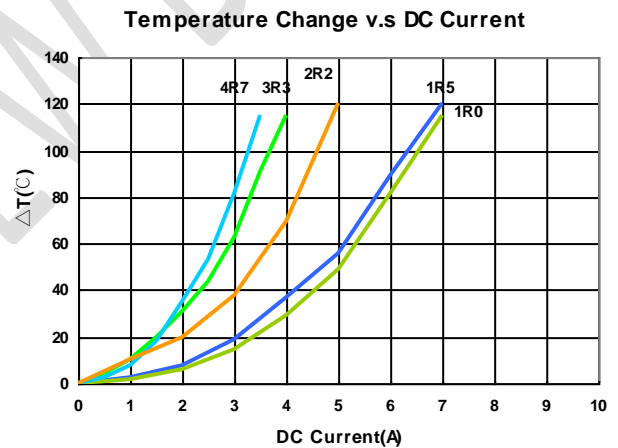
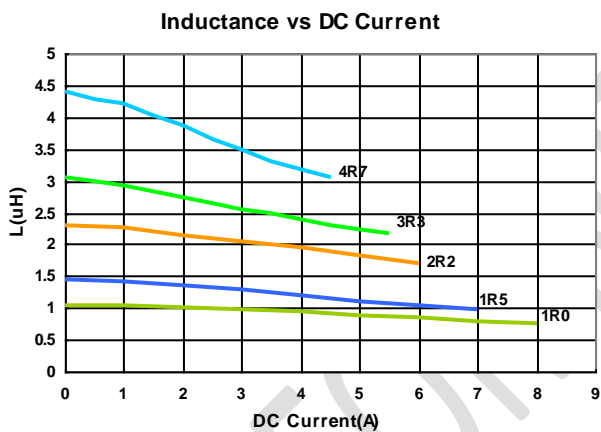

# Molding Power Inductors – MHCC/MHCI Series

## Electrical Characteristics

| Part Number       | Inductance (uH) | Tolerance (±%) | Test Frequency (kHz) | RDC (mΩ) Max | Isat (A)Typ. | Irms (A)Typ. |
|-------------------|-----------------|----------------|----------------------|--------------|--------------|--------------|
| MHCI04020-R10M-R8 | 0.10            | 20             | 100                  | 4            | 25           | 12.0         |
| MHCI04020-R22M-R8 | 0.22            | 20             | 100                  | 6.6          | 12.5         | 9.0          |
| MHCI04020-R47M-R8 | 0.47            | 20             | 100                  | 14           | 9.5          | 7.0          |
| MHCI04020-R56M-R8 | 0.56            | 20             | 100                  | 16           | 10.0         | 6.5          |
| MHCI04020-R68M-R8 | 0.68            | 20             | 100                  | 21           | 8.0          | 5.2          |
| MHCI04020-1R0M-R8 | 1.0             | 20             | 100                  | 27           | 7.0          | 4.5          |
| MHCI04020-1R5M-R8 | 1.5             | 20             | 100                  | 46           | 6.0          | 4.0          |
| MHCI04020-2R2M-R8 | 2.2             | 20             | 100                  | 58           | 5.0          | 3.0          |
| MHCI04020-3R3M-R8 | 3.3             | 20             | 100                  | 87           | 4.0          | 2.5          |
| MHCI04020-4R7M-R8 | 4.7             | 20             | 100                  | 126          | 3.0          | 2.2          |
| MHCI04020-6R8M-R8 | 6.8             | 20             | 100                  | 135          | 2.5          | 2.0          |
| MHCI04020-8R2M-R8 | 8.2             | 20             | 100                  | 216          | 2.5          | 2.0          |
| MHCI04020-100M-R8 | 10              | 20             | 100                  | 258          | 2.0          | 1.6          |

**Note: When ordering, please specify tolerance code. Tolerance: M=±20%**

- Operating temperature range - 55°C ~ 125°C(Including self - temperature rise)
- Isat for Inductance drop 30% from its value without current
- Irms for a 40°C temperature rise from 25°C ambient with current
- Absolute maximum voltage 30VDC
- Measure Equipment :  
L : WK 3260B or WK 6500P, 100KHz 0.5V  
RDC : CHEN HWA 502 or CHEN HWA 46502B

**Test Instruments : WK3260B Impedance / Material Analyzer**

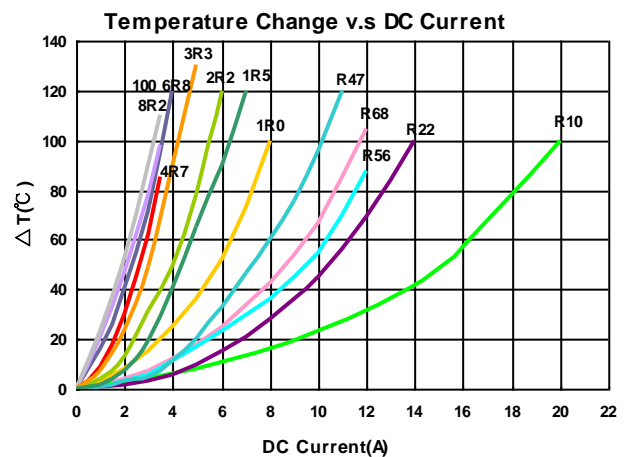
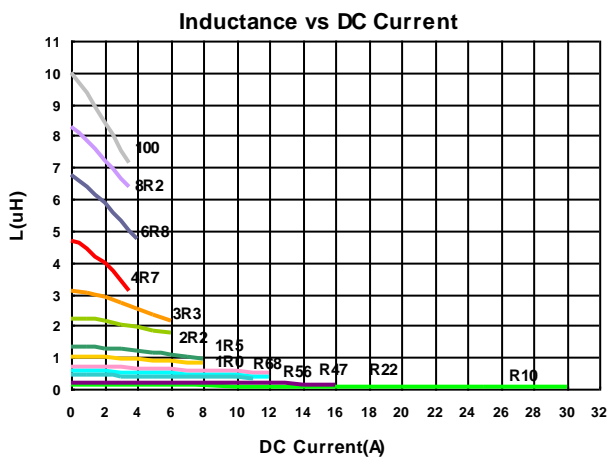

# Molding Power Inductors – MHCC/MHCI Series

## Electrical Characteristics

| Part Number        | Inductance (uH) | Tolerance (±%) | Test Frequency (kHz) | RDC (mΩ) Max | Isat (A)Typ. | Irms (A)Typ. |
|--------------------|-----------------|----------------|----------------------|--------------|--------------|--------------|
| MHCI05012-1R0M-R8A | 1.0             | 20             | 100                  | 30           | 6.0          | 5.0          |
| MHCI05012-2R2M-R8A | 2.2             | 20             | 100                  | 76           | 4.0          | 3.5          |
| MHCI05012-6R8M-R8A | 6.8             | 20             | 100                  | 250          | 2.3          | 2.0          |

**Note: When ordering, please specify tolerance code. Tolerance: M=±20%**

- Operating temperature range - 55°C ~ 125°C(Including self - temperature rise)
- Isat for Inductance drop 30% from its value without current
- I rms for a 40°C temperature rise from 25°C ambient with current
- Absolute maximum voltage 30VDC
- Measure Equipment :  
 L : WK 3260B or WK 6500P, 100kHz 0.5V  
 RDC : CHEN HWA 502 or CHEN HWA 46502B

**Test Instruments :** WK3260B Impedance / Material Analyzer

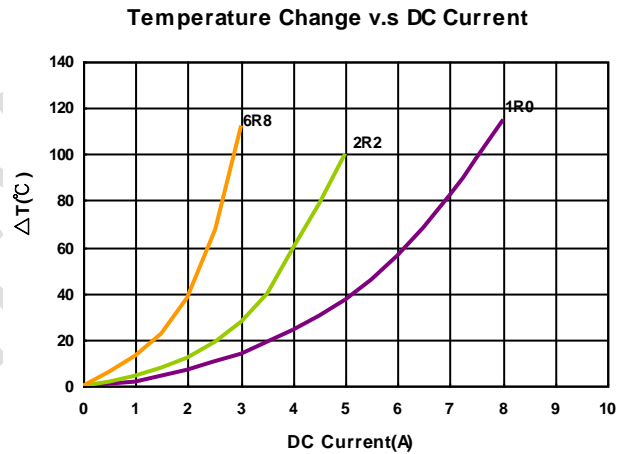
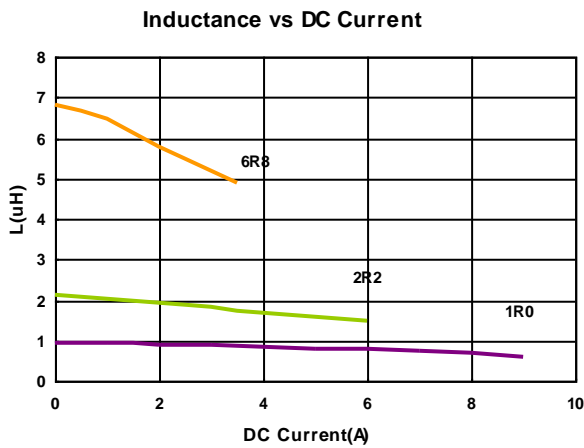

# Molding Power Inductors – MHCC/MHCI Series

## Electrical Characteristics

| Part Number       | Inductance (uH) | Tolerance (±%) | Test Frequency (kHz) | RDC (mΩ) Max | Isat (A)Typ. | Irms (A)Typ. |
|-------------------|-----------------|----------------|----------------------|--------------|--------------|--------------|
| MHCI05015-R47M-R8 | 0.47            | 20             | 100                  | 16           | 12           | 8.0          |
| MHCI05015-R68M-R8 | 0.68            | 20             | 100                  | 23           | 10           | 6.0          |
| MHCI05015-1R0M-R8 | 1.0             | 20             | 100                  | 33           | 8.0          | 5.0          |
| MHCI05015-1R5M-R8 | 1.5             | 20             | 100                  | 50           | 6.0          | 4.0          |
| MHCI05015-2R2M-R8 | 2.2             | 20             | 100                  | 68           | 6.0          | 3.3          |
| MHCI05015-3R3M-R8 | 3.3             | 20             | 100                  | 84           | 5.0          | 3.0          |
| MHCI05015-4R7M-R8 | 4.7             | 20             | 100                  | 135          | 4.0          | 2.5          |
| MHCI05015-5R6M-R8 | 5.6             | 20             | 100                  | 175          | 3.5          | 2.2          |
| MHCI05015-6R8M-R8 | 6.8             | 20             | 100                  | 192          | 3.0          | 2.0          |
| MHCI05015-100M-R8 | 10              | 20             | 100                  | 195          | 2.0          | 1.5          |

**Note: When ordering, please specify tolerance code. Tolerance: M=±20%**

- Operating temperature range - 55°C ~ 125°C(Including self - temperature rise)
- Isat for Inductance drop 30% from its value without current
- I rms for a 40°C temperature rise from 25°C ambient with current
- Absolute maximum voltage 30VDC
- Measure Equipment :  
L : WK 3260B or WK 6500P, 100kHz 0.5V  
RDC : CHEN HWA 502 or CHEN HWA 46502B

**Test Instruments : WK3260B Impedance / Material Analyzer**

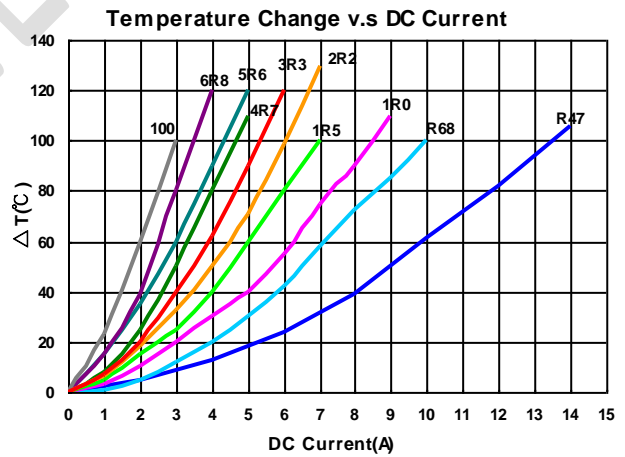
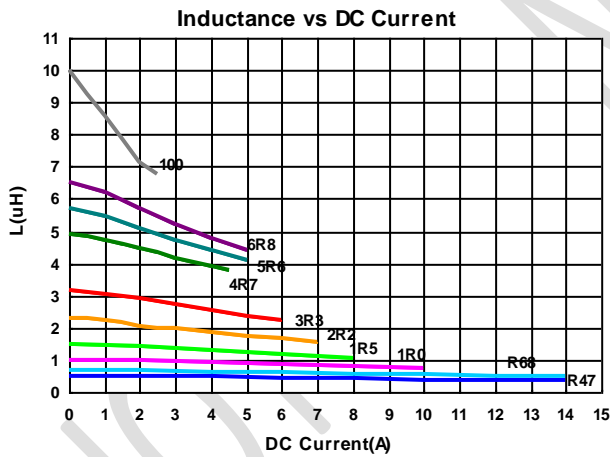

# Molding Power Inductors – MHCC/MHCI Series

## Electrical Characteristics

| Part Number        | Inductance (uH) | Tolerance (±%) | Test Frequency (kHz) | RDC (mΩ) Max | Isat (A)Typ. | Irms (A)Typ. |
|--------------------|-----------------|----------------|----------------------|--------------|--------------|--------------|
| MHCI05015-1R0M-R8A | 1.0             | 20             | 100                  | 23           | 9            | 6.5          |
| MHCI05015-2R2M-R8A | 2.2             | 20             | 100                  | 64           | 6            | 3.3          |
| MHCI05015-4R7M-R8A | 4.7             | 20             | 100                  | 106          | 4            | 3.0          |
| MHCI05015-100M-R8A | 10              | 20             | 100                  | 170          | 3            | 2.0          |

**Note: When ordering, please specify tolerance code. Tolerance: M=±20%**

- Operating temperature range - 55°C ~ 125°C(Including self - temperature rise)
- Isat for Inductance drop 30% from its value without current
- I rms for a 40°C temperature rise from 25°C ambient with current
- Absolute maximum voltage 30VDC
- Measure Equipment :  
 L : WK 3260B or WK 6500P, 100kHz 0.5V  
 RDC : CHEN HWA 502 or CHEN HWA 46502B

**Test Instruments :** WK3260B Impedance / Material Analyzer

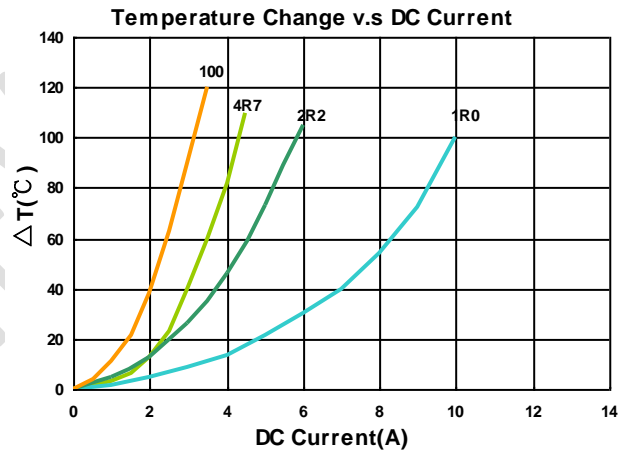
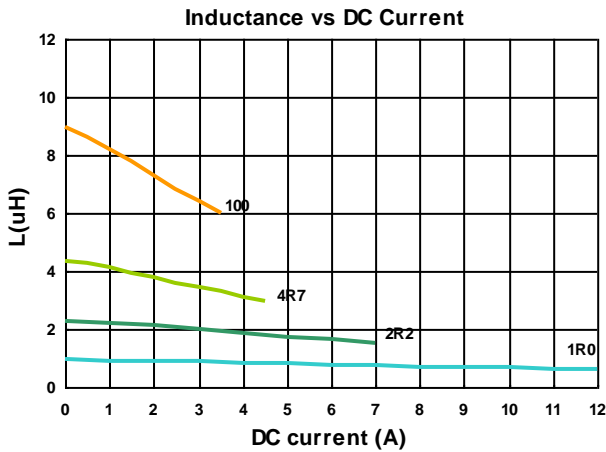



# Molding Power Inductors – MHCC/MHCI Series

## Electrical Characteristics

| Part Number        | Inductance (uH) | Tolerance (±%) | Test Frequency (kHz) | RDC (mΩ) Max | Isat (A)Typ. | Irms (A)Typ. |
|--------------------|-----------------|----------------|----------------------|--------------|--------------|--------------|
| MHCI05018-R47M-R8A | 0.47            | 20             | 100                  | 9.0          | 15.5         | 10.5         |
| MHCI05018-1R0M-R8A | 1.0             | 20             | 100                  | 17           | 9.0          | 8.0          |
| MHCI05018-2R2M-R8A | 2.2             | 20             | 100                  | 35           | 6.5          | 5.0          |
| MHCI05018-3R3M-R8A | 3.3             | 20             | 100                  | 58           | 5.0          | 4.5          |
| MHCI05018-4R7M-R8A | 4.7             | 20             | 100                  | 85           | 4.0          | 3.5          |
| MHCI05018-6R8M-R8A | 6.8             | 20             | 100                  | 120          | 3.4          | 2.8          |
| MHCI05018-100M-R8A | 10              | 20             | 100                  | 155          | 3.0          | 2.5          |

**Note: When ordering, please specify tolerance code. Tolerance: M=±20%**

- Operating temperature range - 55°C ~ 125°C(Including self - temperature rise)
- Isat for Inductance drop 30% from its value without current
- I rms for a 40°C temperature rise from 25°C ambient with current
- Absolute maximum voltage 30VDC
- Measure Equipment :
  - L : WK 3260B or WK 6500P, 100kHz 0.5V
  - RDC : CHEN HWA 502 or CHEN HWA 46502B

**Test Instruments :** WK3260B Impedance / Material Analyzer

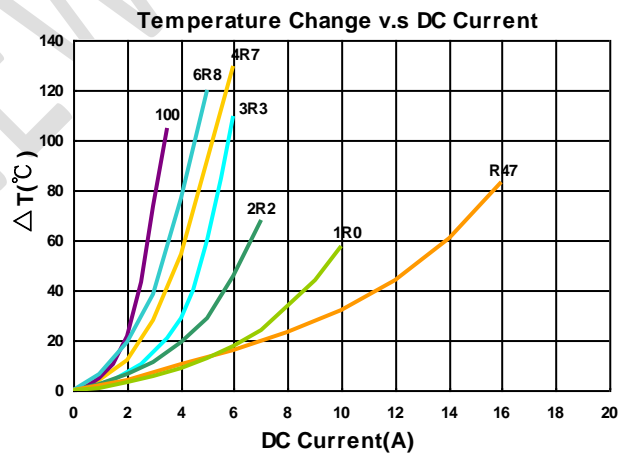
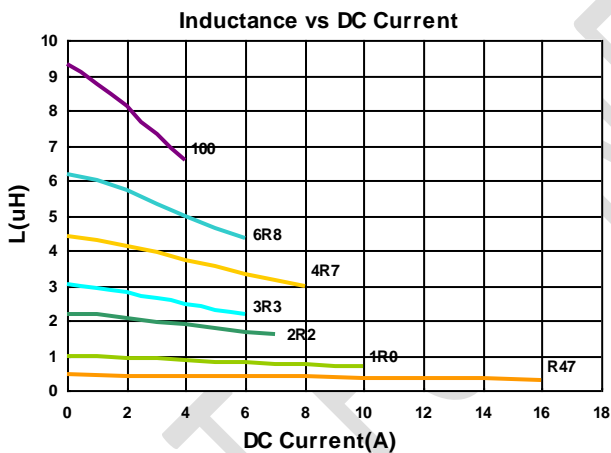

# Molding Power Inductors – MHCC/MHCI Series

## Electrical Characteristics

| Part Number       | Inductance (uH) | Tolerance (±%) | Test Frequency (kHz) | RDC (mΩ) Max | Isat (A)Typ. | Irms (A)Typ. |
|-------------------|-----------------|----------------|----------------------|--------------|--------------|--------------|
| MHCI05020-R47M-R8 | 0.47            | 20             | 100                  | 9            | 15.5         | 10.5         |
| MHCI05020-1R0M-R8 | 1.0             | 20             | 100                  | 30           | 7.0          | 6.0          |
| MHCI05020-1R5M-R8 | 1.5             | 20             | 100                  | 35           | 6.5          | 5.5          |
| MHCI05020-2R2M-R8 | 2.2             | 20             | 100                  | 45           | 6.0          | 4.0          |
| MHCI05020-3R3M-R8 | 3.3             | 20             | 100                  | 60           | 5.5          | 3.5          |
| MHCI05020-4R7M-R8 | 4.7             | 20             | 100                  | 90           | 5.0          | 3.0          |
| MHCI05020-5R6M-R8 | 5.6             | 20             | 100                  | 120          | 4.5          | 2.8          |
| MHCI05020-6R8M-R8 | 6.8             | 20             | 100                  | 125          | 4.5          | 2.8          |
| MHCI05020-100M-R8 | 10              | 20             | 100                  | 180          | 4.0          | 2.3          |

**Note: When ordering, please specify tolerance code. Tolerance: M=±20%**

- Operating temperature range - 55°C ~ 125°C(Including self - temperature rise)
- Isat for Inductance drop 30% from its value without current
- I rms for a 40°C temperature rise from 25°C ambient with current
- Absolute maximum voltage 30VDC
- Measure Equipment :  
L : WK 3260B or WK 6500P, 100kHz 0.5V  
RDC : CHEN HWA 502 or CHEN HWA 46502B

**Test Instruments :** WK3260B Impedance / Material Analyzer

**Inductance v.s DC Current**

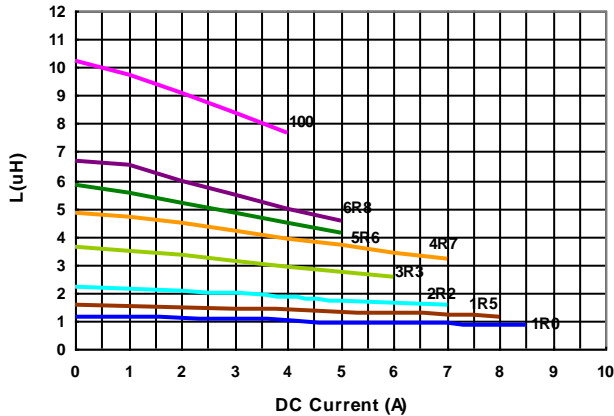

**Temperature Change v.s DC Current**

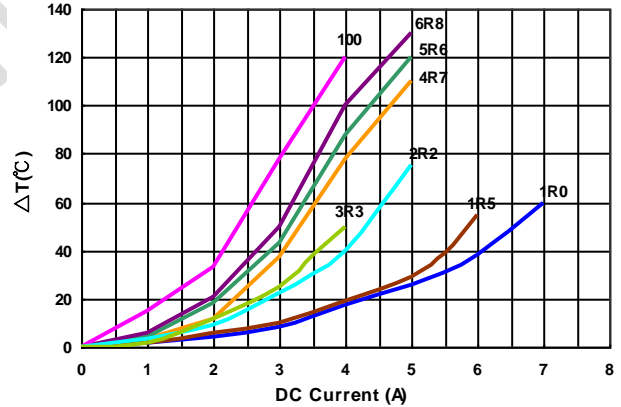

# Molding Power Inductors – MHCC/MHCI Series

## Electrical Characteristics

| Part Number       | Inductance (uH) | Tolerance (±%) | Test Frequency (kHz) | RDC (mΩ)Max | Isat (A)Typ. | Irms (A)Typ. |
|-------------------|-----------------|----------------|----------------------|-------------|--------------|--------------|
| MHCI05030-R20M-R8 | 0.20            | 20             | 100                  | 3.9         | 14.5         | 17.0         |
| MHCI05030-R47M-R8 | 0.47            | 20             | 100                  | 8           | 14           | 10.0         |
| MHCI05030-R68M-R8 | 0.68            | 20             | 100                  | 12          | 14           | 8.0          |
| MHCI05030-1R0M-R8 | 1.0             | 20             | 100                  | 15          | 11           | 7.0          |
| MHCI05030-1R2M-R8 | 1.2             | 20             | 100                  | 15          | 11           | 6.5          |
| MHCI05030-1R5M-R8 | 1.5             | 20             | 100                  | 25          | 10           | 6.0          |
| MHCI05030-2R2M-R8 | 2.2             | 20             | 100                  | 35          | 8            | 5.0          |
| MHCI05030-3R3M-R8 | 3.3             | 20             | 100                  | 46          | 7            | 4.5          |
| MHCI05030-4R7M-R8 | 4.7             | 20             | 100                  | 60          | 6            | 4.0          |
| MHCI05030-6R8M-R8 | 6.8             | 20             | 100                  | 110         | 5            | 3.0          |
| MHCI05030-100M-R8 | 10              | 20             | 100                  | 126         | 4.5          | 1.5          |

**Note: When ordering, please specify tolerance code. Tolerance: M=±20%**

- Operating temperature range - 55°C ~ 125°C(Including self - temperature rise)
- Isat for Inductance drop 30% from its value without current
- I rms for a 40°C temperature rise from 25°C ambient with current
- Absolute maximum voltage 30VDC
- Measure Equipment :  
L : WK 3260B or WK 6500P, 100kHz 0.5V  
RDC : CHEN HWA 502 or CHEN HWA 46502B

**Test Instruments : WK3260B Impedance / Material Analyzer**

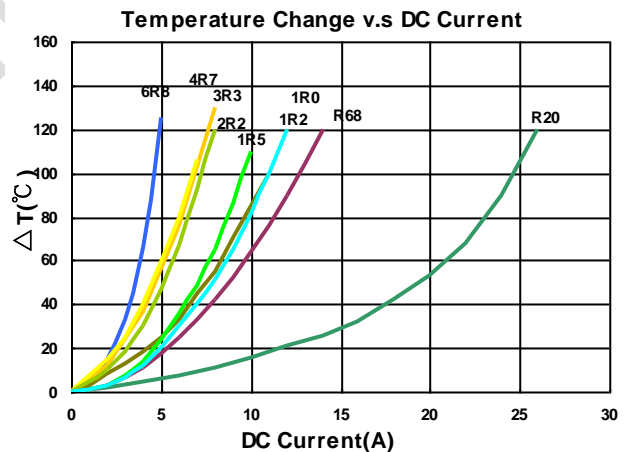
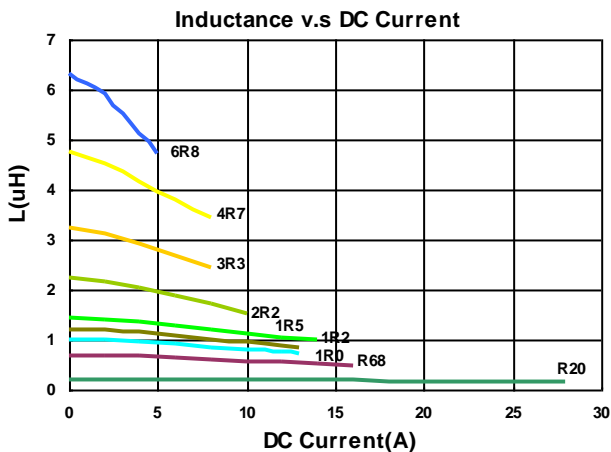

# Molding Power Inductors – MHCC/MHCI Series

## Electrical Characteristics

| Part Number        | Inductance (uH) | Tolerance (±%) | Test Frequency (kHz) | RDC (mΩ) Max | Isat (A)Typ. | Irms (A)Typ. |
|--------------------|-----------------|----------------|----------------------|--------------|--------------|--------------|
| MHCI06012-4R7M-R8A | 4.7             | 20             | 100                  | 122          | 3.5          | 2.5          |
| MHCI06012-6R8M-R8A | 6.8             | 20             | 100                  | 210          | 2.8          | 2.2          |

**Note: When ordering, please specify tolerance code. Tolerance: M=±20%**

- Operating temperature range - 55°C ~ 125°C(Including self - temperature rise)
- Isat for Inductance drop 30% from its value without current
- I rms for a 40°C temperature rise from 25°C ambient with current
- Absolute maximum voltage 30VDC
- Measure Equipment :  
L : WK 3260B or WK 6500P, 100kHz 0.5V  
RDC : CHEN HWA 502 or CHEN HWA 46502B

**Test Instruments :** WK3260B Impedance / Material Analyzer

**Inductance vs DC Current**

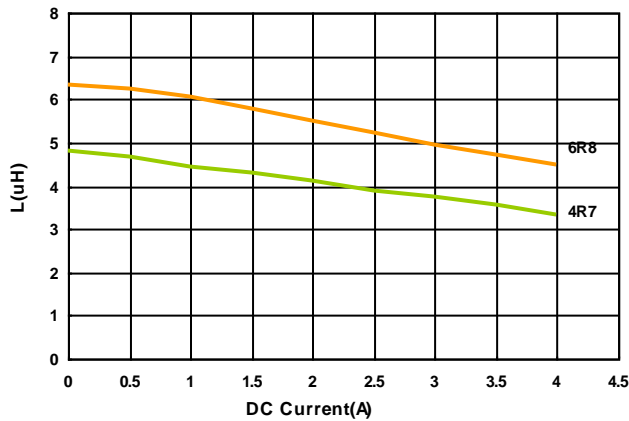

**Temperature Change v.s DC Current**

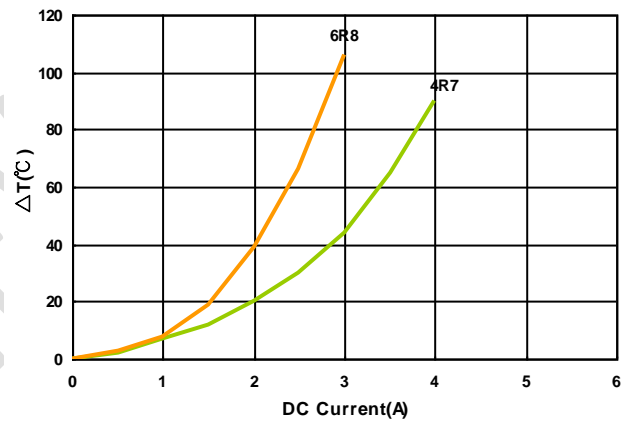

## Molding Power Inductors – MHCC/MHCI Series

### Electrical Characteristics

| Part Number       | Inductance (uH) | Tolerance (±%) | Test Frequency (kHz) | RDC (mΩ)Max | Isat (A)Typ. | Irms (A)Typ. |
|-------------------|-----------------|----------------|----------------------|-------------|--------------|--------------|
| MHCI06015-2R2M-R8 | 2.2             | 20             | 100                  | 54          | 6.0          | 3.5          |
| MHCI06015-3R3M-R8 | 3.3             | 20             | 100                  | 63          | 5.5          | 3.3          |
| MHCI06015-4R7M-R8 | 4.7             | 20             | 100                  | 105         | 4.5          | 3.2          |
| MHCI06015-6R8M-R8 | 6.8             | 20             | 100                  | 140         | 4.0          | 2.5          |

**Note: When ordering, please specify tolerance code. Tolerance: M=±20%**

- Operating temperature range - 55°C ~ 125°C(Including self - temperature rise)
- Isat for Inductance drop 30% from its value without current
- I rms for a 40°C temperature rise from 25°C ambient with current
- Absolute maximum voltage 30VDC
- Measure Equipment :  
L : WK 3260B or WK 6500P, 100kHz 0.5V  
RDC : CHEN HWA 502 or CHEN HWA 46502B

**Test Instruments :** WK3260B Impedance / Material Analyzer

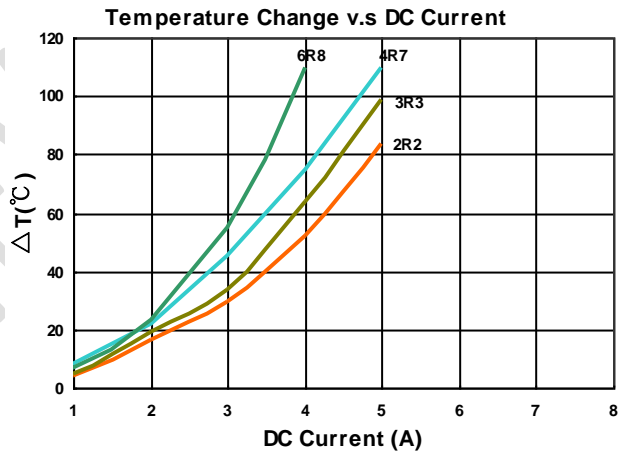
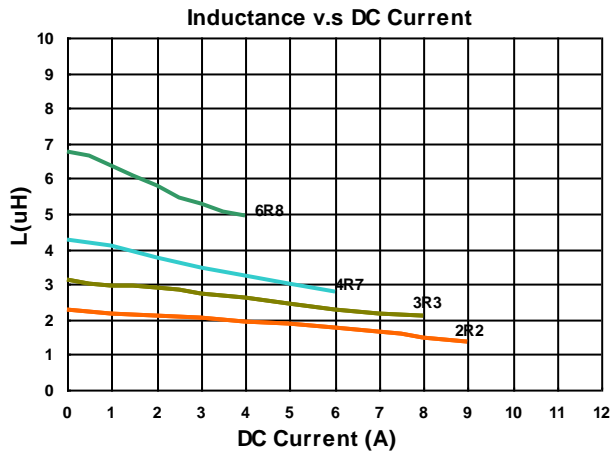

# Molding Power Inductors – MHCC/MHCI Series

## Electrical Characteristics

| Part Number        | Inductance (uH) | Tolerance (±%) | Test Frequency (kHz) | RDC (mΩ)Max | Isat (A)Typ. | Irms (A)Typ. |
|--------------------|-----------------|----------------|----------------------|-------------|--------------|--------------|
| MHCI06015-1R0M-R8A | 1.0             | 20             | 100                  | 21          | 9.0          | 5.5          |
| MHCI06015-3R3M-R8A | 3.3             | 20             | 100                  | 63          | 5.5          | 3.3          |
| MHCI06015-100M-R8A | 10              | 20             | 100                  | 175         | 3.0          | 2.0          |

**Note: When ordering, please specify tolerance code. Tolerance: M=±20%**

- Operating temperature range - 55°C ~ 125°C(Including self - temperature rise)
- Isat for Inductance drop 30% from its value without current
- I rms for a 40°C temperature rise from 25°C ambient with current
- Absolute maximum voltage 30VDC
- Measure Equipment :  
 L : WK 3260B or WK 6500P, 100kHz 0.5V  
 RDC : CHEN HWA 502 or CHEN HWA 46502B

**Test Instruments :** WK3260B Impedance / Material Analyzer

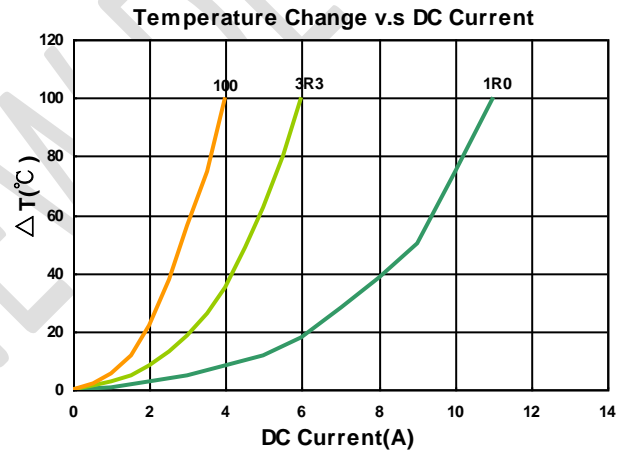
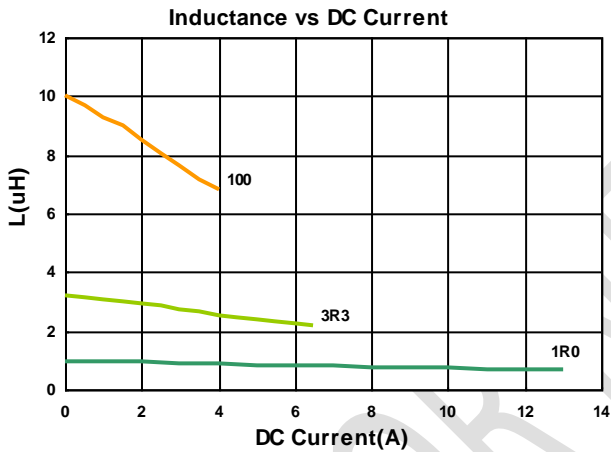

# Molding Power Inductors – MHCC/MHCI Series

## Electrical Characteristics

| Part Number        | Inductance (uH) | Tolerance (±%) | Test Frequency (kHz) | RDC (mΩ)Max | Isat (A)Typ. | Irms (A)Typ. |
|--------------------|-----------------|----------------|----------------------|-------------|--------------|--------------|
| MHCI06018-R22M-R8A | 0.22            | 20             | 100                  | 5.2         | 29           | 14           |
| MHCI06018-R33M-R8A | 0.33            | 20             | 100                  | 6.8         | 22           | 12           |
| MHCI06018-R47M-R8A | 0.47            | 20             | 100                  | 8.4         | 18           | 11           |
| MHCI06018-R68M-R8A | 0.68            | 20             | 100                  | 12.7        | 17           | 9            |
| MHCI06018-1R0M-R8A | 1.0             | 20             | 100                  | 17          | 14           | 7            |
| MHCI06018-1R5M-R8A | 1.5             | 20             | 100                  | 26          | 12           | 6.5          |
| MHCI06018-2R2M-R8A | 2.2             | 20             | 100                  | 35          | 10           | 6.0          |
| MHCI06018-4R7M-R8A | 4.7             | 20             | 100                  | 70          | 5            | 3.5          |
| MHCI06018-6R8M-R8A | 6.8             | 20             | 100                  | 110         | 3.5          | 2.8          |
| MHCI06018-100M-R8A | 10              | 20             | 100                  | 155         | 2.5          | 2.3          |

**Note: When ordering, please specify tolerance code. Tolerance: M=±20%**

- Operating temperature range - 55°C ~ 125°C(Including self - temperature rise)
- Isat for Inductance drop 30% from its value without current
- I rms for a 40°C temperature rise from 25°C ambient with current
- Absolute maximum voltage 30VDC
- Measure Equipment :  
L : WK 3260B or WK 6500P, 100kHz 0.5V  
RDC : CHEN HWA 502 or CHEN HWA 46502B

**Test Instruments : WK3260B Impedance / Material Analyzer**

**Inductance vs DC Current**

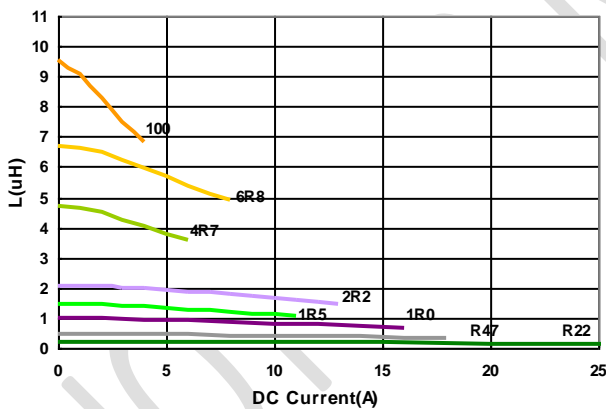

**Temperature Change v.s DC Current**

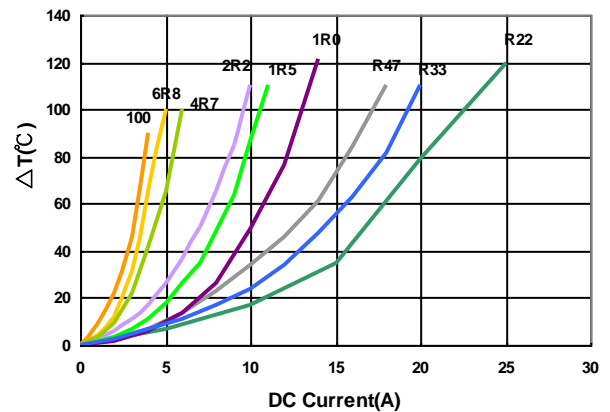

# Molding Power Inductors – MHCC/MHCI Series

## Electrical Characteristics

| Part Number        | Inductance (uH) | Tolerance (±%) | Test Frequency (kHz) | RDC (mΩ)Max | Isat (A)Typ. | Irms (A)Typ. |
|--------------------|-----------------|----------------|----------------------|-------------|--------------|--------------|
| MHCI06024-R22M-R8A | 0.22            | 20             | 100                  | 3.2         | 34           | 21           |
| MHCI06024-R33M-R8A | 0.33            | 20             | 100                  | 4.1         | 24.5         | 18           |
| MHCI06024-R47M-R8A | 0.47            | 20             | 100                  | 5.1         | 22           | 15           |
| MHCI06024-1R0M-R8A | 1.0             | 20             | 100                  | 13.5        | 16           | 9            |
| MHCI06024-1R5M-R8A | 1.5             | 20             | 100                  | 20          | 15           | 9            |
| MHCI06024-2R2M-R8A | 2.2             | 20             | 100                  | 28          | 11           | 7            |
| MHCI06024-3R3M-R8A | 3.3             | 20             | 100                  | 39          | 10           | 5.5          |
| MHCI06024-4R7M-R8A | 4.7             | 20             | 100                  | 50          | 10           | 5.0          |
| MHCI06024-6R8M-R8A | 6.8             | 20             | 100                  | 70          | 6.0          | 4.0          |
| MHCI06024-100M-R8A | 10              | 20             | 100                  | 101         | 4.0          | 3.1          |
| MHCI06024-150M-R8A | 15              | 20             | 100                  | 160         | 3.3          | 2.5          |

**Note: When ordering, please specify tolerance code. Tolerance: M=±20%**

- Operating temperature range - 55°C ~ 125°C(Including self - temperature rise)
- Isat for Inductance drop 30% from its value without current
- I rms for a 40°C temperature rise from 25°C ambient with current
- Absolute maximum voltage 30VDC
- Measure Equipment :  
L : WK 3260B or WK 6500P, 100kHz 0.5V  
RDC : CHEN HWA 502 or CHEN HWA 46502B

**Test Instruments :** WK3260B Impedance / Material Analyzer

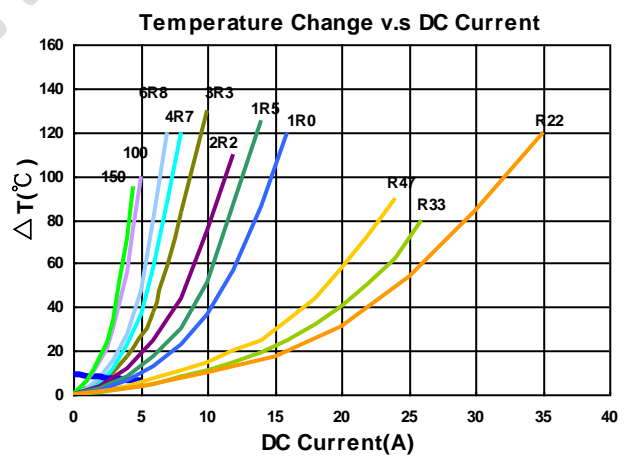
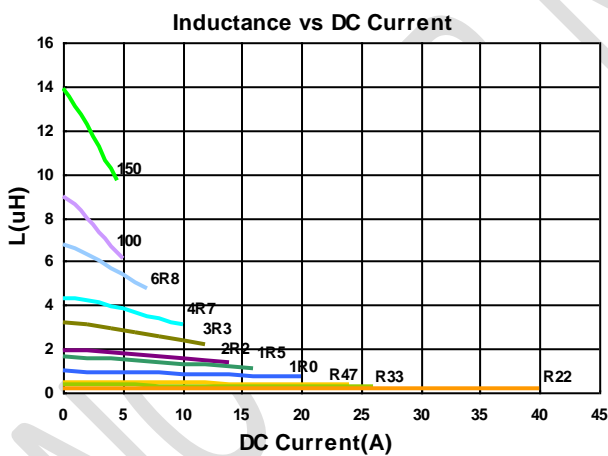



# Molding Power Inductors – MHCC/MHCI Series

## Electrical Characteristics

| Part Number       | Inductance (uH) | Tolerance (±%) | Test Frequency (kHz) | RDC (mΩ) Max | Isat (A)Typ. | Irms (A)Typ. |
|-------------------|-----------------|----------------|----------------------|--------------|--------------|--------------|
| MHCI06030-R10M-R8 | 0.10            | 20             | 100                  | 1.5          | 45           | 37           |
| MHCI06030-R22M-R8 | 0.22            | 20             | 100                  | 2.8          | 40           | 23           |
| MHCI06030-R33M-R8 | 0.33            | 20             | 100                  | 4.2          | 33           | 20           |
| MHCI06030-R47M-R8 | 0.47            | 20             | 100                  | 5.5          | 27           | 16.5         |
| MHCI06030-R56M-R8 | 0.56            | 20             | 100                  | 5.5          | 27           | 16.5         |
| MHCI06030-R68M-R8 | 0.68            | 20             | 100                  | 6.3          | 24           | 15           |
| MHCI06030-R82M-R8 | 0.82            | 20             | 100                  | 8.0          | 23           | 13           |
| MHCI06030-1R0M-R8 | 1.0             | 20             | 100                  | 10           | 22           | 12           |
| MHCI06030-1R5M-R8 | 1.5             | 20             | 100                  | 15           | 18           | 9.5          |
| MHCI06030-1R8M-R8 | 1.8             | 20             | 100                  | 15           | 14           | 9.5          |
| MHCI06030-2R2M-R8 | 2.2             | 20             | 100                  | 20           | 14           | 8.5          |
| MHCI06030-3R3M-R8 | 3.3             | 20             | 100                  | 35           | 12           | 6.0          |
| MHCI06030-4R7M-R8 | 4.7             | 20             | 100                  | 40           | 9            | 5.5          |
| MHCI06030-5R6M-R8 | 5.6             | 20             | 100                  | 40           | 8            | 5.5          |
| MHCI06030-6R8M-R8 | 6.8             | 20             | 100                  | 60           | 8            | 4.5          |
| MHCC06030-8R2M-R7 | 8.2             | 20             | 100                  | 60           | 6            | 4.5          |
| MHCC06030-100M-R7 | 10              | 20             | 100                  | 68           | 5.5          | 4.0          |
| MHCI06030-150M-R8 | 15              | 20             | 100                  | 122          | 5.0          | 3.0          |
| MHCI06030-220M-R8 | 22              | 20             | 100                  | 145          | 3.2          | 3.0          |
| MHCI06030-330M-R8 | 33              | 20             | 100                  | 270          | 3.0          | 2.0          |

**Note: When ordering, please specify tolerance code. Tolerance: M=±20%**

- Operating temperature range - 55°C ~ 125°C(Including self - temperature rise)
- Isat for Inductance drop 30% from its value without current
- I rms for a 40°C temperature rise from 25°C ambient with current
- Absolute maximum voltage 30VDC
- Measure Equipment :  
L : WK 3260B or WK 6500P, 100kHz 0.5V  
RDC : CHEN HWA 502 or CHEN HWA 46502B

**Test Instruments :** WK3260B Impedance / Material Analyzer

**Inductance v.s DC Current**

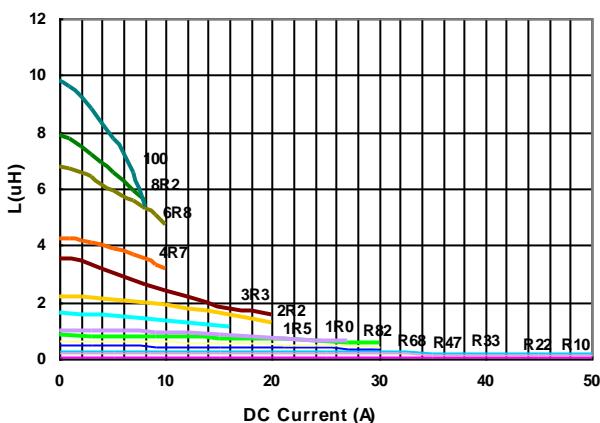

**Temperature Change v.s DC Current**

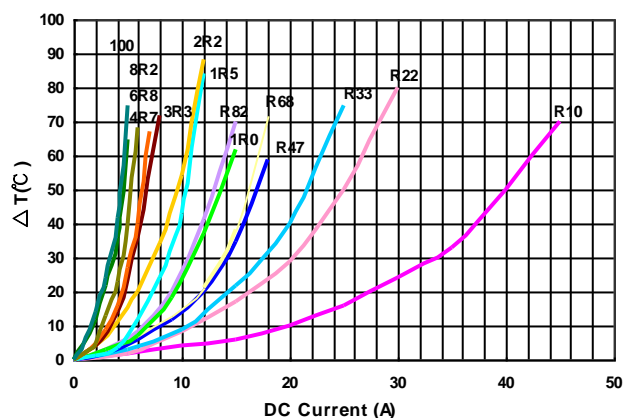

Please be sure to request approval specifications that provide further details of the products. Kindly note that the content of these specifications are subject to change or may be discontinued without prior notice. This product may not be designed/used in medical or high risk applications without Chilisin approval. Please contact our sales department before ordering.

# Molding Power Inductors – MHCC/MHCI Series

## Electrical Characteristics

| Part Number        | Inductance (uH) | Tolerance (±%) | Test Frequency (kHz) | RDC (mΩ)Max | Isat (A)Typ. | Irms (A)Typ. |
|--------------------|-----------------|----------------|----------------------|-------------|--------------|--------------|
| MHCI06030-R10M-R8A | 0.10            | 20             | 100                  | 1.7         | 60           | 32.5         |
| MHCI06030-R15M-R8A | 0.15            | 20             | 100                  | 2.5         | 40           | 30           |
| MHCI06030-R22M-R8A | 0.22            | 20             | 100                  | 3.0         | 34           | 23           |
| MHCI06030-R33M-R8A | 0.33            | 20             | 100                  | 3.5         | 25           | 21           |
| MHCI06030-R36M-R8A | 0.36            | 20             | 100                  | 3.9         | 24           | 20           |
| MHCI06030-R47M-R8A | 0.47            | 20             | 100                  | 4.1         | 20           | 18           |
| MHCI06030-R56M-R8A | 0.56            | 20             | 100                  | 4.5         | 18           | 16.5         |
| MHCI06030-R68M-R8A | 0.68            | 20             | 100                  | 5.3         | 17           | 16           |
| MHCI06030-R82M-R8A | 0.82            | 20             | 100                  | 6.0         | 16           | 14           |
| MHCI06030-1R0M-R8A | 1.0             | 20             | 100                  | 7.4         | 15           | 12           |
| MHCI06030-1R2M-R8A | 1.2             | 20             | 100                  | 10          | 14           | 10           |
| MHCI06030-1R5M-R8A | 1.5             | 20             | 100                  | 12.1        | 14           | 10           |
| MHCI06030-2R2M-R8A | 2.2             | 20             | 100                  | 15          | 10           | 8            |
| MHCI06030-3R3M-R8A | 3.3             | 20             | 100                  | 22          | 9.5          | 6.5          |
| MHCI06030-4R7M-R8A | 4.7             | 20             | 100                  | 33          | 6.5          | 5.5          |
| MHCI06030-6R8M-R8A | 6.8             | 20             | 100                  | 50          | 6            | 4.5          |
| MHCI06030-100M-R8A | 10              | 20             | 100                  | 68          | 5.5          | 4            |

**Note: When ordering, please specify tolerance code. Tolerance: M=±20%**

- Operating temperature range - 55°C ~ 125°C(Including self - temperature rise)
- Isat for Inductance drop 30% from its value without current
- Irms for a 40°C temperature rise from 25°C ambient with current
- Absolute maximum voltage 30VDC
- Measure Equipment :  
 L : WK 3260B or WK 6500P, 100kHz 0.5V  
 RDC : CHEN HWA 502 or CHEN HWA 46502B

**Test Instruments : WK3260B Impedance / Material Analyzer**

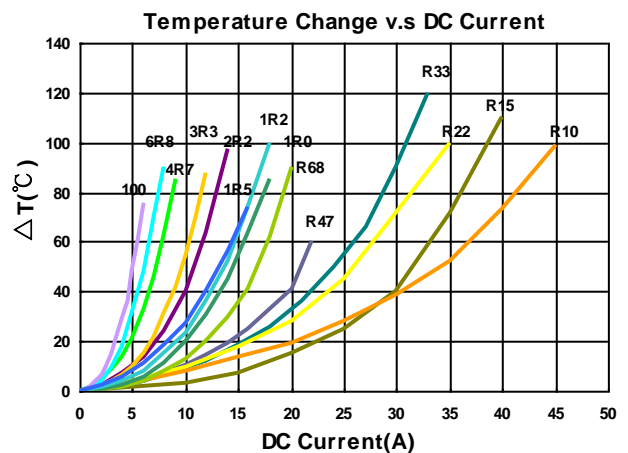
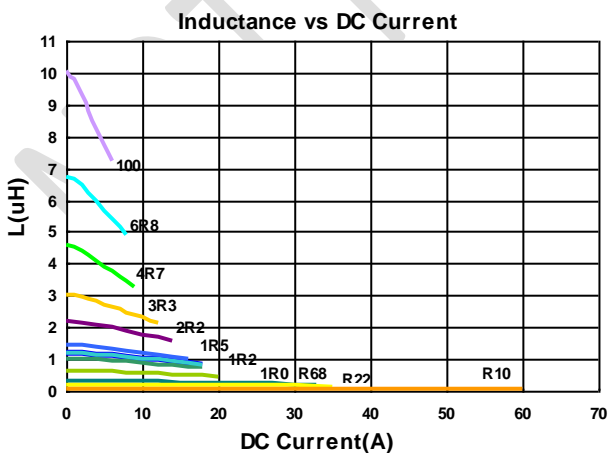

Please be sure to request approval specifications that provide further details of the products. Kindly note that the content of these specifications are subject to change or may be discontinued without prior notice. This product may not be designed/used in medical or high risk applications without Chilisin approval. Please contact our sales department before ordering.

# Molding Power Inductors – MHCC/MHCI Series

## Electrical Characteristics

| Part Number        | Inductance (uH) | Tolerance (±%) | Test Frequency (kHz) | RDC (mΩ) Max | Isat (A)Typ. | Irms (A)Typ. |
|--------------------|-----------------|----------------|----------------------|--------------|--------------|--------------|
| MHCI06050-R56M-R8A | 0.56            | 20             | 100                  | 3.3          | 20           | 20           |
| MHCI06050-1R0M-R8A | 1.0             | 20             | 100                  | 6.5          | 15           | 13           |
| MHCI06050-2R2M-R8A | 2.2             | 20             | 100                  | 12.5         | 12           | 8            |
| MHCI06050-3R3M-R8A | 3.3             | 20             | 100                  | 20.9         | 9            | 7            |
| MHCI06050-4R7M-R8A | 4.7             | 20             | 100                  | 25.0         | 7            | 6.5          |

**Note: When ordering, please specify tolerance code. Tolerance: M=±20%**

- Operating temperature range - 55°C ~ 125°C(Including self - temperature rise)
- Isat for Inductance drop 30% from its value without current
- Irms for a 40°C temperature rise from 25°C ambient with current
- Absolute maximum voltage 30VDC
- Measure Equipment :  
L : WK 3260B or WK 6500P, 100kHz 0.5V  
RDC : CHEN HWA 502 or CHEN HWA 46502B

**Test Instruments :** WK3260B Impedance / Material Analyzer

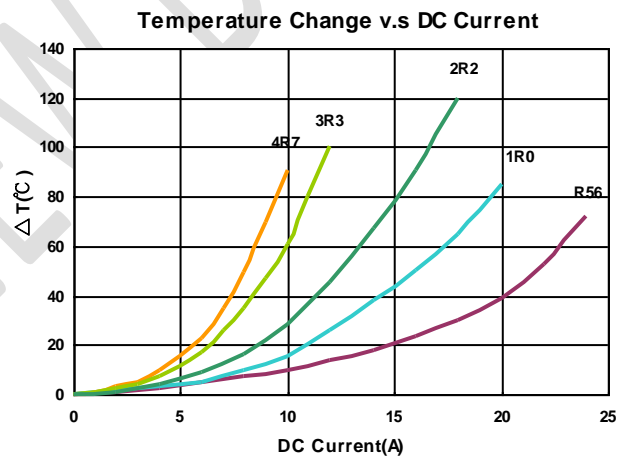
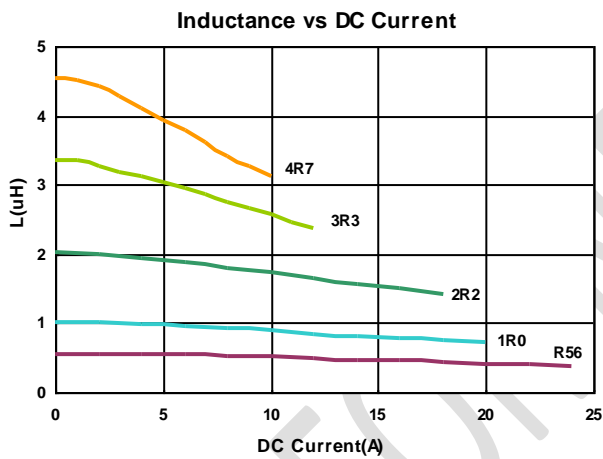

# Molding Power Inductors – MHCC/MHCI Series

## Electrical Characteristics

| Part Number        | Inductance (uH) | Tolerance (±%) | Test Frequency (kHz) | RDC (mΩ) Max | Isat (A)Typ. | Irms (A)Typ. |
|--------------------|-----------------|----------------|----------------------|--------------|--------------|--------------|
| MHCC10030-R33M-R7A | 0.33            | 20             | 100                  | 1.6          | 32           | 23           |
| MHCC10030-1R0M-R7A | 1.0             | 20             | 100                  | 6.0          | 21           | 15           |
| MHCC10030-3R3M-R7A | 3.3             | 20             | 100                  | 16.0         | 14           | 9            |

**Note: When ordering, please specify tolerance code. Tolerance: M=±20%**

- Operating temperature range - 55°C ~ 125°C(Including self - temperature rise)
- Isat for Inductance drop 30% from its value without current
- I rms for a 40°C temperature rise from 25°C ambient with current
- Absolute maximum voltage 30VDC
- Measure Equipment :  
L : WK 3260B or WK 6500P, 100kHz 0.5V  
RDC : CHEN HWA 502 or CHEN HWA 46502B

**Test Instruments :** WK3260B Impedance / Material Analyzer

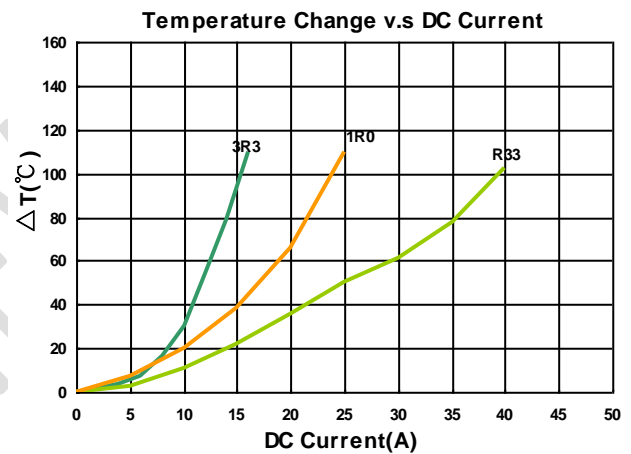
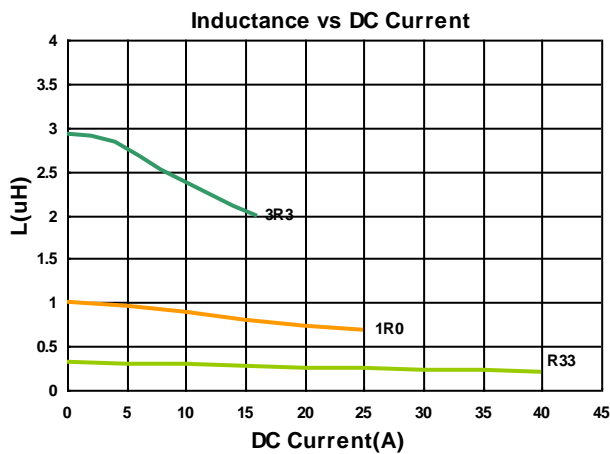

# Molding Power Inductors – MHCC/MHCI Series

## Electrical Characteristics

| Part Number       | Inductance (uH) | Tolerance (±%) | Test Frequency (kHz) | RDC (mΩ) Max | Isat (A)Typ. | Irms (A)Typ. |
|-------------------|-----------------|----------------|----------------------|--------------|--------------|--------------|
| MHCC10040-R22M-R7 | 0.22            | 20             | 100                  | 0.6          | 45           | 35           |
| MHCC10040-R36M-R7 | 0.36            | 20             | 100                  | 1.2          | 42           | 34           |
| MHCC10040-R45M-R7 | 0.45            | 20             | 100                  | 1.2          | 38           | 33           |
| MHCC10040-R47M-R7 | 0.47            | 20             | 100                  | 1.2          | 38           | 33           |
| MHCC10040-R56M-R7 | 0.56            | 20             | 100                  | 1.55         | 32           | 27           |
| MHCC10040-R68M-R7 | 0.68            | 20             | 100                  | 1.55         | 30           | 27           |
| MHCC10040-R90M-R7 | 0.90            | 20             | 100                  | 3.0          | 20           | 22           |
| MHCC10040-1R0M-R7 | 1.0             | 20             | 100                  | 3.1          | 26           | 20           |
| MHCC10040-1R5M-R7 | 1.5             | 20             | 100                  | 4.2          | 22           | 16           |
| MHCC10040-1R8M-R7 | 1.8             | 20             | 100                  | 5            | 16           | 15.3         |
| MHCC10040-2R2M-R7 | 2.2             | 20             | 100                  | 7            | 16           | 14           |
| MHCC10040-3R3M-R7 | 3.3             | 20             | 100                  | 13.2         | 12           | 11           |
| MHCC10040-4R7M-R7 | 4.7             | 20             | 100                  | 16.5         | 12           | 9            |
| MHCC10040-6R8M-R7 | 6.8             | 20             | 100                  | 25           | 10           | 6            |
| MHCC10040-8R2M-R7 | 8.2             | 20             | 100                  | 30           | 9            | 6            |
| MHCC10040-100M-R7 | 10              | 20             | 100                  | 30           | 7            | 6.5          |
| MHCC10040-150M-R7 | 15              | 20             | 100                  | 45           | 6            | 6.25         |
| MHCC10040-220M-R7 | 22              | 20             | 100                  | 64           | 4.5          | 4.5          |

**Note: When ordering, please specify tolerance code. Tolerance: M=±20%**

- Operating temperature range - 55°C ~ 125°C(Including self - temperature rise)
- Isat for Inductance drop 30% from its value without current
- I rms for a 40°C temperature rise from 25°C ambient with current
- Absolute maximum voltage 30VDC
- Measure Equipment :  
 L : WK 3260B or WK 6500P, 100kHz 0.5V  
 RDC : CHEN HWA 502 or CHEN HWA 46502B

**Test Instruments :** WK3260B Impedance / Material Analyzer

Inductance v.s DC Current

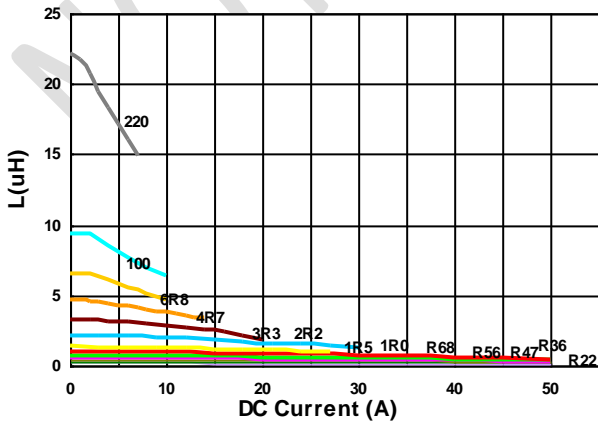

Temperature Change v.s DC Current

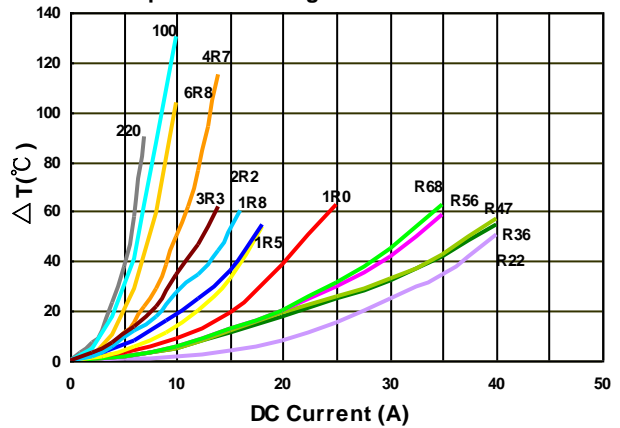

# Molding Power Inductors – MHCC/MHCI Series

## Electrical Characteristics

| Part Number       | Inductance (uH) | Tolerance (±%) | Test Frequency (kHz) | RDC (mΩ) Max | Isat (A)Typ. | Irms (A)Typ. |
|-------------------|-----------------|----------------|----------------------|--------------|--------------|--------------|
| MHCC12050-R47M-R7 | 0.47            | 20             | 100                  | 1.2          | 46           | 37           |
| MHCC12050-1R0M-R7 | 1.0             | 20             | 100                  | 2.5          | 37           | 29           |
| MHCC12050-1R5M-R7 | 1.5             | 20             | 100                  | 3.0          | 28           | 28           |
| MHCC12050-4R7M-R7 | 4.7             | 20             | 100                  | 11.5         | 16           | 11           |
| MHCC12050-6R8M-R7 | 6.8             | 20             | 100                  | 22           | 14           | 9            |
| MHCC12050-100M-R7 | 10              | 20             | 100                  | 35           | 13           | 7            |

**Note: When ordering, please specify tolerance code. Tolerance: M=±20%**

- Operating temperature range - 55°C ~ 125°C(Including self - temperature rise)
- Isat for Inductance drop 30% from its value without current
- I rms for a 40°C temperature rise from 25°C ambient with current
- Absolute maximum voltage 30VDC
- Measure Equipment :  
 L : WK 3260B or WK 6500P, 100kHz 0.5V  
 RDC : CHEN HWA 502 or CHEN HWA 46502B

**Test Instruments :** WK3260B Impedance / Material Analyzer

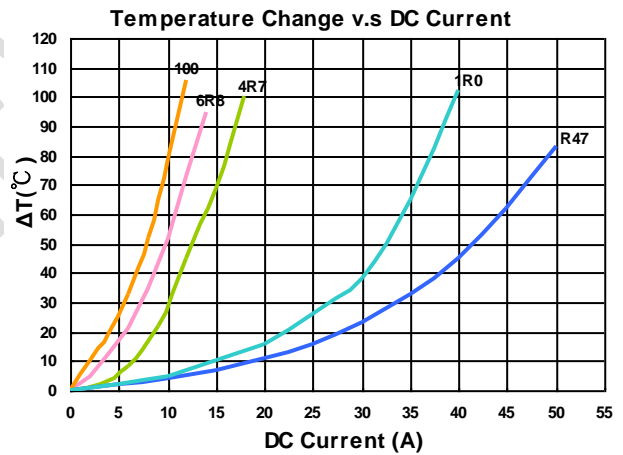
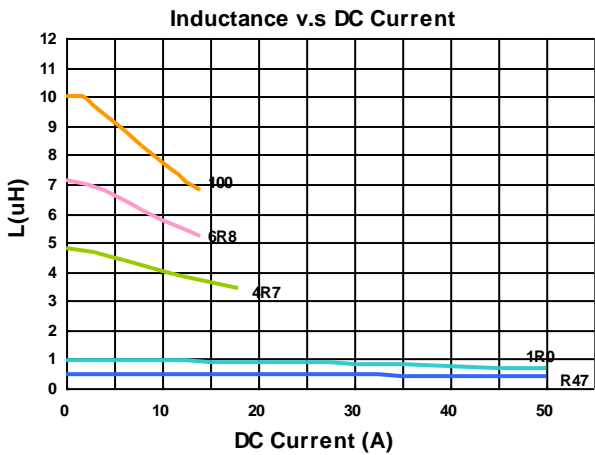

# Molding Power Inductors – MHCC/MHCI Series

## Electrical Characteristics

| Part Number        | Inductance (uH) | Tolerance (±%) | Test Frequency (kHz) | RDC (mΩ) Max | Isat (A)Typ. | Irms (A)Typ. |
|--------------------|-----------------|----------------|----------------------|--------------|--------------|--------------|
| MHCC12060-100M-R7A | 10              | 20             | 100                  | 20.7         | 12.5         | 10           |
| MHCC12060-150M-R7A | 15              | 20             | 100                  | 29.0         | 9.0          | 6.0          |
| MHCC12060-220M-R7A | 22              | 20             | 100                  | 39.5         | 7.5          | 5.0          |
| MHCC12060-330M-R7A | 33              | 20             | 100                  | 75           | 6.0          | 4.0          |

**Note: When ordering, please specify tolerance code. Tolerance: M=±20%**

- Operating temperature range - 55°C ~ 125°C(Including self - temperature rise)
- Isat for Inductance drop 30% from its value without current
- I rms for a 40°C temperature rise from 25°C ambient with current
- Absolute maximum voltage 30VDC
- Measure Equipment :  
 L : WK 3260B or WK 6500P, 100kHz 0.5V  
 RDC : CHEN HWA 502 or CHEN HWA 46502B

**Test Instruments :** WK3260B Impedance / Material Analyzer

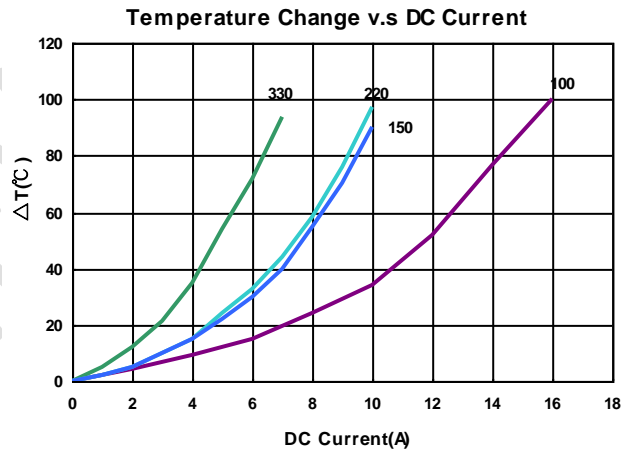
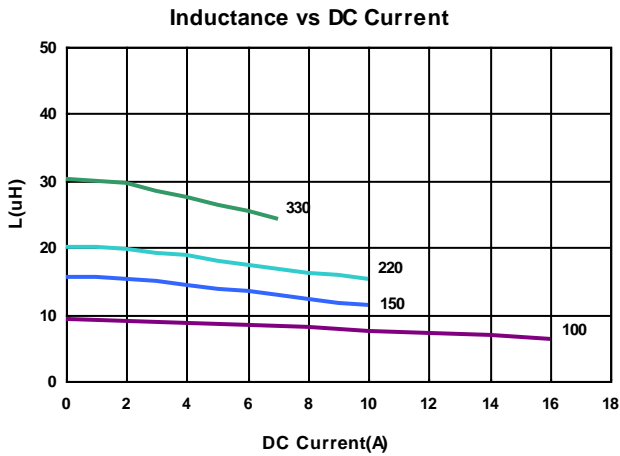

## Packaging Specifications

Tape Dimensions

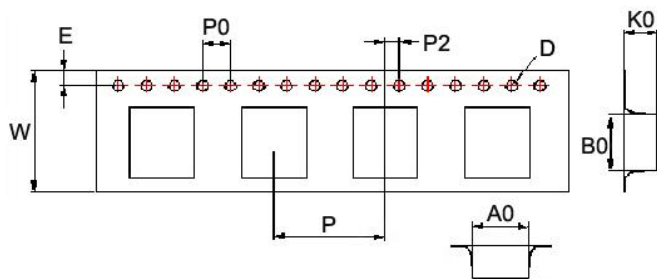

Tape Material

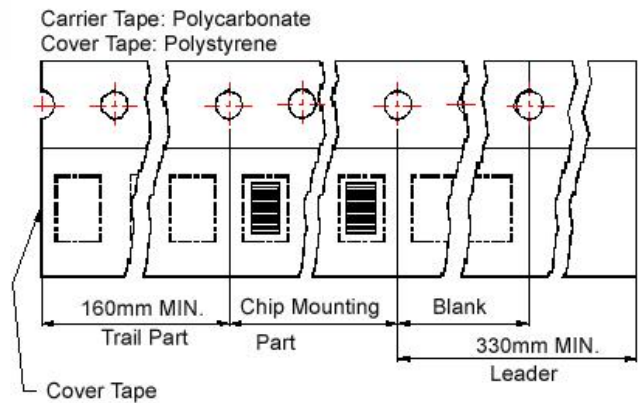

Reel Dimensions

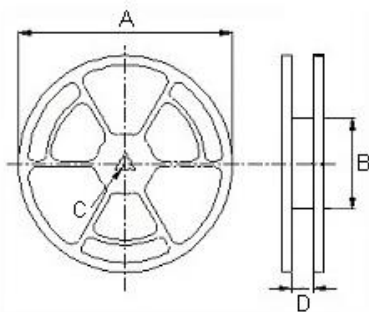

Dimensions in mm

| TYPE  | Tape Dimensions |      |      |      |      |    |    |    |    | Reel Dimensions |     |    |      | Quantity<br>PCS / REEL |
|-------|-----------------|------|------|------|------|----|----|----|----|-----------------|-----|----|------|------------------------|
|       | A0              | B0   | K0   | D    | E    | W  | P  | P0 | P2 | A               | B   | C  | D    |                        |
| 04012 | 4.6             | 5.0  | 1.5  | 1.55 | 1.75 | 12 | 8  | 4  | 2  | 330             | 100 | 13 | 13.4 | 2000                   |
| 04015 | 4.4             | 4.9  | 1.8  | 1.55 | 1.75 | 12 | 8  | 4  | 2  | 330             | 100 | 13 | 13.4 | 2000                   |
| 04020 | 4.3             | 4.9  | 2.4  | 1.55 | 1.75 | 12 | 8  | 4  | 2  | 330             | 100 | 13 | 13.4 | 2000                   |
| 05012 | 5.9             | 6.2  | 1.5  | 1.55 | 1.75 | 16 | 12 | 4  | 2  | 330             | 100 | 13 | 16.0 | 1000                   |
| 05015 | 5.7             | 6.1  | 1.9  | 1.55 | 1.75 | 16 | 12 | 4  | 2  | 330             | 100 | 13 | 16.0 | 1000                   |
| 05018 | 5.9             | 6.2  | 2.2  | 1.55 | 1.75 | 16 | 12 | 4  | 2  | 330             | 100 | 13 | 16.0 | 1000                   |
| 05020 | 5.7             | 5.9  | 2.4  | 1.55 | 1.75 | 16 | 12 | 4  | 2  | 330             | 100 | 13 | 16.0 | 1000                   |
| 05030 | 5.9             | 6.2  | 3.4  | 1.55 | 1.75 | 16 | 12 | 4  | 2  | 330             | 100 | 13 | 16.0 | 1000                   |
| 06012 | 6.9             | 7.6  | 1.6  | 1.55 | 1.75 | 16 | 12 | 4  | 2  | 330             | 100 | 13 | 16.0 | 1000                   |
| 06015 | 6.9             | 7.6  | 1.9  | 1.55 | 1.75 | 16 | 12 | 4  | 2  | 330             | 100 | 13 | 16.0 | 1000                   |
| 06018 | 6.9             | 7.6  | 2.2  | 1.55 | 1.75 | 16 | 12 | 4  | 2  | 330             | 100 | 13 | 16.0 | 1000                   |
| 06024 | 6.9             | 7.6  | 2.9  | 1.55 | 1.75 | 16 | 12 | 4  | 2  | 330             | 100 | 13 | 16.0 | 1000                   |
| 06030 | 6.9             | 7.6  | 3.4  | 1.55 | 1.75 | 16 | 12 | 4  | 2  | 330             | 100 | 13 | 16.0 | 1000                   |
| 06050 | 6.9             | 7.6  | 5.4  | 1.55 | 1.75 | 16 | 12 | 4  | 2  | 330             | 100 | 13 | 16.0 | 1000                   |
| 10030 | 10.6            | 11.7 | 3.25 | 1.55 | 1.75 | 24 | 16 | 4  | 2  | 330             | 100 | 13 | 24.4 | 500                    |
| 10040 | 10.6            | 11.7 | 4.25 | 1.55 | 1.75 | 24 | 16 | 4  | 2  | 330             | 100 | 13 | 24.4 | 500                    |
| 12050 | 13              | 14   | 5.25 | 1.55 | 1.75 | 24 | 16 | 4  | 2  | 330             | 100 | 13 | 24.4 | 500                    |
| 12060 | 13              | 14   | 6.25 | 1.55 | 1.75 | 24 | 16 | 4  | 2  | 330             | 100 | 13 | 24.4 | 500                    |