



ISO9001 & ISO14001 & TS16949 **CHILISIN ELECTRONICS CORP.**

Halogen Free & RoHs Compliance

SPECIFICATION FOR APPROVAL

CUSTOMER : _____

CUSTOMER P/N : _____

OUR DWG No : _____

QUANTITY : 0 Pcs. **DATE :** 2014/06/09

ITEM : MHCD252010A-R33M-A8L

**SPECIFICATION
ACCEPTED BY:**

COMPONENT ENGINEER	
ELECTRICAL ENGINEER	
MECHANICAL ENGINEER	
APPROVED	
REJECTED	

奇力新電子股份有限公司
Chilisin Electronic sCorp
No. 29, Alley 301, Tehhsin Rd.,
Hukou,Hsinchu 303, Taiwan
TEL : +886-3- 599-2646
FAX : +886-3- 599-9176
E-mail : sales@chilisin.com.tw
http : //www.chilisin.com.tw

東莞奇力新電子有限公司
Chilisin Electronics (Dongguan) Co., Ltd.
No. 78, Puxing Rd., Yuliangwei Administration Area,
Qingxi Town, Dongguan City, Guangdong,China
TEL : +86-769-8773-0251~3
FAX : +86-769-8773-0232
E-mail : cect@chilisin.com.tw

奇力新電子(河南)有限公司
Chilisin Electronics (Henan) Co., Ltd.
XiuWu Xian, industry gathering area
JiaoZuo, Henan China
Postal Code:454350
TEL:+86-391-717-0682
FAX:+86-391-717-0666

奇力新電子(蘇州)有限公司
Chilisin Electronics (Suzhou) Co., Ltd.
No.143,Song Shan Rd., Suzhou New District,
Suzhou,China
Postal Code:215129
TEL:+86-512-6841-2350
FAX:+86-512-6841-2356
E-mail: suzhou@chilisin.com.tw

DRAWN BY
張鈺雯 chang.yuwen

CHECKED BY
溫美玲 ling

APPROVED BY
張鈺雯 chang.yuwen

MHCD252010A Series Specification

1 Scope: This specification applies to Alloy Molding power inductors

2 Part Numbering: Product Identification

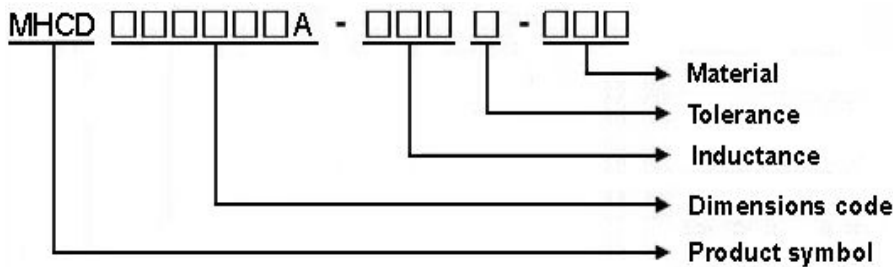

3 Rating:

Operating Temperature: - 4 0 °C ~ 1 2 5 °C (Including self - temperature rise)

Storage Temperature: - 4 0 °C ~ 1 2 5 °C (after PCB)

- 5 °C ~ 3 5 °C, Humidity 4 5 % ~ 8 5 % (before PCB)

4 Marking:



5 Standard Testing Condition

	Unless otherwise specified	In case of doubt
Temperature	Ordinary Temperature(15 to 35°C)	20±2°C
Humidity	Ordinary Humidity(25 to 85% RH)	60 to 70 % RH

MHCD252010A Series Specification

6 Configuration and Dimensions:

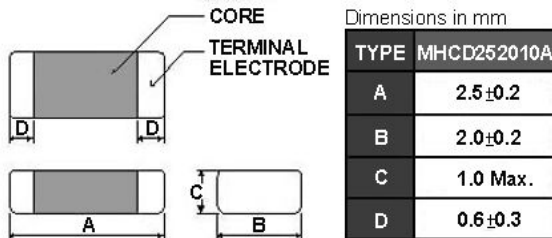

7 ELECTRICAL CHARACTERISTICS :

Part No.	Inductance (uH)	Test Freq.	I _{rms} (A) Max.(Typ)	I _{sat} (A) Max.(Typ)	RDC(mΩ) Max.(Typ)	Tolerance (±%)
MHCD252010A-R33M-A8L	0.33	2MHz,0.2V	4.0(4.5)	5.3(6.2)	25(22)	20

NOTE:

1. Operating temperature range — 4 0 °C ~ 1 2 5 °C (Including self - temperature rise)
2. I_{rms} DC current (A) that will cause an approximate ΔT of 40°C.
3. I_{sat} DC current (A) that will cause L_o to drop approximately 30%
4. All test data is referenced to 25°C ambient

MHCD252010A Series Specification

8 MHCD252010A Series

8.1 Construction:

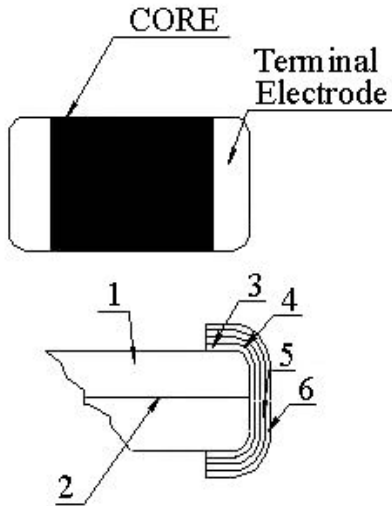





8.2 Material List:

NO	Part	Description
1	Core	Metal Power
2	Wire	Copper wire
3	Sputter/Plating	Cu
4	Silver Electrode	Ag
5	Plating	Ni
6	Plating	Sn

MHCD252010A Series Specification

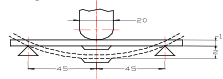
9 Reliability Of Molding power inductors

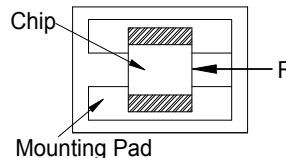
1-1.Mechanical Performance

Item	Specification	Test Method
1-1-1 Flexure Strength	The forces applied on the right conditions must not damage the terminal electrode and the ferrite	Test device shall be soldered on the substrate Substrate Dimension: 100x40x1.6mm Deflection: 2.0mm Keeping Time: 30sec 
1-1-2 Vibration		Test device shall be soldered on the substrate Oscillation Frequency: 10 to 55 to 10Hz for 1min Amplitude: 1.5mm Time: 2hrs for each axis (X, Y & Z), total 6hrs
1-1-3 Resistance to Soldering Heat	Appearance: No damage More than 75% of the terminal electrode should be covered with solder. Inductance: within $\pm 20\%$ of initial value	Pre-heating: 150°C, 1min Solder Composition: Sn/Ag3.0/Cu0.5(Pb-Free) Solder Temperature: 260 \pm 5°C Immersion Time: 10 \pm 1sec 
1-1-4 Solder ability	The electrodes shall be at least 95% covered with new solder coating	Pre-heating: 150°C, 1min Solder Composition: Sn/Ag3.0/Cu0.5(Pb-Free) Solder Temperature: 245 \pm 5°C Immersion Time: 4 \pm 1sec
1-1-5 Terminal Strength Test	No split termination 	Test device shall be soldered on the substrate, then apply a force in the direction of the arrow. Force : 5N Keeping Time: 10 \pm 1sec 

1-2.Environmental Performance

No	Item	Specification	Test Method		
1-2-1	Temperature Cycle	Appearance: No damage Inductance: within $\pm 20\%$ of initial value	One cycle:		
			Step	Temperature (°C)	Time (min)
			1	-40 \pm 3	30
			2	25 \pm 2	2
			3	125 \pm 3	30
4	25 \pm 2	2			
			Total: 100cycles		
			Measured after exposure in the room condition for 24hrs		
1-2-2	Humidity Resistance		Temperature: 60 \pm 2°C Relative Humidity: 90 ~ 95% / Time: 500hrs Measured after exposure in the room condition for 12hrs		
1-2-3	High Temperature Resistance		Temperature: 85 \pm 3°C Relative Humidity: 0% / Time: 500hrs Measured after exposure in the room condition for 12hrs		
1-2-4	Low Temperature Resistance		Temperature: -40 \pm 3°C Relative Humidity: 0% / Time: 500hrs Measured after exposure in the room condition for 12hrs		

MHCD252010A Series Specification

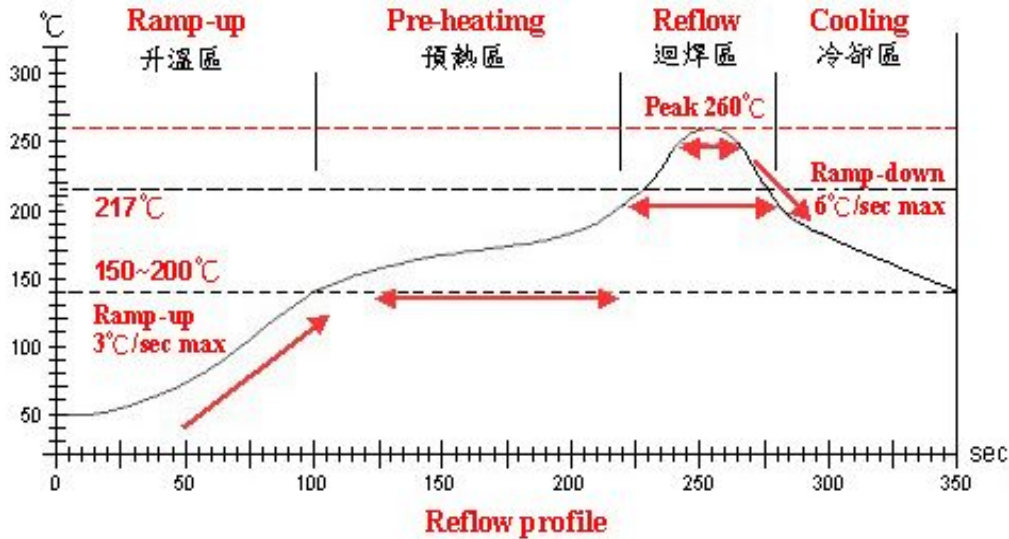

Lead-Free(LF) 標準溫度分析範圍

Refer to J-STD-020C

管制項目 Item.	升溫區 Ramp-up	預熱區 Pre-heating	迴焊區 Reflow	Peak Temp	冷卻區 Cooling
溫度範圍 Temp. scope	R.T. ~ 150°C	150°C ~ 200°C	217°C	260±5°C	Peak Temp. ~ 150°C
標準時間 Time spec.	—	60 ~ 180 sec	60 ~ 150sec	20 ~ 40 sec	—
實際時間 Time result	—	75 ~ 100 sec	90 ~ 120sec	20 ~ 35 sec	—

NOTE :

1. Re-flow possible times : within 2 times
2. Nitrogen adopted is recommended while in re-flow

MHCD252010A Series Specification

PACKAGING

11.1 Packaging -Cover tape

The force for tearing off cover tape is 10 to 100 grams in the arrow direction.

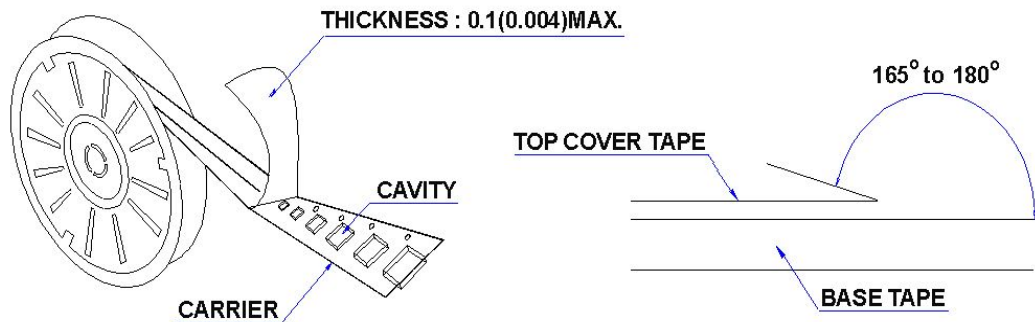

11.2 Packaging Quantity

TYPE	BULK	PCS/REEL
MHCD252010A	✓	3000

11.3 Reel Dimensions

Dimensions in mm

TYPE	A	B	C	D
MHCD252010A	178	60	12	1.5

MHCD252010A Series Specification

PACKAGING

11.4 Tape Dimensions in mm

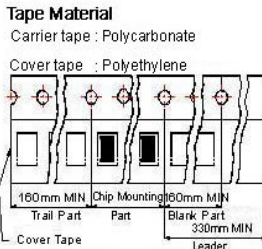
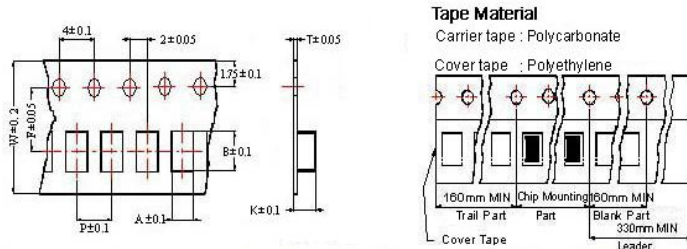

TYPE	A	B	T	W	P	F	K
MHCD252010A	2.25	2.80	0.22	8	4	3.5	1.35

Recommended Pattern

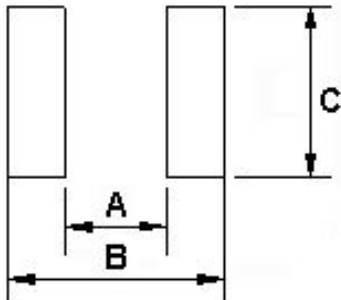

Dimensions in mm

TYPE	A	B	C
MHCD252010A	1.2	2.8	2.0

Note:

1. Please make sure that your product is has been evaluated and confirmed against your specifications when our product is mounted to your product.
2. Do not knock nor drop.
3. All the items and parameters in this product specification have been prescribed on the premise that our product is used for the purpose, under the condition and in the environment agreed upon between you and us. You are requested not to use our product deviating from such agreement.
4. Please keep the distance between transformer/coil and other components (refer to the standard IEC 950)