

N-Channel Enhancement Mode MOSFET

MTB095N10KRL3

BV_{DSS}	100V
I_D @ V_{GS}=10V, T_A=25°C	3.3A
R_{DSON} @ V_{GS}=10V, I_D=2A	107mΩ (typ.)
R_{DSON} @ V_{GS}=4.5V, I_D=2A	127mΩ (typ.)

Features

- Low Gate Charge
- Simple Drive Requirement
- ESD protected gate
- Pb-free lead plating & Halogen-free package

Equivalent Circuit

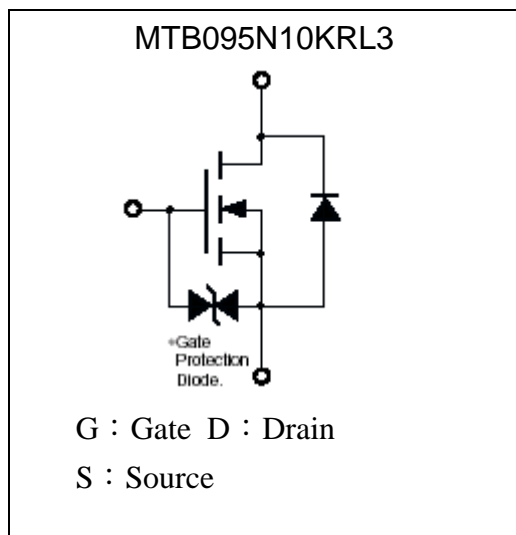

Outline

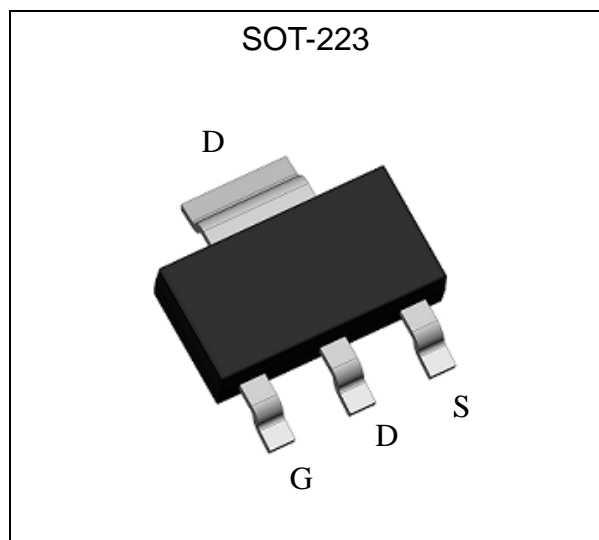

Ordering Information

Device	Package	Shipping
MTB095N10KRL3-0-T3-G	SOT-223 (Pb-free lead plating & Halogen-free package)	2500 pcs / Tape & Reel

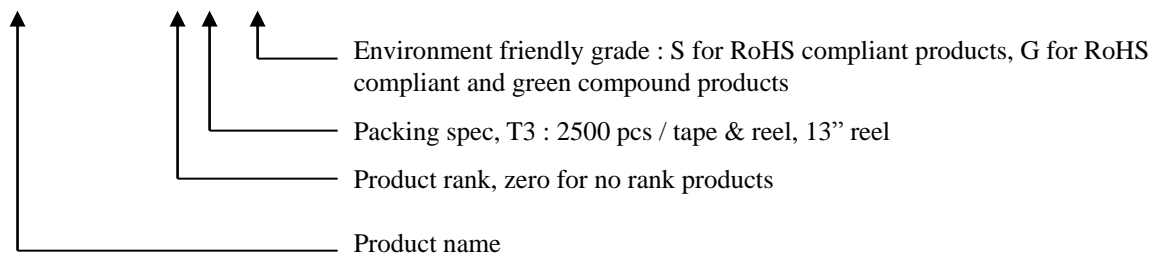



Absolute Maximum Ratings (T_c=25°C, unless otherwise noted)

Parameter	Symbol	Limits	Unit
Drain-Source Voltage	V _{DS}	100	V
Gate-Source Voltage	V _{GS}	±20	
Continuous Drain Current @ T _A =25°C, V _{GS} =10V	I _D	3.3	A
Continuous Drain Current @ T _A =70°C, V _{GS} =10V		2.6	
Pulsed Drain Current *1	I _{DM}	16	
Avalanche Current @ L=0.1mH	I _{AS}	6	mJ
Avalanche Energy @ L=1mH, I _D =6A, V _{DD} =50V *2	E _{AS}	18	
Repetitive Avalanche Energy @ L=0.05mH	E _{AR}	0.625	
Total Power Dissipation @T _A =25°C	P _D	2.5	W
Total Power Dissipation @T _A =70°C		1.6	
Operating Junction and Storage Temperature Range	T _j , T _{stg}	-55~+150	°C

Note : *1. Pulse width limited by maximum junction temperature
 *2. Guaranteed by design, not by 100% test.

Thermal Data

Parameter	Symbol	Value	Unit
Thermal Resistance, Junction-to-case, max	R _{θJC}	18.5	°C/W
Thermal Resistance, Junction-to-ambient, max	R _{θJA}	50 (Note)	

Note : When mounted on a 1 in² pad of 2 oz. copper.

Characteristics (T_c=25°C, unless otherwise specified)

Symbol	Min.	Typ.	Max.	Unit	Test Conditions
Static					
BV _{DSS}	100	-	-	V	V _{GS} =0V, I _D =250μA
V _{GS(th)}	1.2	-	2.6		V _{DS} =V _{GS} , I _D =250μA
G _{FS} *1	-	2.9	-	S	V _{DS} =10V, I _D =1A
I _{GSS}	-	-	±10	μA	V _{GS} =±16V, V _{DS} =0V
I _{DSS}	-	-	1		V _{DS} =80V, V _{GS} =0V
	-	-	25		V _{DS} =80V, V _{GS} =0V, T _j =125°C
R _{DS(ON)} *1	-	107	140	mΩ	V _{GS} =10V, I _D =2A
	-	127	180		V _{GS} =4.5V, I _D =2A
Dynamic					
Q _g *1, 2	-	6.7	10	nC	V _{DS} =80V, V _{GS} =10V, I _D =2A
Q _{gs} *1, 2	-	1.1	1.7		
Q _{gd} *1, 2	-	1.6	2.4		
t _{d(ON)} *1, 2	-	5.2	7.8	ns	V _{DS} =50V, I _D =2A, V _{GS} =10V, R _G =1Ω
t _r *1, 2	-	16.6	24.9		
t _{d(OFF)} *1, 2	-	17	25.5		
t _f *1, 2	-	5.2	7.8		

Ciss	-	301	452	pF	V _{GS} =0V, V _{DS} =50V, f=1MHz
Coss	-	29	44		
Crss	-	8	12		
Source-Drain Diode					
I _S *1	-	-	3.3	A	
I _{SM} *3	-	-	16		
V _{SD} *1	-	0.88	1.2	V	I _S =2A, V _{GS} =0V
trr	-	18.3	-	ns	I _F =2A, dI _F /dt=100A/μs
Qrr	-	9.8	-	nC	

Note : *1.Pulse Test : Pulse Width ≤300μs, Duty Cycle≤2%
 *2.Independent of operating temperature
 *3.Pulse width limited by maximum junction temperature.

Recommended soldering footprint

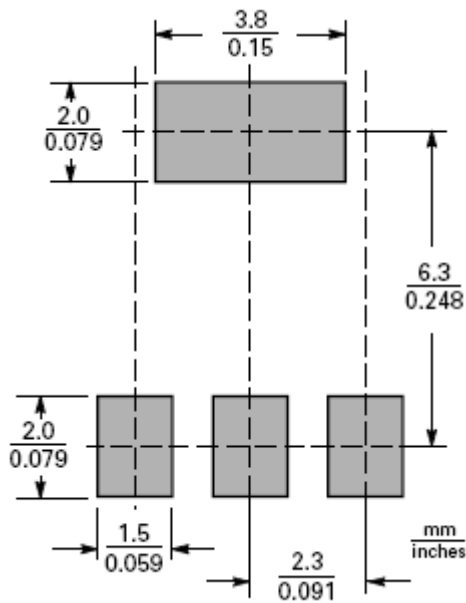



Typical Characteristics

Typical Output Characteristics

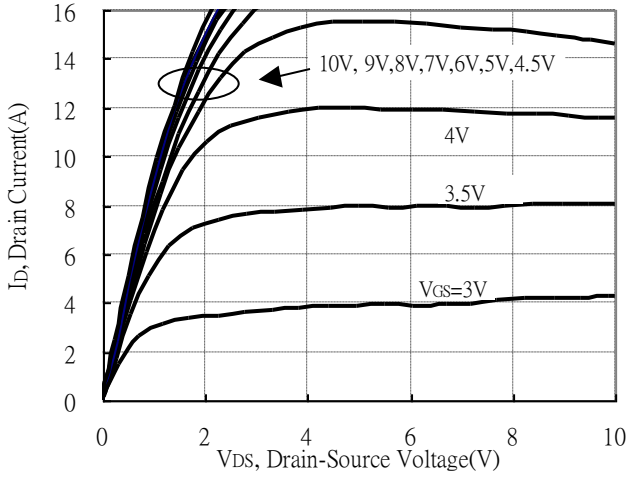

Brekdown Voltage vs Ambient Temperature

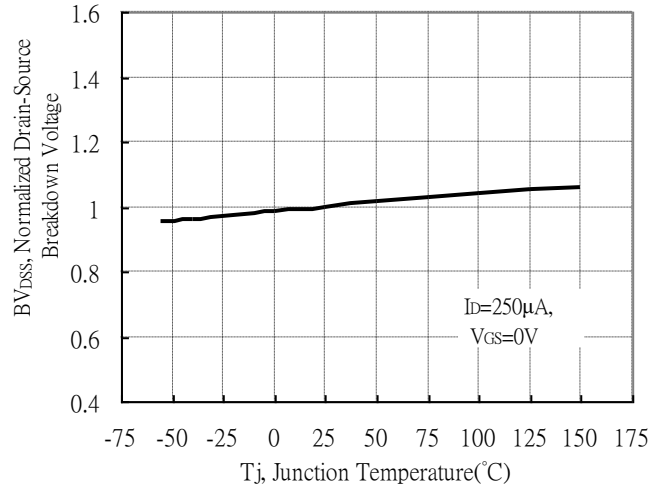

Static Drain-Source On-State resistance vs Drain Current

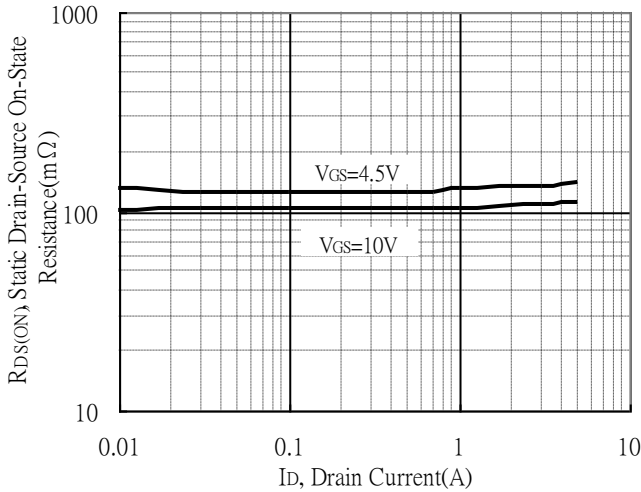

Reverse Drain Current vs Source-Drain Voltage

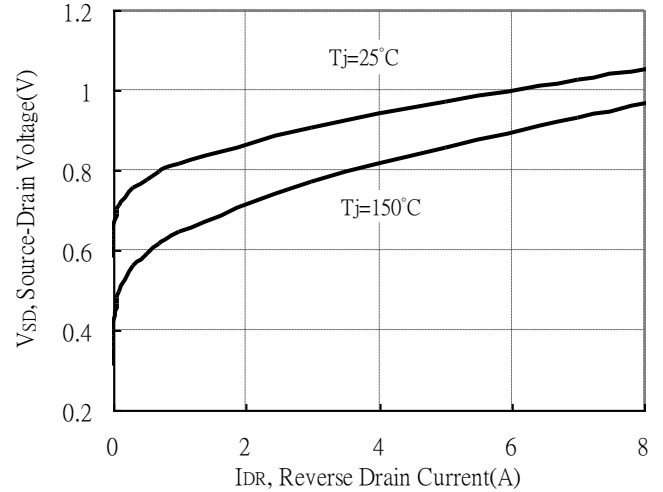

Static Drain-Source On-State Resistance vs Gate-Source Voltage

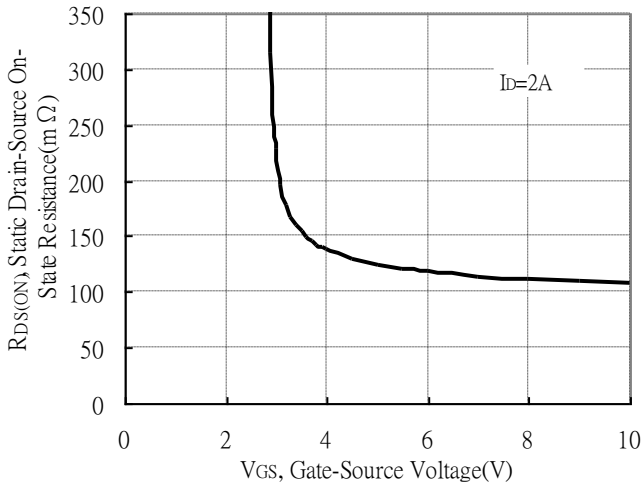

Drain-Source On-State Resistance vs Junction Temperature

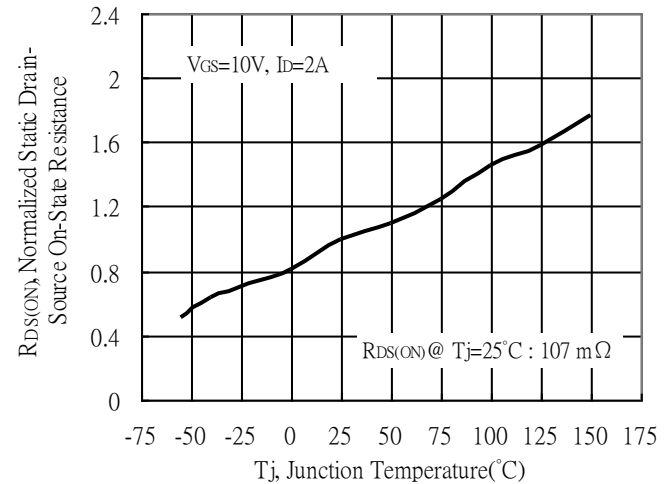

Typical Characteristics(Cont.)

Capacitance vs Drain-to-Source Voltage

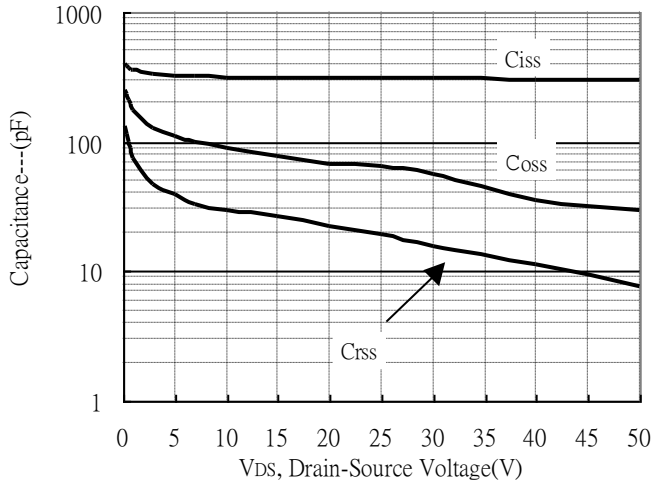

Threshold Voltage vs Junction Temperature

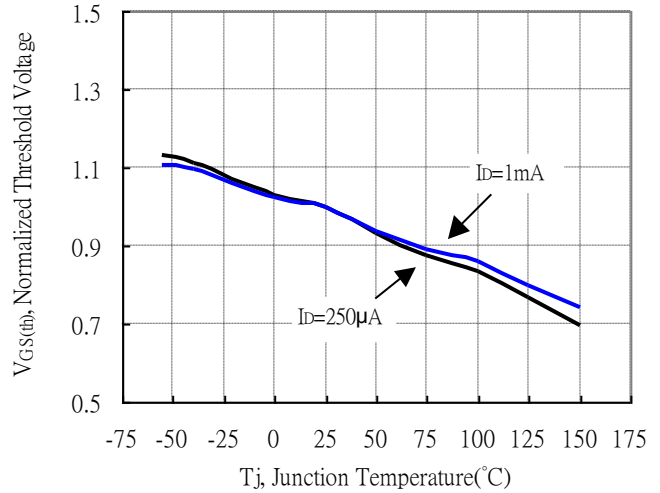

Forward Transfer Admittance vs Drain Current

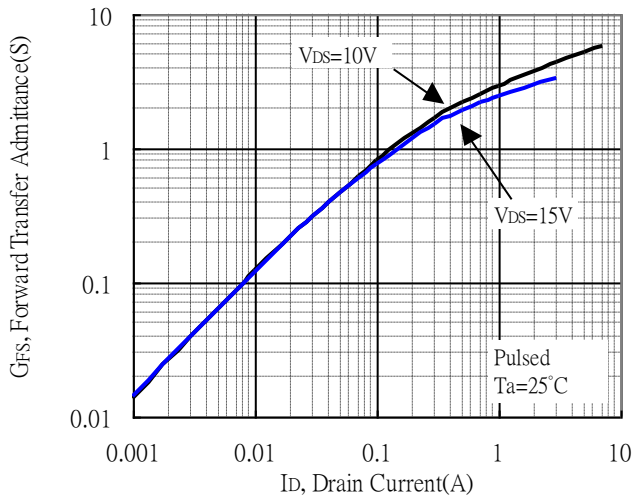

Gate Charge Characteristics

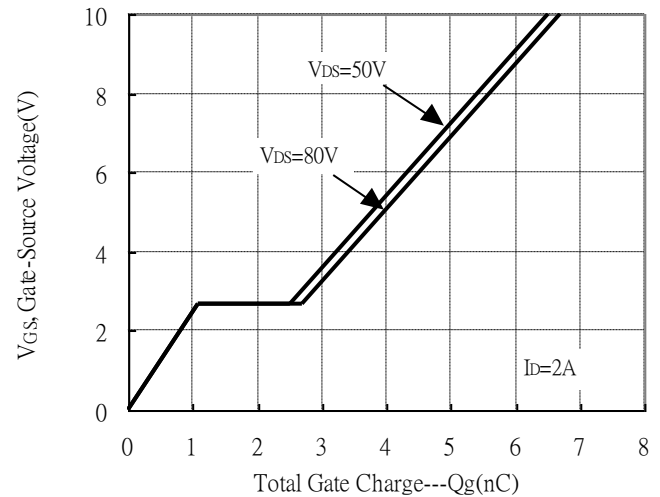

Maximum Safe Operating Area

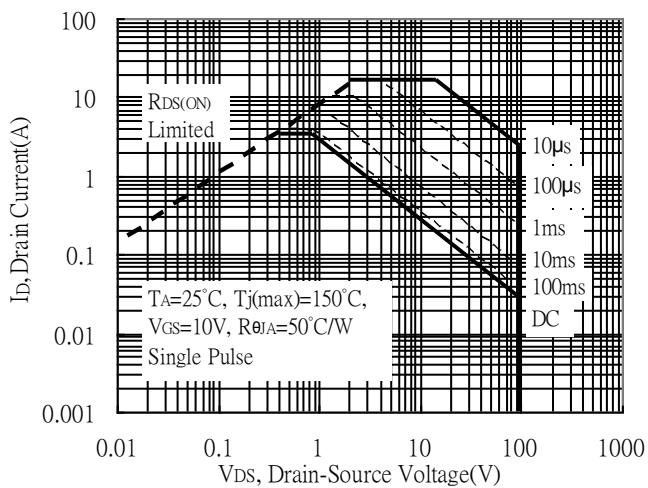

Maximum Drain Current vs Junction Temperature

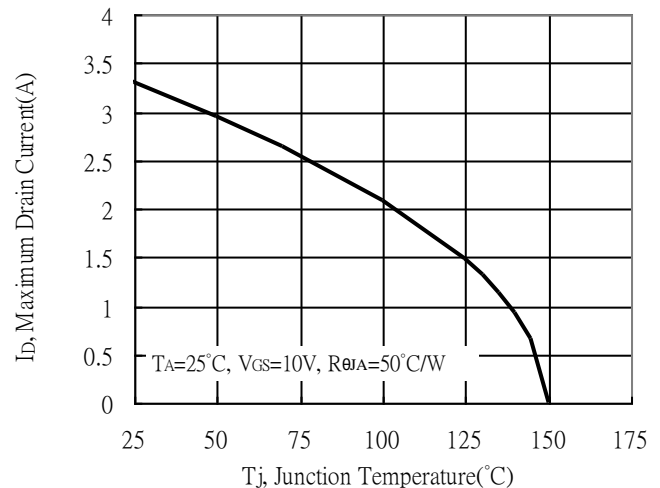



Typical Characteristics(Cont.)

Typical Transfer Characteristics

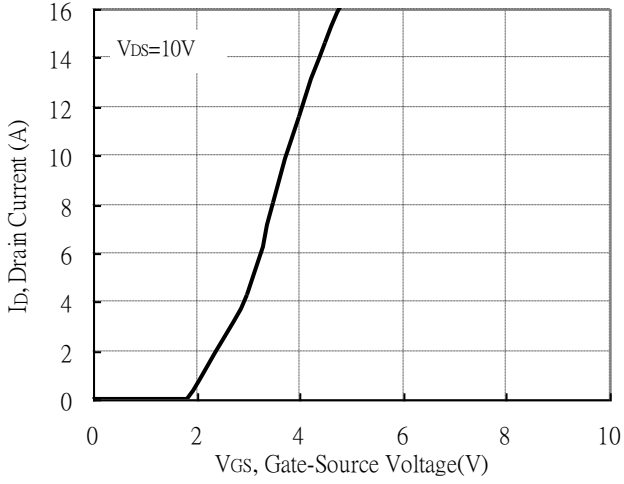

Single Pulse Maximum Power Dissipation

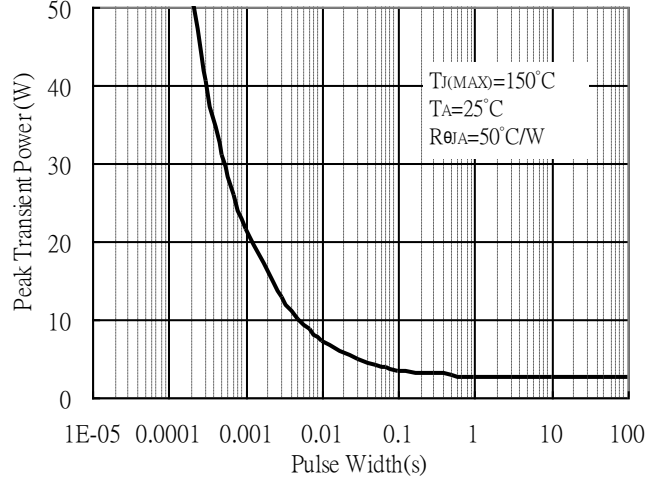

Transient Thermal Response Curves

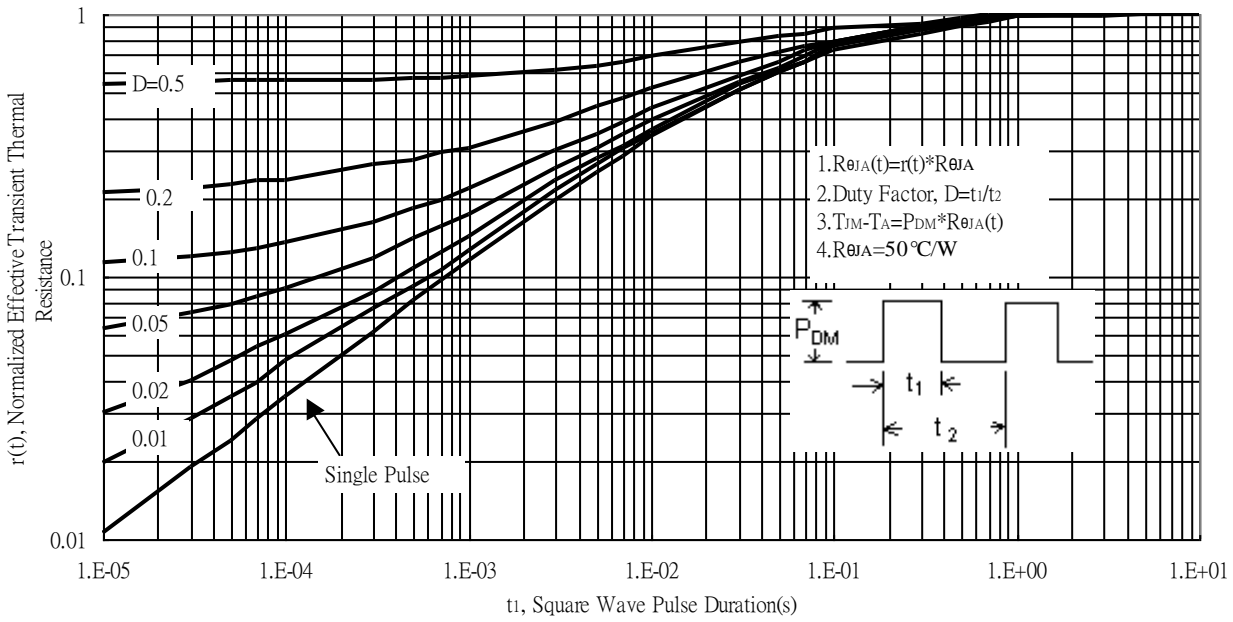

Reel Dimension

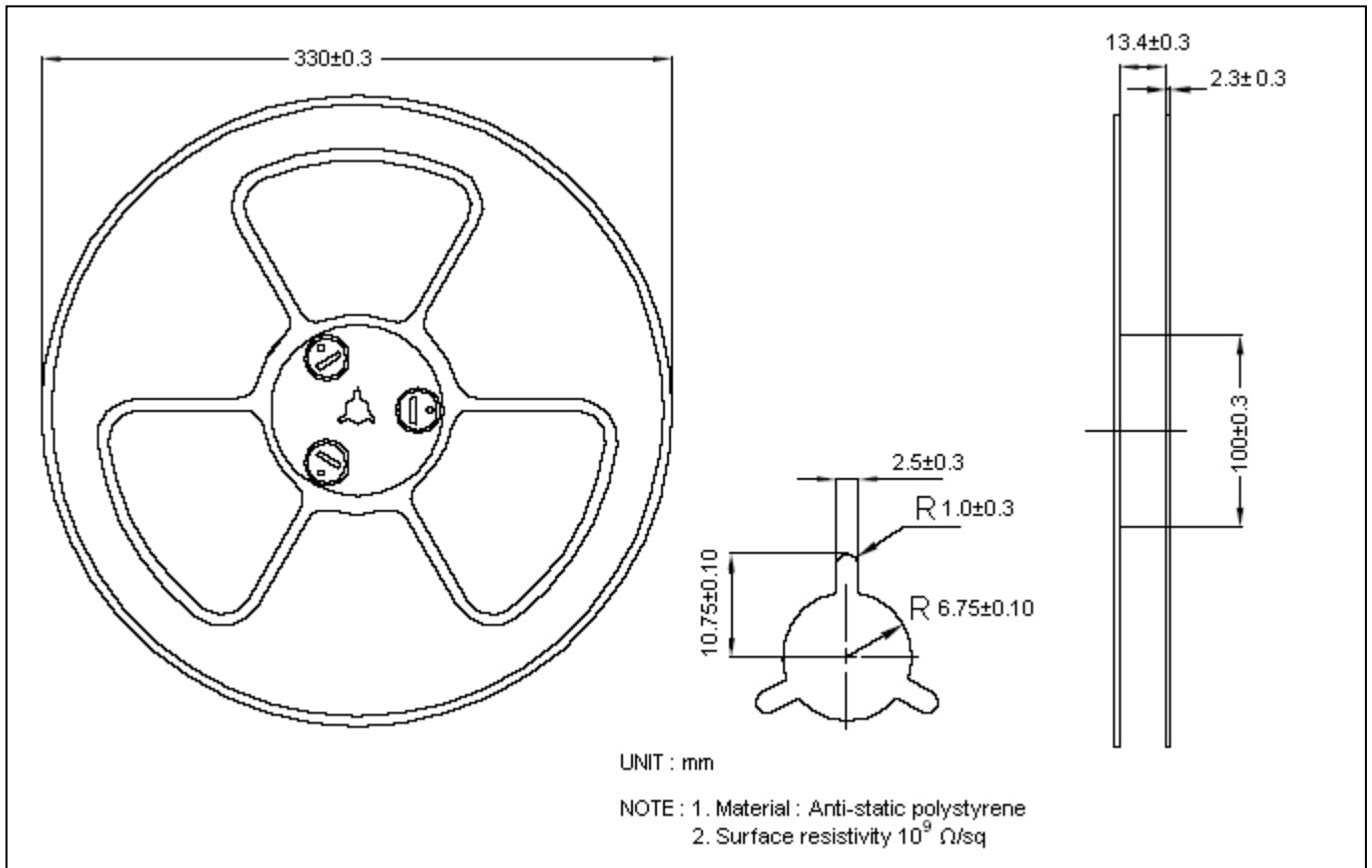

Carrier Tape Dimension

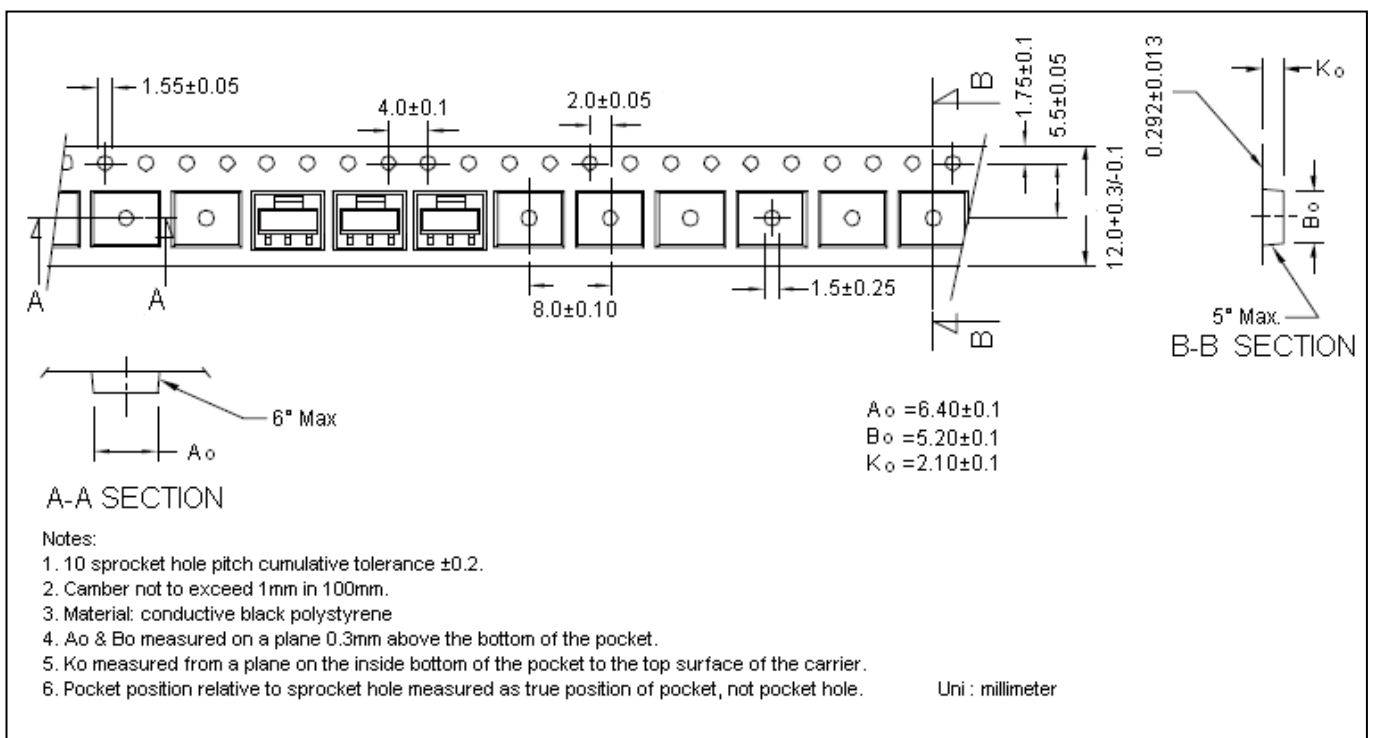

Recommended wave soldering condition

Product	Peak Temperature	Soldering Time
Pb-free devices	260 +0/-5 °C	5 +1/-1 seconds

Recommended temperature profile for IR reflow

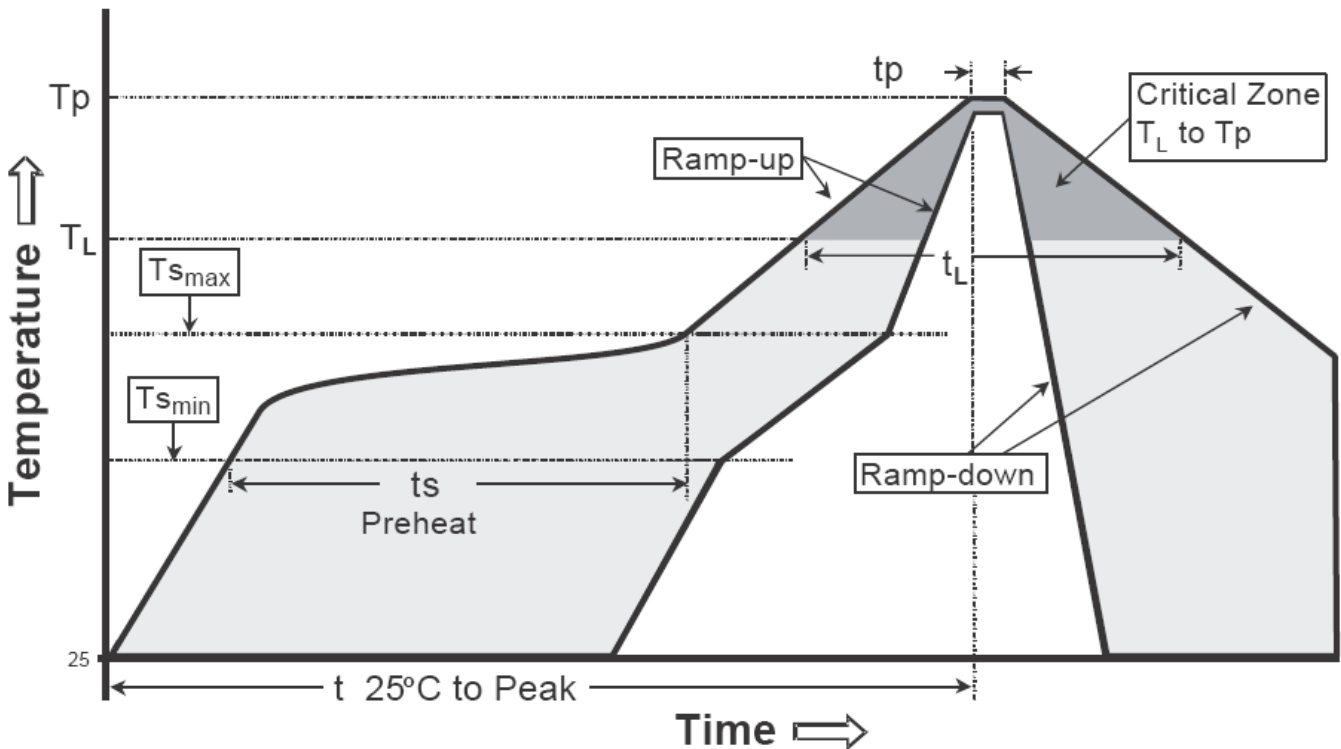

Profile feature	Sn-Pb eutectic Assembly	Pb-free Assembly
Average ramp-up rate (Tsmax to Tp)	3°C/second max.	3°C/second max.
Preheat		
-Temperature Min(Ts min)	100°C	150°C
-Temperature Max(Ts max)	150°C	200°C
-Time(ts min to ts max)	60-120 seconds	60-180 seconds
Time maintained above:		
-Temperature (Tl)	183°C	217°C
- Time (tl)	60-150 seconds	60-150 seconds
Peak Temperature(Tp)	240 +0/-5 °C	260 +0/-5 °C
Time within 5°C of actual peak temperature(tp)	10-30 seconds	20-40 seconds
Ramp down rate	6°C/second max.	6°C/second max.
Time 25 °C to peak temperature	6 minutes max.	8 minutes max.

Note :1. All temperatures refer to topside of the package, measured on the package body surface.
 2.For devices mounted on FR-4 PCB of 1.6mm or equivalent grade PCB. If other grade PCB is used, care should be taken to match the coefficients of thermal expansion between components and PCB. If they are not matched well, the solder joints may crack or the bodies of the parts may crack or shatter as the assembly cools.

SOT-223 Dimension

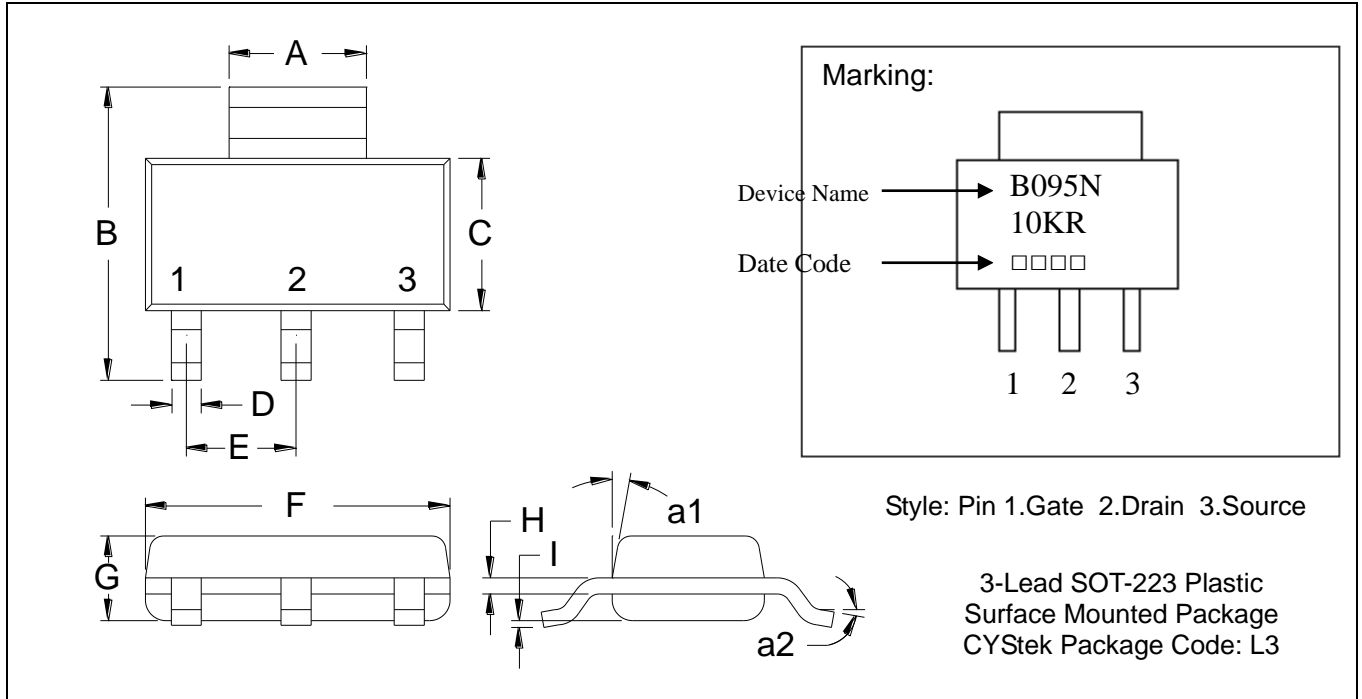

*: Typical

DIM	Inches		Millimeters		DIM	Inches		Millimeters	
	Min.	Max.	Min.	Max.		Min.	Max.	Min.	Max.
A	0.1142	0.1220	2.90	3.10	G	0.0551	0.0709	1.40	1.80
B	0.2638	0.2874	6.70	7.30	H	0.0098	0.0138	0.23	0.35
C	0.1299	0.1457	3.30	3.70	I	0.0008	0.0039	0.02	0.10
D	0.0236	0.0315	0.60	0.80	a1	*13°	-	*13°	-
E	*0.0906	-	*2.30	-	a2	0°	10°	0°	10°
F	0.2480	0.2638	6.30	6.70					

- Notes: 1.Controlling dimension: millimeters.
 2.Maximum lead thickness includes lead finish thickness, and minimum lead thickness is the minimum thickness of base material.
 3.If there is any question with packing specification or packing method, please contact your local CYStek sales office.

Material:

- Lead: Pure tin plated.
- Mold Compound: Epoxy resin family, flammability solid burning class: UL94V-0.

Important Notice:

- All rights are reserved. Reproduction in whole or in part is prohibited without the prior written approval of CYStek.
- CYStek reserves the right to make changes to its products without notice.
- CYStek **semiconductor products are not warranted to be suitable for use in Life-Support Applications, or systems.**
- CYStek assumes no liability for any consequence of customer product design, infringement of patents, or application assistance.