

Low Capacitance ESD TVS Array in SOT23-6

Features

- 80Watts peak pulse power ($t_p = 8/20\mu s$)
- SOT23-6 Package
- Unidirectional configurations
- Solid-state silicon-avalanche technology
- Low clamping voltage
- Low leakage current
- Low capacitance (0.2pF typical I/O to I/O)
- ESD Protection for high-speed data lines to:
 - IEC 61000-4-2 $\pm 15KV$ contact $\pm 15KV$ air
 - IEC 61000-4-4 (EFT) 40A (5/50ns)
 - IEC 61000-4-5 (Lightning) 6A (8/20 μs)

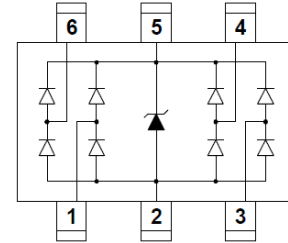
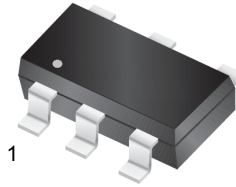

Mechanical Data

- **Case:** SOT23-6 (plastic package).
Lead free; RoHS compliant
- **Molding Compound Flammability Rating:**
UL 94 V-0
- **Terminals:** High temperature soldering guaranteed:
260 °C/10 sec. at terminals

Applications

- USB 3.0, USB 2.0, MHL
- HDMI 2.0, Display Port 1.3, eSATA
- Unified Display Interface (UDI)
- Digital Visual Interface (DVI)
- High speed serial interfaces

Absolute Maximum Ratings

Ratings at 25 °C, ambient temperature unless otherwise specified

Parameter	Symbol	Value	Unit
Peak Pulse Power ($T_P=8/20\mu S$)	P_{PP}	80	W
ESD contact/air discharge (IEC-61000-4-2)	V_{ESD}	15/15	kV
Peak Pulse Current ($t_P = 8/20\mu S$)	I_{PP}	6.0	A
Junction Temperature	T_J	-55 to +125	°C
Storage temperature	T_{STG}	-55 to +150	°C

Electrical Characteristics

($T_A = 25\text{ °C}$ unless otherwise specified)

Parameter	Symbol	Condition	Min	Typ	Max	Unit
Reverse stand-off Voltage	V_{RWM}				5	V
Reverse Breakdown Voltage	V_{BR}	$I_T=1mA$	6	6.8	8.5	V
Reverse Leakage Current	I_R	$V_R=5V$		0.01	1	μA
Clamping Voltage(SURGE)	V_C	$I_{PP}=6A, T_P=8/20\mu S$		14	16	V
Trigger Voltage(ESD)	V_T	$V_{ESD} = +8kV$		90		V
Clamping Voltage(ESD)	V_C	$V_{ESD} = +8kV$		15		V
Junction Capacitance	C_J	$V_R=0V, f=1MHz, I/O$ to I/O		0.2	0.4	pF
	C_J	$V_R=0V, f=1MHz, I/O$ to GND		0.4	0.8	pF

Typical Characteristics ($T_{amb} = 25\text{ }^{\circ}\text{C}$ unless otherwise specified)

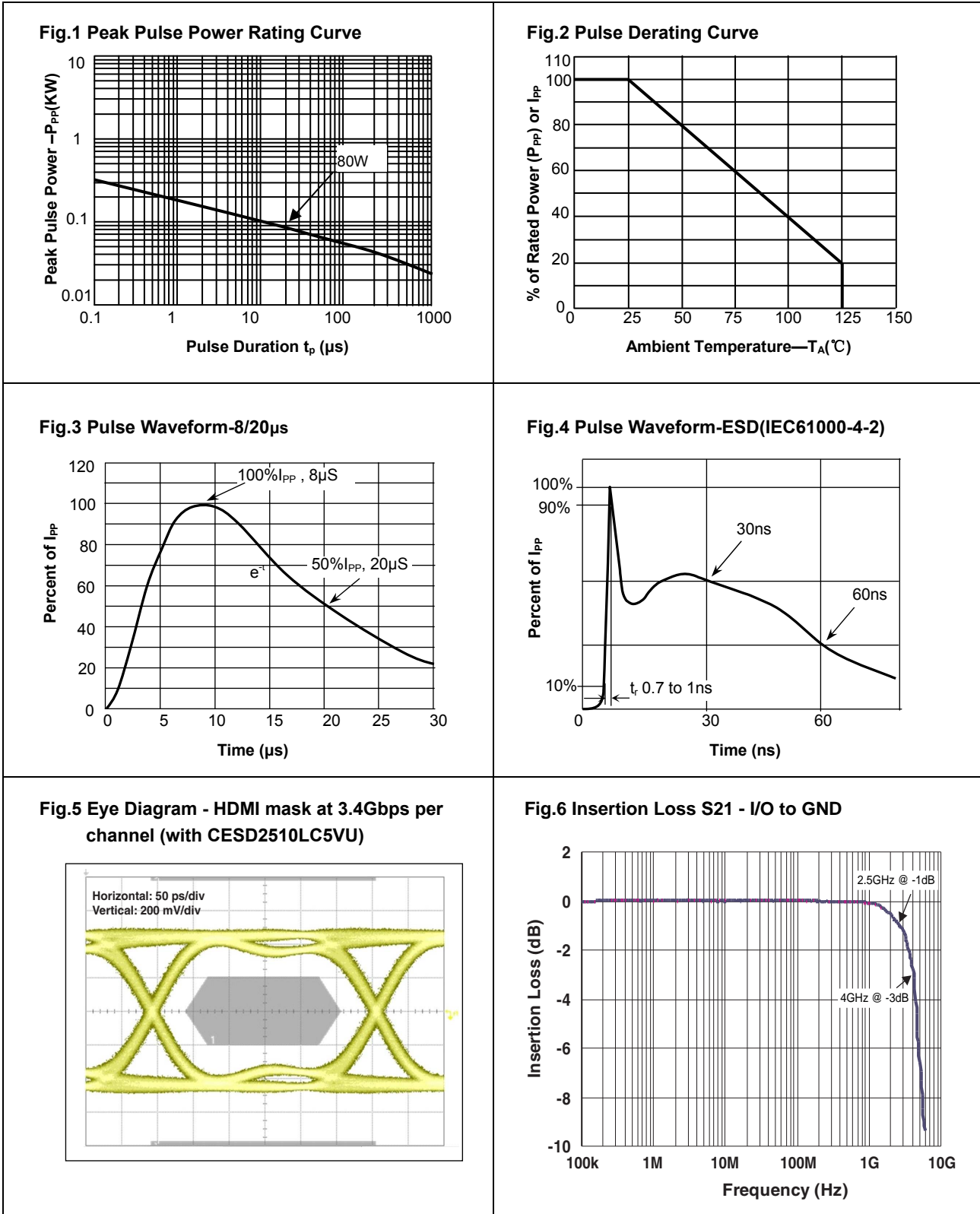

Package Dimensions

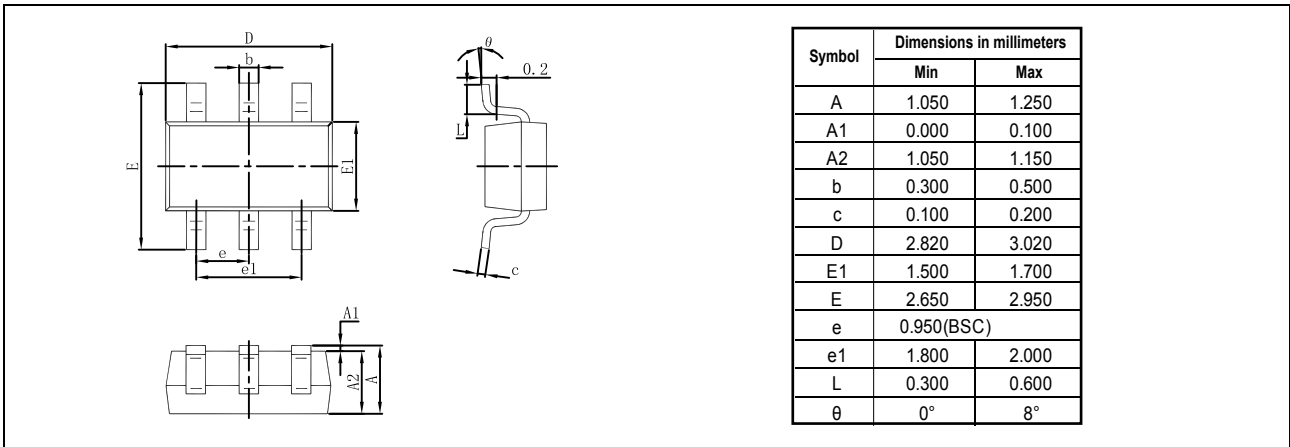

Part number system

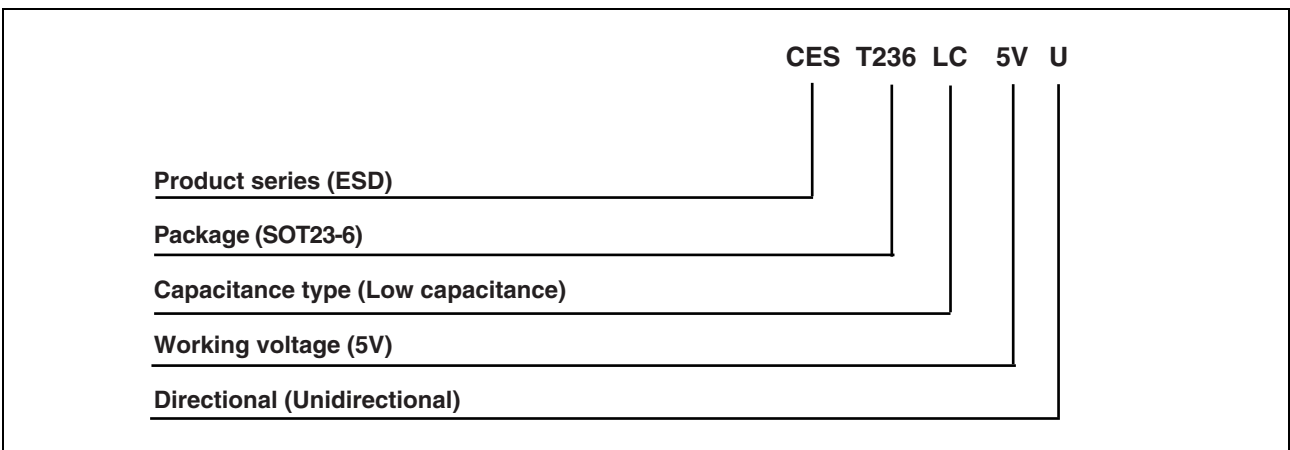

Marking

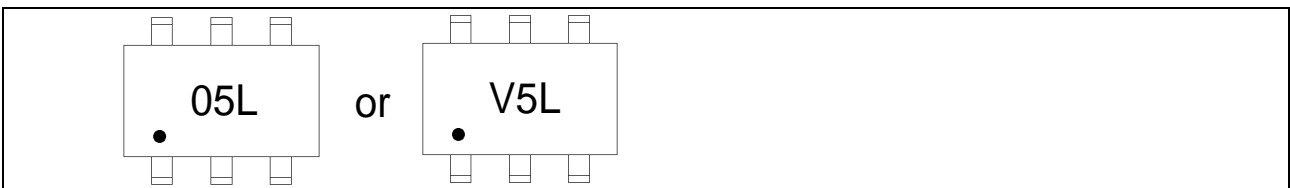

Ordering information

Order code	Package	Packaging option	Base quantity	Packaging specification
CEST236LC5VU	SOT23-6	Tape and reel	3000pcs / reel	EIA STD RS-481

Revision history

Date	Revision	Changes
23-May-2012	1.0	Initial release
28-Oct.-2016	2.0	update marking

CAUTION / WARNING

Information in this document is believed to be accurate and reliable. However, CREATEK does not give any representations or warranties, expressed or implied, as to the accuracy or completeness of such information and shall have no liability for the consequences of use of such information.

Users should independently evaluate the suitability of and test each product selected for their own applications, and CREATEK assumes no liability whatsoever relating to the choice, selection or use of the CREATEK products and services described herein.

CREATEK reserves the right to change or update, without notice, any information contained in this publication; to change, without notice, the design, construction, processing, or specification of any product; and to discontinue or limit production or distribution of any product.

Information in this document supersedes and replaces all information previously supplied.

Products are not designed, authorized or warranted to be suitable for use in medical, military, aircraft, space or life support equipment, nor in applications where failure or malfunction of an CREATEK product can reasonably be expected to result in personal injury, death or severe property or environmental damage. CREATEK accepts no liability for inclusion and/or use of CREATEK products in such equipment or applications and therefore such inclusion and/or use is at the customer's own risk.

This document as well as the item(s) described herein may be subject to export control regulations. Export might require a prior authorization from national authorities.

Resale of CREATEK products with provisions different from the statements and/or technical features set forth in this document shall immediately void any warranty granted by CREATEK for the CREATEK product or service described herein and shall not create or extend in any manner whatsoever, any liability of CREATEK.

CREATEK expressly disclaims all implied warranties regarding the information contained herein, including, but not limited to, any implied warranties of merchantability or fitness for a particular purpose. CREATEK only obligations are those in the CREATEK Standard Terms and Conditions of Sale and in no case will CREATEK be liable for any incidental, indirect, or consequential damages arising from the sale, resale, use, or misuse of its products.

Specifications are subject to change without notice

© Copyright 2009, CREATEK Microelectronics

 CREATEK® is a registered trademark of CREATEK Microelectronics

All rights reserved