

	Cosemitech	CH941
	Automotive Product Group	<small>This is advanced information on a new product now in development or undergoing evaluation. Details are subject to change without notice and Cosemitech assumes no obligation for future manufacture of this product. Contact Cosemitech for the latest status.</small>

REV 1.0

FEATURES and FUNCTIONAL DIAGRAM

- Unipolar respond to a single pole: North (CH941S) or South (CH941T and CH941E), making these products well-suited for shift selectors, wiper end/home position, door ajar/open, and vane-interrupt systems etc.
- Enhanced sensitivity: will operate from Brp 110 Gauss to Bop 150 Gauss typical with very good temperature-stable and stress-resistant, allowing the use of smaller, potentially lower-cost magnets or high robust application
- Subminiature, SOT-23-3L(CH941S) or SOT-89-3L(CH941E) surface mount package supplied on tape and reel allows for a compact design with automated component placement, helping to reduce manufacturing costs
- Small, leaded, flat, TO-92S package (CH941T) allows for a compact PCB layout
- Wide operating voltage range of 3.3V to 30V makes these sensors useable in a wide range of applications
- Built-in reverse voltage capability enhances the protection of the sensor and the circuits with which it is used
- Robust design: will operate up to 150 °C
- RoHS-compliant material meets directive 2002/95

Function Block Diagram

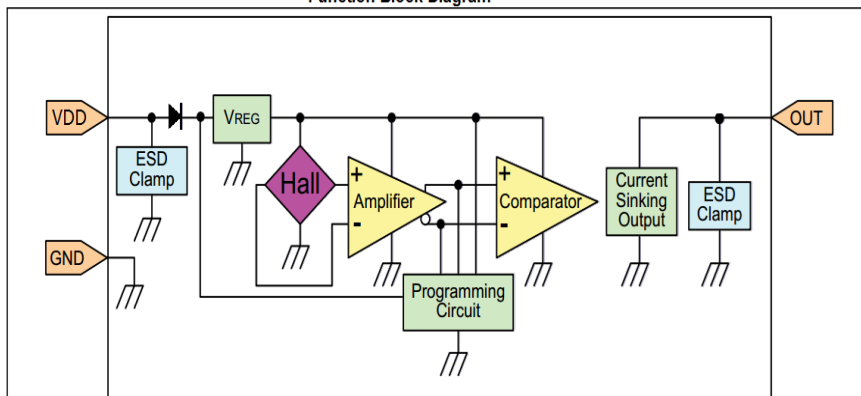

PACKAGE

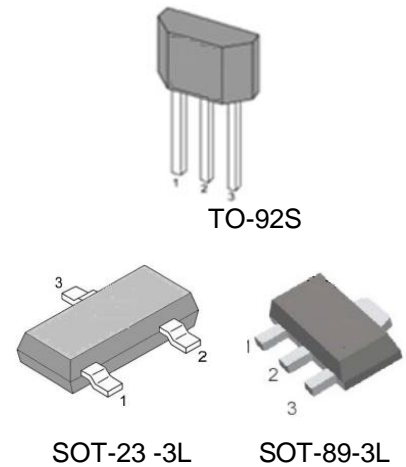

APPLICATIONS

Commercial:

- Door or lid closure detection in appliances
- Speed and RPM sensing in fitness equipment
- Flow rate sensing in appliances and water softeners
- Damper or valve position control in HVAC equipment
- Printer head position sensing

Industrial

- Flow rate sensing in industrial processes
- Robotic control (cylinder position monitoring)
- Float-based fluid level sensing

Medical

- Displacement sensor in hospital beds and medical equipment
- Medication bin monitor on portable drug carts

DESCRIPTION

The CH941S, CH941E and CH941T are small, versatile digital Hall-effect devices that are operated by the magnetic field from a permanent magnet or an electromagnet.

This unipolar sensors are designed to meet the requirements of a wide range of potential applications. These economical unipolar sensors are well suited for simple, high-volume, cost-sensitive position and motion sensing applications.

The 3.3Vdc to 30 Vdc supply voltage range allows this device to be used in very wide voltage applications.

These sensors are available in two package styles: the CH941S in the subminiature SOT-23-3L surface mount package, the CH941E in the subminiature SOT-89-3L surface mount package, the CH941T is available in the leaded, flat TO-92-style package.

The CH941S and CH941E are available on tape and reel (CH941S 3000 units per reel, CH941E 1000 units per reel), the CH941T is available in a bulk package (1000 units per bag).

	Cosemitech	CH941
	Automotive Product Group	<small>This is advanced information on a new product now in development or undergoing evaluation. Details are subject to change without notice and Cosemitech assumes no obligation for future manufacture of this product. Contact Cosemitech for the latest status.</small>

REV 1.0

Table of Contents

1. Product Family Members.....		3
2. Pin Definitions and Descriptions.....		3
3. Absolute Maximum Ratings.....		3
4. ESD Protections.....		4
5. Function Description.....		4
6. Definition of Switching Function.....		4
7. Temperature Characterization.....		4
8. Parameters Specification.....		5
9. Test Conditions.....		6
10. Typical Application Circuit.....		6
11. Typical Output Waveform.....		6
12. Package Information.....		7

	Cosemitech	CH941
	Automotive Product Group	<small>This is advanced information on a new product now in development or undergoing evaluation. Details are subject to change without notice and Cosemitech assumes no obligation for future manufacture of this product. Contact Cosemitech for the latest status.</small>

REV 1.0

1. Product Family Members

Part Number	Marking ID	Description
CH941SR	C941	Uni-polar, Open Collector Output, Hall-effect digital sensor IC, SOT-23-3L package, tape and reel packing (3000 units per reel)
CH941TB	C941	Uni-polar, Open Collector Output, Hall-effect digital sensor IC, flat, TO-92S package, bulk packing (1000 units per bag)
CH941ER	C941	Uni-polar, Open Collector Output, Hall-effect digital sensor IC, SOT-89-3L package, tape and reel packing (1000 units per reel)

2. Pin Definitions and Descriptions

SOT-23-3L(S)	TO-92S(T)	Name	Type	Function
1	1	VDD	Supply	Supply Voltage pin
2	3	OUT	Output	Open Collector Output pin
3	2	GND	Ground	Ground pin

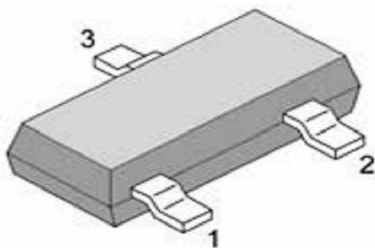

SOT-23-3L

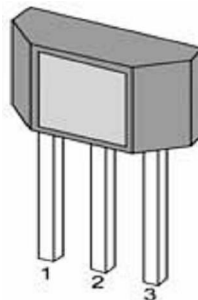

TO-92S

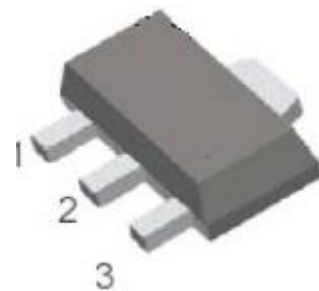

SOT-89-3L

3. Absolute Maximum Ratings

Parameter	Symbol	Min	Max	Units
Supply Voltage	V_{DD}	-	40	V
Reverse Voltage	V_{RDD}	-	-40	V
Supply Current	I_{DD}	-	20	mA
Output Voltage	V_{OUT}	-	40	V
Output Current	I_{OUT}	-	20	mA
Operating Ambient Temperature	T_A	-40	150	°C
Storage Temperature	T_S	-50	150	°C
Junction temperature	T_J	-50	165	°C
Magnetic Flux	B	No Limit		Gauss

Note: Exceeding the absolute maximum ratings may cause permanent damage. Exposure to absolute-maximum-rated conditions for extended periods may affect device reliability.

	Cosemitech	CH941
	Automotive Product Group	<small>This is advanced information on a new product now in development or undergoing evaluation. Details are subject to change without notice and Cosemitech assumes no obligation for future manufacture of this product. Contact Cosemitech for the latest status.</small>

REV 1.0

4. ESD Protections

Parameter	Value	Unit
All pins ¹⁾	+/-2000	V
All pins ²⁾	+/-200	V
All pins ³⁾	+/-750	V

- 1) HBM (human body mode, 100pF, 1.5 kohm) according to MIL-STD-883H Method 3015.8
2) MM (Machine Mode C=200pF, R=0 Ω) according to JEDEC EIA/JESD22-A115
3) CDM (charged device mode) according to JEDEC EIA/JESD22-C101F

5. Function Description

The CH941S/CH941T/CH941E exhibits unipolar magnetic switching characteristics. Therefore, it requires south or north poles to operate properly.

The device behaves as a unipolar with asymmetric operating and release switching points. This means While the magnetic flux density(B) is larger than operate point (Bop), the output will be turned on (Low), while the magnetic flux density(B) is lower than release point (Brp), then turn off (High).

6. Magnetic Activation

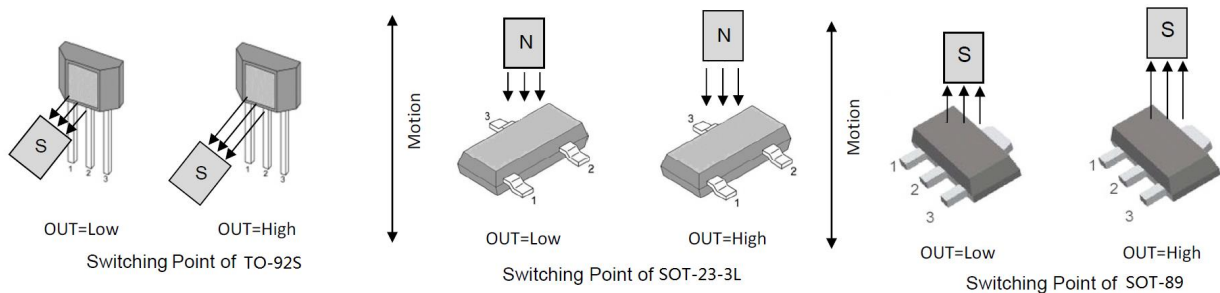

7. Temperature Characteristics

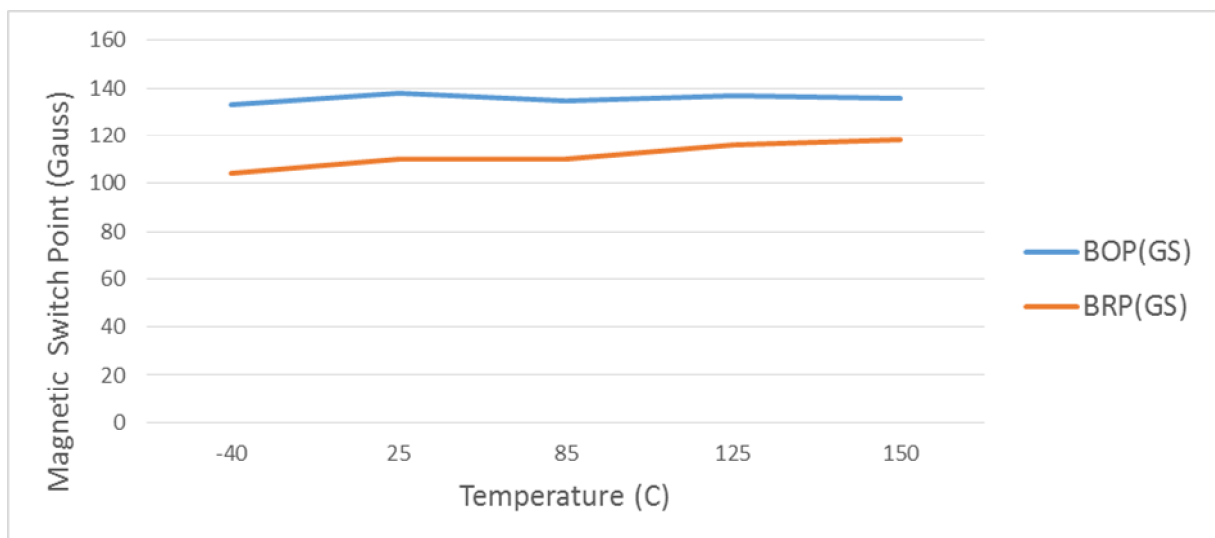

**8. Parameters Specification (At 3.3V to 30V supply, 20mA load, TA= -40 °C to 150 °C except where otherwise specified.)**

Symbol	Parameter	Test Condition	Min	Typ.	Max	Units
V _{DD}	Supply voltage	-40 °C to 150 °C	3.3	-	30	V
I _{DD}	Supply Current	V _{DD} = 5V	-	3.5	8	mA
V _{DSon}	Output saturation voltage	at 20mA, Gauss >200	-	-	0.4	V
I _{OFF}	Output Leakage Current	B<50GS	-	-	10	uA
T _R	Output rise time	V _{DD} =12V at 25 °C C _L = 20 pF	-	-	1.5	uS
T _F	Output fall time	V _{DD} =12V at 25 °C C _L = 20 pF	-	-	1.5	uS
R _{TH}	Thermal resistance: CH941S (SOT-23-3L) CH941T (TO-92S) CH941E(SOT-89-3L)	-	-	303 203 230	-	°C /W °C/W °C/W
B _{OP}	Magnetic operating point	TA=25°C	100	140	190	Gauss
B _{RP}	Magnetic release point	TA=25°C	70	110	140	Gauss
B _{HYST}	Magnetic hysteresis window	T _A =25°C B _{OP} -B _{RP}	20	30	60	Gauss
F _{SW}	Maximum Switching Frequency				100	KHz
T	Operating temperature		-40	-	150	°C
T _S	Storage temperature:	-	-40	-	150	°C

NOTICE

Bipolar Hall-effect sensor ICs may have an initial output in either the ON or OFF state if powered up with an applied magnetic field in the differential zone (applied magnetic field >Brp and <Bop). Cosemitech recommends allowing 10 μs for output voltage to stabilize after supply voltage has reached 5V.

NOTICE

The magnetic field strength (Gauss) required to cause the switch to change state (operate and release) will be as specified in the magnetic characteristics. To test the switch against the specified magnetic characteristics, the switch must be placed in a uniform magnetic field.

9. Test Conditions

Note: DUT=Device Under Test

Supply Current

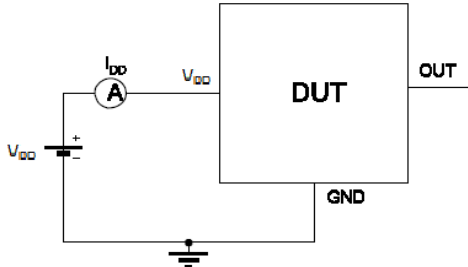

Note 1 - The supply current I_{DD} represents the static supply current. OUT is left open during measurement

Note 2 - The device is put under magnetic field with $B < B_{RP}$

Output Saturation Voltage

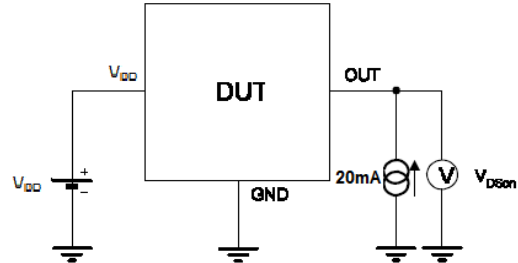

Note 1 - The output saturation voltage V_{DSon} is measured at $V_{DD}=3.8V$ and $V_{DD}=24V$

Note 2 - The device is put under magnetic field with $B > B_{OP}$

Output Leakage Current

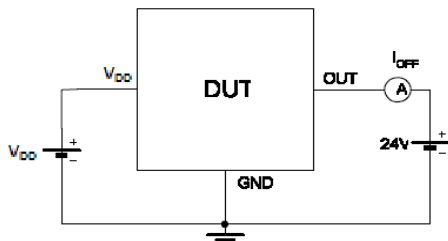

Note 1 - The device is put under magnetic field with $B < B_{RP}$

Magenetic Thresholds

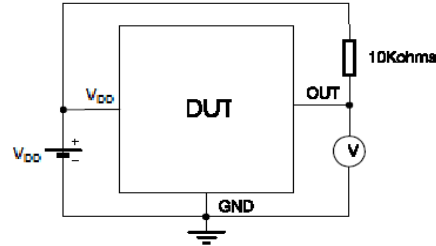

Note 1 - B_{OP} is determined by putting the device under magnetic field swept from B_{RPmin} up to B_{OPmax} until the output is switched on.

Note 2 - B_{RP} is determined by putting the device under magnetic field swept from B_{OPmax} down to B_{RPmin} until the output is switched off.

10. Typical Application Circuit

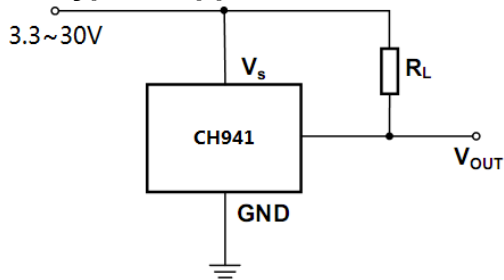

11. Typical Output Waveform (The TO-92S package as an example)

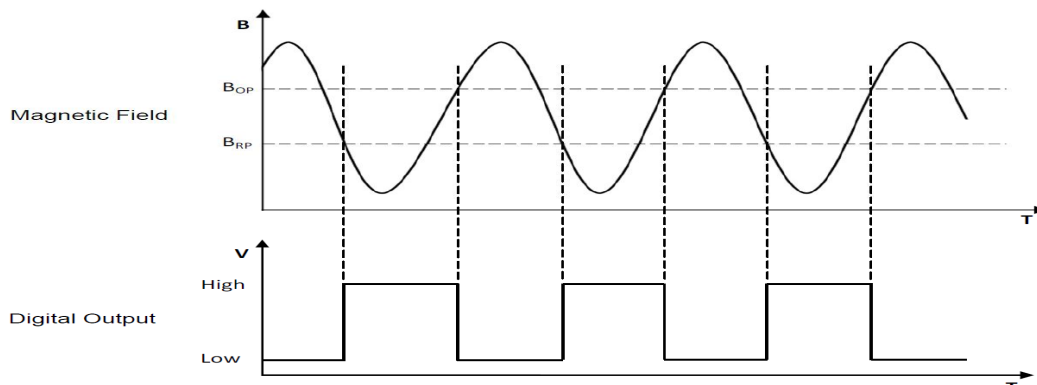

12. Package Information:

**PACKAGE DESIGNATOR
TO-92S**

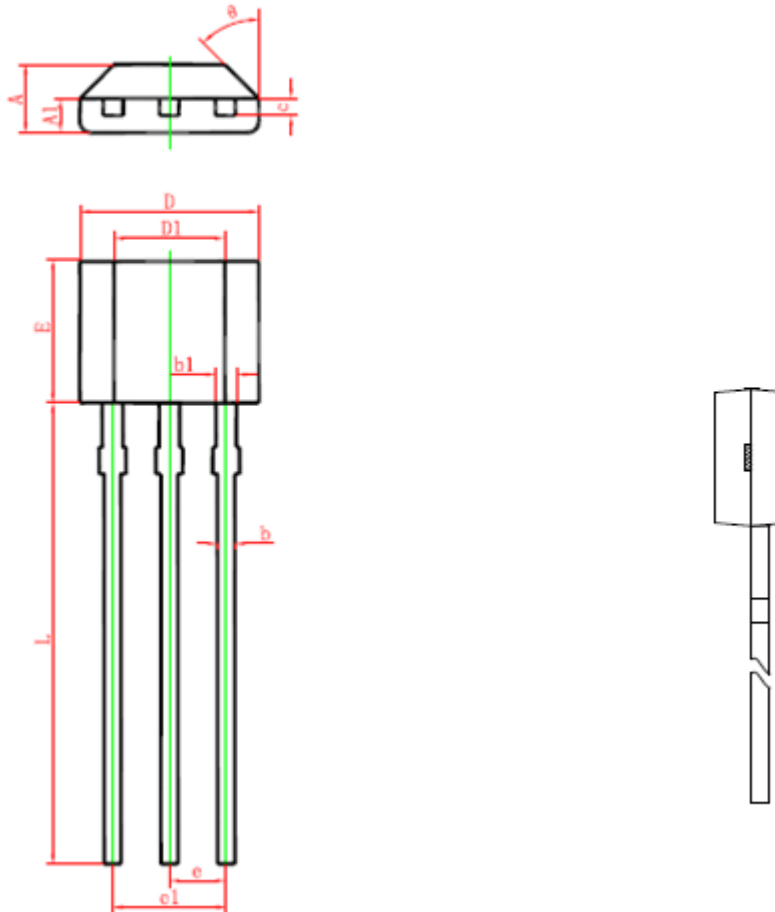

Symbol	Dimensions In Millimeters		Dimensions In Inches	
	Min.	Max.	Min.	Max.
A	1.420	1.620	0.056	0.064
A1	0.660	0.860	0.026	0.034
b	0.350	0.480	0.014	0.019
b1	0.400	0.550	0.016	0.022
c	0.360	0.510	0.014	0.020
D	3.900	4.100	0.154	0.161
D1	2.280	2.680	0.090	0.106
E	3.050	3.250	0.120	0.128
e	1.270 TYP.		0.050 TYP.	
e1	2.440	2.640	0.096	0.104
L	15.100	15.500	0.594	0.610
θ	45° TYP.		45° TYP.	

PACKAGE DESIGNATOR
SOT-23-3L

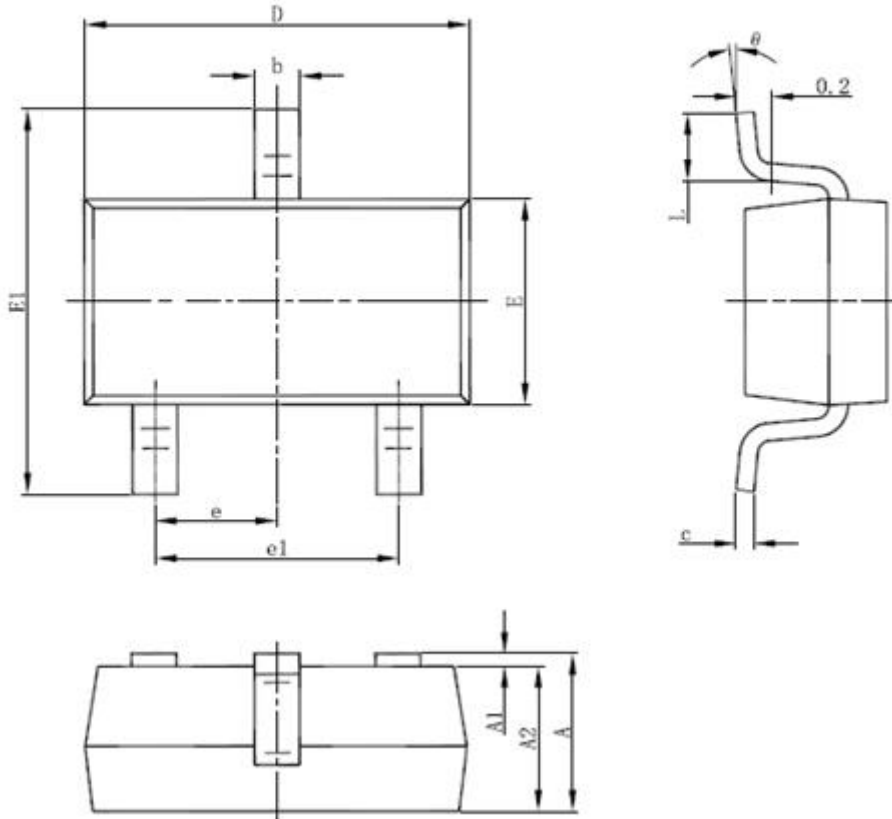

Symbol	Dimensions In Millimeters		Dimensions In Inches	
	Min	Max	Min	Max
A	1.050	1.250	0.041	0.049
A1	0.000	0.100	0.000	0.004
A2	1.050	1.150	0.041	0.045
b	0.300	0.500	0.012	0.020
c	0.100	0.200	0.004	0.008
D	2.820	3.020	0.111	0.119
E	1.500	1.700	0.059	0.067
E1	2.650	2.950	0.104	0.116
e	0.950(BSC)		0.037(BSC)	
e1	1.800	2.000	0.071	0.079
L	0.300	0.600	0.012	0.024
θ	0°	8°	0°	8°

**PACKAGE DESIGNATOR
SOT-89-3L**

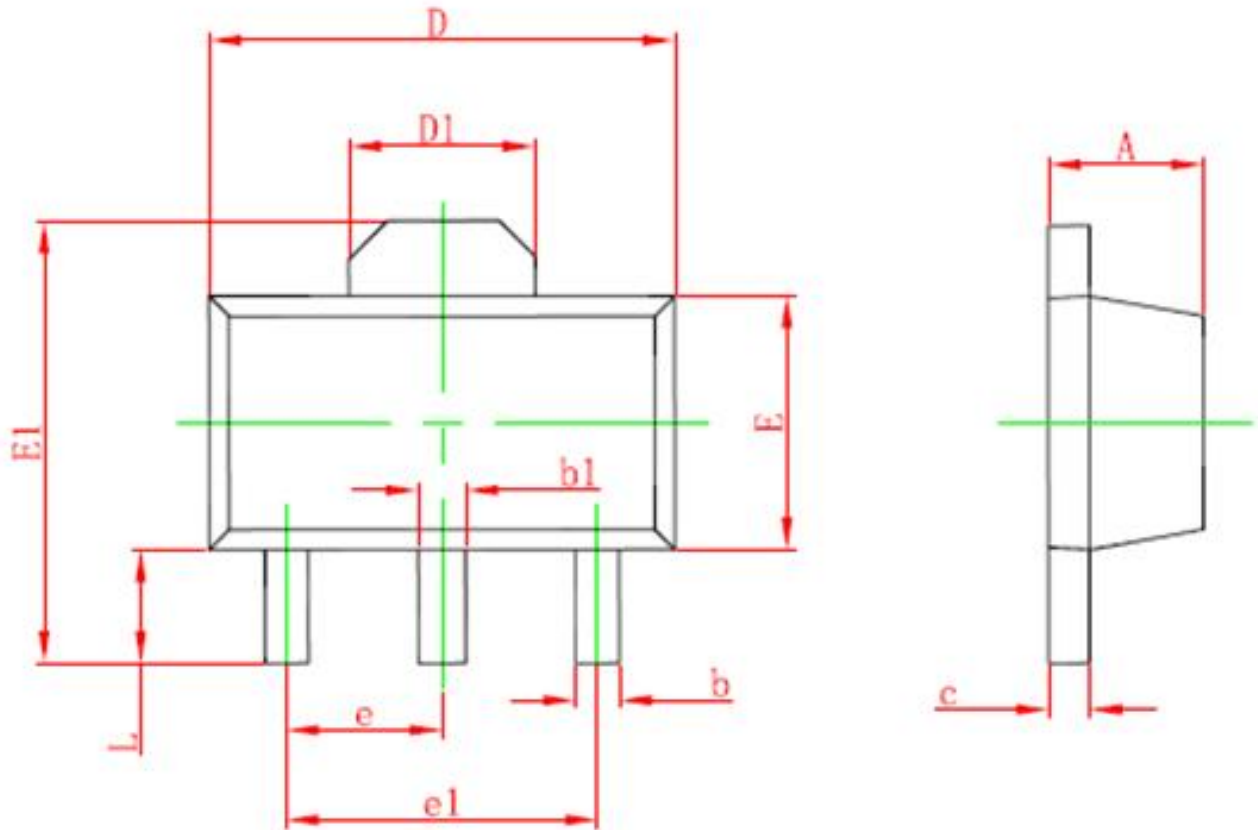

Symbol	Dimensions In Millimeters		Dimensions In Inches	
	Min.	Max.	Min.	Max.
A	1.400	1.600	0.055	0.063
b	0.320	0.520	0.013	0.020
b1	0.400	0.580	0.016	0.023
c	0.350	0.440	0.014	0.017
D	4.400	4.600	0.173	0.181
D1	1.550 REF.		0.061 REF.	
E	2.300	2.600	0.091	0.102
E1	3.940	4.250	0.155	0.167
e	1.500 TYP.		0.060 TYP.	
e1	3.000 TYP.		0.118 TYP.	
L	0.900	1.200	0.035	0.047

	Cosemitech	CH941
	Automotive Product Group	<small>This is advanced information on a new product now in development or undergoing evaluation. Details are subject to change without notice and Cosemitech assumes no obligation for future manufacture of this product. Contact Cosemitech for the latest status.</small>

REV 1.0

Information furnished is believed to be accurate and reliable. However, Cosemitech assumes no responsibility for the consequences of use of such information nor for any infringement of patents or other rights of third parties which may result from its use. No license is granted by implication or otherwise under any patent or patent rights of Cosemi-tech. Specification mentioned in this publication are subject to change without notice. This publication supersedes and replaces all information previously supplied. Cosemitech products are not authorized for use as critical components in life support devices or systems without express written approval of Cosemitech.

The Cosemitech logo is a registered trademark of Cosemitech