

## 300mA High PSRR, Linear Regulator, w. Output Discharge

### DESCRIPTION

BL8563 series is a group of positive voltage output, low power consumption, low dropout voltage regulator.

BL8563 can provide output value in the range of 1.0V~4.5V every 0.1V step. It also can be customized on command. BL8563 can also work under a wide input voltage ranging from 2.0V to 6V.

BL8563 includes high accuracy voltage reference, error amplifier, current limit circuit and output driver module.

BL8563 has excellent load and line transient response and good temperature characteristics, which can assure the stability of chip and power system. And it uses trimming technique to guarantee output voltage accuracy within  $\pm 2\%$ .

BL8563 is available in SOT-23-3, SOT-23-5, SC-70-5, DFN1x1-4 and DFN1.2x1.6-4 packages which is lead free.

### TYPICAL APPLICATION

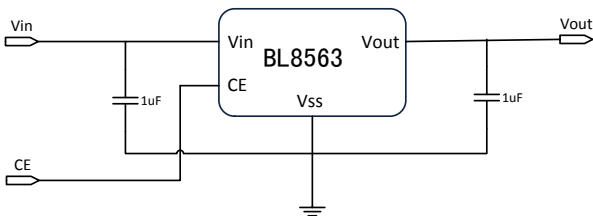

**NOTE:** Input capacitor ( $C_{in}=1\mu F$ ) and Output capacitor ( $C_{out}=1\mu F$ ) are recommended in all application circuit.

### FEATURES

- Output voltage range: 1.0V~4.5V (customized on command every 0.1V step)
- Low power consumption: 35uA (Typ.)
- Low output noise (47uVRMS)
- Shutdown mode: 0.1uA
- Low dropout voltage: 300mV@300mA (Typ.)
- High ripple rejection: 70dB@1KHz (Typ.)
- Low temperature coefficient:  $\pm 100\text{ppm}/^\circ\text{C}$
- Excellent line regulation: 0.05%/V
- Build-in 1.5K discharge resistor when CE low
- Highly accurate:  $\pm 2\%$
- Output current limit
- Fold-back output short circuit protection

### APPLICATIONS

- Power source for cellular phones and various kind of PCSs
- Battery Powered equipment
- Power Management of MP3, PDA, DSC, Mouse, PS2 Games
- Voltage Reference
- Regulation after Switching Power

### ELECTRICAL CHARACTERISTICS

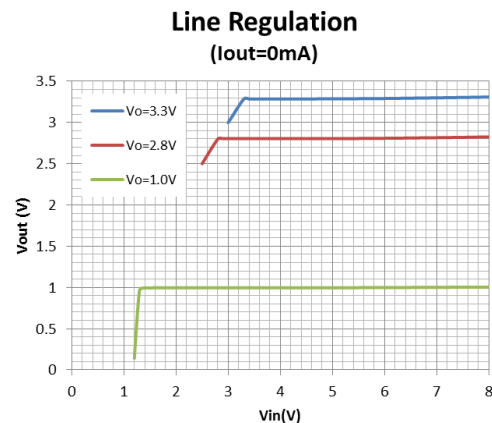

## ORDERING INFORMATION

BL8563- 1 2 3

Code	Description
<span style="border: 1px solid black; padding: 0 2px;">1</span>	Output voltage: e.g. 10=1.0V 18=1.8V 45=4.5V
<span style="border: 1px solid black; padding: 0 2px;">2</span>	Temperature&Rohs: P:-40~85°C ,Pb Free Rohs Std.
<span style="border: 1px solid black; padding: 0 2px;">3</span>	Package type: RA: SOT-23-5(A) Q: SC-70-5 RM: SOT-23-3

**NOTE:** For DFN Package

BL8563 1 2 3 4

Code	Description
<span style="border: 1px solid black; padding: 0 2px;">1</span>	Temperature&Rohs: C:-40~85°C ,Pb Free Rohs Std.
<span style="border: 1px solid black; padding: 0 2px;">2</span>	Package type: KE:DFN1x1-4 KF:DFN1.2x1.6-4
<span style="border: 1px solid black; padding: 0 2px;">3</span>	Packing type: TR:Tape&Reel (Standard)
<span style="border: 1px solid black; padding: 0 2px;">4</span>	Output voltage: e.g. 15=1.5V 18=1.8V 45=4.5V

## MARKING DESRIPTON

$\bar{F}$ : Product Code

X: Output Voltage Code (for SC70-5, SOT23-3, SOT23-5)

Vout	Code	Vout	Code	Vout	Code
1.0V	0	2.3V	$\bar{3}$	3.6V	$\bar{6}$
1.1V	1	2.4V	$\bar{4}$	3.7V	$\bar{7}$
1.2V	2	2.5V	$\bar{5}$	3.8V	$\bar{8}$
1.3V	3	2.6V	$\bar{6}$	3.9V	$\bar{9}$
1.4V	4	2.7V	$\bar{7}$	4.0V	$\bar{0}$
1.5V	5	2.8V	$\bar{8}$	4.1V	$\bar{1}$
1.6V	6	2.9V	$\bar{9}$	4.2V	$\bar{2}$
1.7V	7	3.0V	$\bar{0}$	4.3V	$\bar{3}$
1.8V	8	3.1V	$\bar{1}$	4.4V	$\bar{4}$
1.9V	9	3.2V	$\bar{2}$	4.5V	$\bar{5}$
2.0V	$\bar{0}$	3.3V	$\bar{3}$		
2.1V	$\bar{1}$	3.4V	$\bar{4}$		
2.2V	$\bar{2}$	3.5V	$\bar{5}$		

XX: Output Voltage (for DFN1X1-4 and DFN1.2x1.6-4)."18"stands for 1.8V,"28" stands for 2.8V,and "2 $\bar{8}$ " stands for 2.85V.

Z: The Year of manufacturing,"1" stands for year 2011,"2" stands for year 2012, and "8" stands for year 2018.

Z: The week of manufacturing. "A" stands for week 1,"Z" stands for week 26," $\bar{A}$ " stands for week 27," $\bar{Z}$ " stands for week 52.

## PIN CONFIGURATION

Product Classification	BL8563-□□PQ
$\bar{F}$ : Product Code	
X: Output Voltage	
ZZ: Date Code	
Product Classification	BL8563-□□PRM
F: Product Code	
X: Output Voltage	
ZZ: Date Code	
Product Classification	BL8563-□□PRA
$\bar{F}$ : Product Code	
X: Output Voltage	
ZZ: Date Code	
Product Classification	BL8563CKETR□□
XX: Output Voltage	
Product Classification	BL8563CKFTR□□
XX: Output Voltage	
Vin	Supply Voltage Input
Vout	Output Voltage
CE	Chip Enable
NC	No Connection

## ABSOLUTE MAXIMUM RATING

Parameter		Value
Max Input Voltage		8V
Operating Junction Temperature(Tj)		125°C
Output Current		300mA
Ambient Temperature(Ta)		-40°C –85°C
Power Dissipation	SC70-5	250mW
	SOT-23-3	250mW
	SOT-23-5	250mW
	DFN1x1-4	600mW
	DFN1.2x1.6-4	800mW
Storage Temperature(Ts)		-40°C -150°C
Lead Temperature & Time		260°C,10S

### Note:

Heat Sink Area of PCB for DFN1x1-4 and DFN1.2x1.6-4 is recommended at least 2.5mmx4mm.

Exceed these limits to damage to the device.

Exposure to absolute maximum rating conditions may affect device reliability.

## RECOMMENDED WORK CONDITIONS

Item	Min	Recommended	Max.	Unit
Input Voltage Range	2		6	V
Ambient Temperature*	-40		85	°C

\*The operation ambient temperature range is verified on several test samples. Not a test condition for volume production whose test is only performed under 25°C.

## ELECTRICAL CHARACTERISTICS

(Test Conditions: Cin=1uF,Cout=1uF,TA=25°C, unless otherwise specified. )

BL8563, For Arbitrary Output Voltage

Symbol	Parameter		Conditions	Min	Typ	Max	Units
Vin	Input Voltage			2		6	V
Vout	Output Voltage	Vout>1.5V	Vin=Set Vout+1V 1mA≤Iout≤30mA	Vout x0.98	Vout	Vout X1.02	V
		Vout≤1.5V		Vout -0.03		Vout +0.03	
Iout (Max.)	Maximum Output Current		Vin-Vout=1V	300			mA
Vdrop <sup>1</sup>	Dropout Voltage,Vout≥2.8V		Iout=100mA		100	150	mV
			Iout=300mA		300	400	mV
$\frac{\Delta V_{out}}{\Delta V_{in} \cdot V_{out}}$	Line Regulation		Iout=40mA 2.8V≤Vin≤6V		0.05	0.2	%/V
$\Delta V_{out} / \Delta I_{out}$	Load Regulation		Vin=Set Vout+1V 1mA≤Iout≤300mA		50	80	mV
Iss	Supply Current		Vin=Set Vout+1V		35	80	uA
Istandby	Supply Current (Srandby)		Vin=Set Vout+1V Vce=Vss		0.1	1.0	uA

$\frac{\Delta V_{out}}{\Delta T \cdot V_{out}}$	Output Voltage Temperature Coefficient	$I_{out}=30mA$		$\pm 100$		ppm/°C
PSRR	Ripple Rejection	F=1KHz, Ripple=0.5Vp-p Vin=Set Vout+1V		70		dB
Ilim	Current Limit		300			mA
Vceh	CE Input Voltage "H"		1.5		Vin	V
Vcel	CE Input Voltage "L"		0		0.25	V
en	Output Noise	BW=10Hz~100kHz		47		uVrms
Rdischarge	Discharge Resistor	CE=0, Vout=3.0V		1.5K		ohm
Rcepd	CE pin pull down resistor	CE=Vin=5V		500K		ohm

**NOTE:**

$V_{drop} = V_{in1} - (V_{out2} * 0.98)$   $V_{out2}$  is the output voltage when  $V_{in} = V_{out1} + 1.0V$  and  $I_{out} = 300mA$ .

$V_{in1}$  is the input voltage at which the output voltage becomes 98% of  $V_{out1}$  after gradually decreasing the input voltage.

## BLOCK DIAGRAM

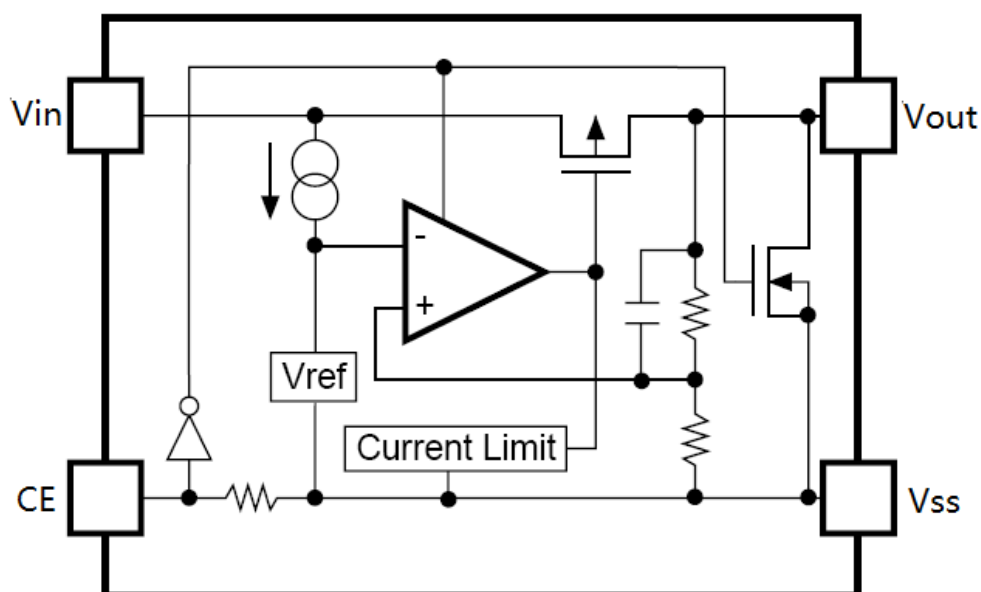

## EXPLANATION

BL8563 series is a group of positive voltage output, low noise, low power consumption, low dropout voltage regulator.

BL8563 can provide output value in the range of 1.0V~4.5V every 0.1V step. It also can be customized on command.

BL8563 includes high accuracy voltage reference, error amplifier, current limit circuit and output driver module.

BL8563 has excellent load and line transient response and good temperature characteristics, which can assure the stability of chip and power system. And it uses trimming technique to guarantee output voltage accuracy within  $\pm 2\%$ .

## TYPICAL PERFORMANCE CHARACTERISTICS ( $T=25^{\circ}C$ )

### Load Regulation ( $V_{out}=3.3V$ )

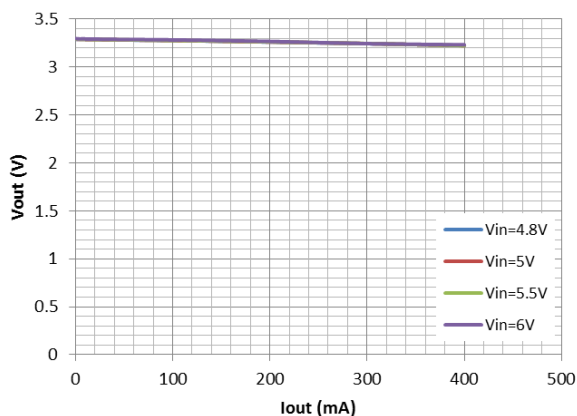

### Load Regulation ( $V_{out}=2.8V$ )

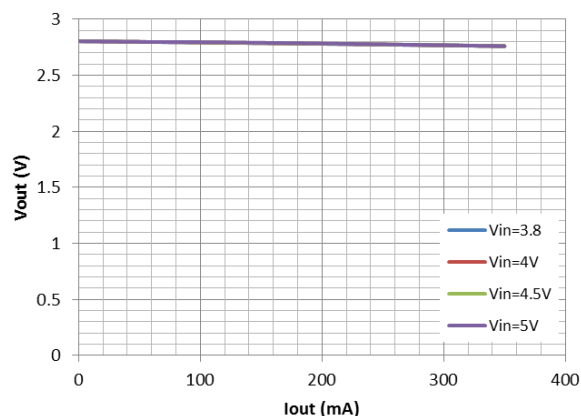

### Load Regulation ( $V_{out}=1.0V$ )

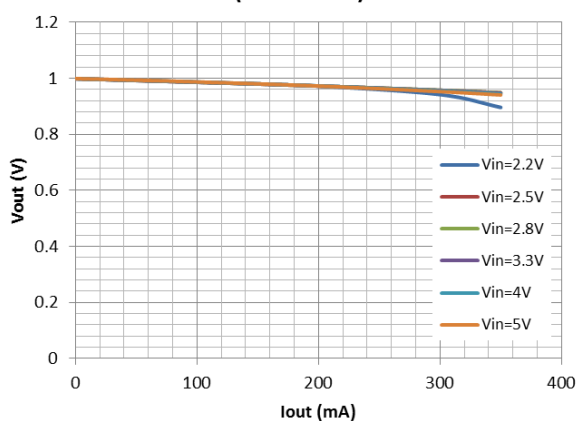

### Line Regulation ( $I_{out}=0mA$ )

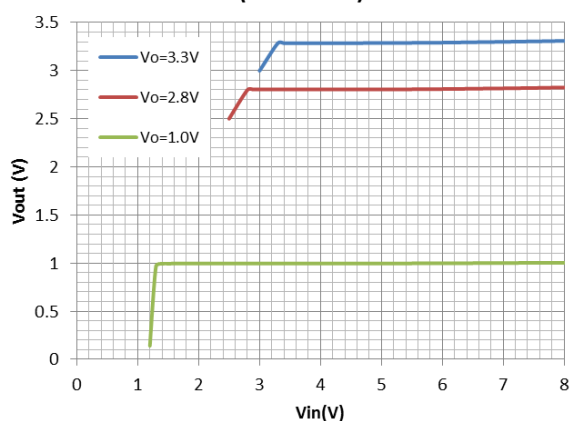

### Quiescent Current ( $I_{out}=0mA$ and $CE=high$ )

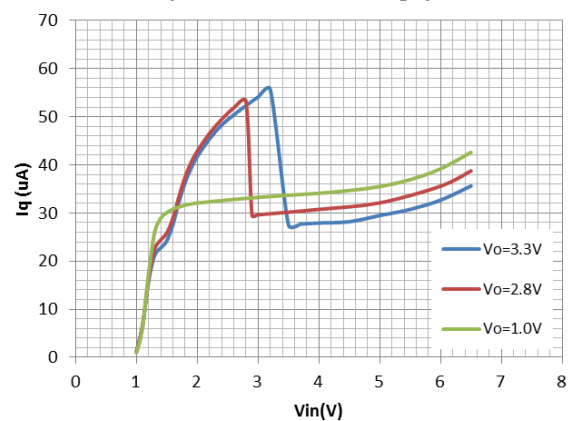

### Dropout Voltage ( $V_{out}=3.3V$ )

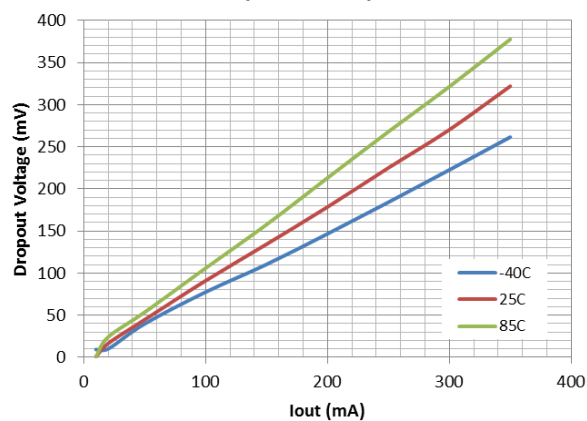

## Dropout Voltage

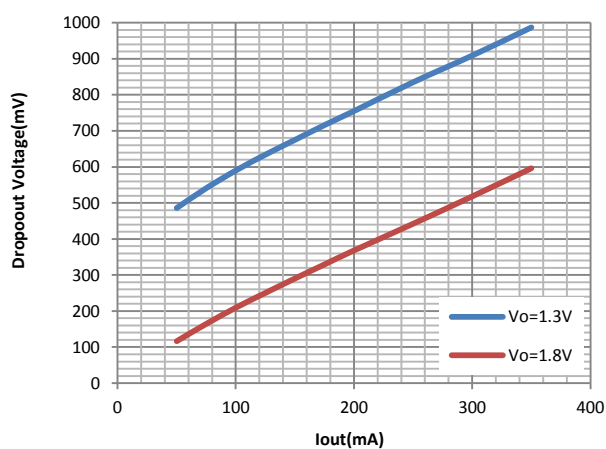

## Vout Temperature Coefficient (Vout=3.3V)

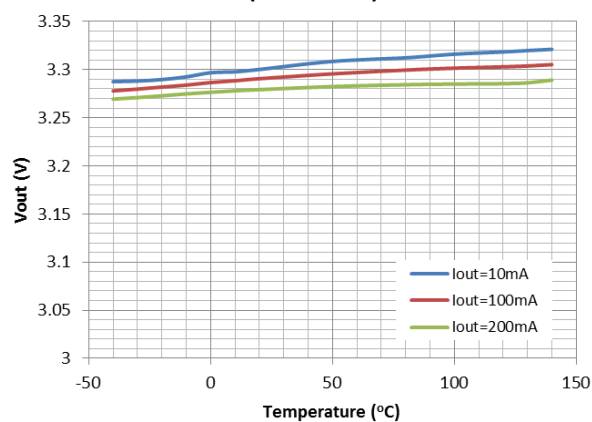

## Line Transient Response

Vout=3.3V, Iout=20mA  
(brown: Vin; Red: Vout)

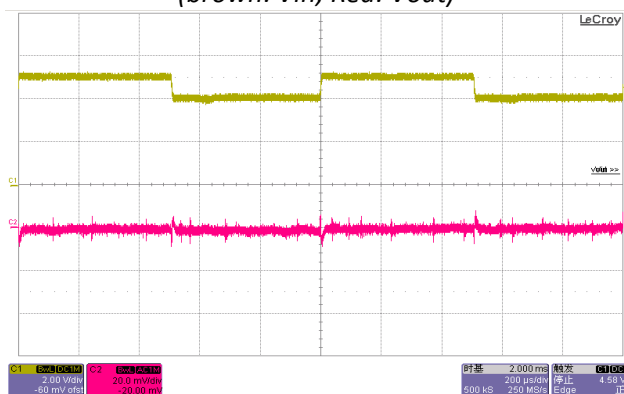

## Load Transient Response

Vin=5V, Vout=3.3V, Iout=1-100mA  
(Green: Iout; Red: Vout)

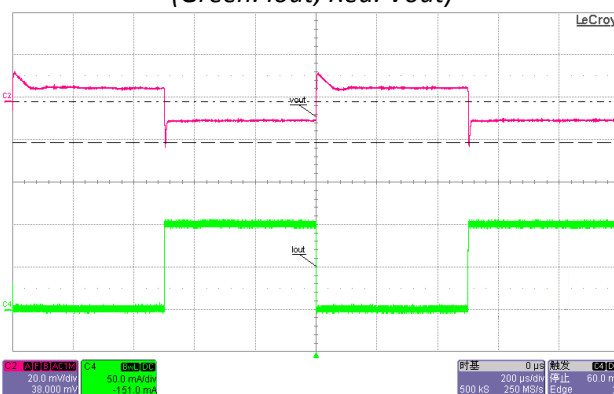

## CE Chip Enable Response

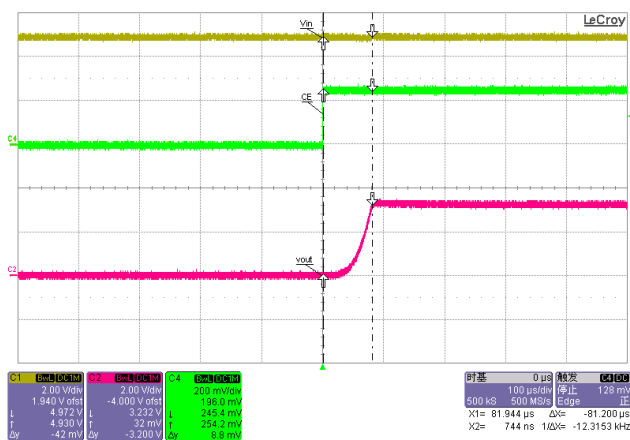

## PACKAGE OUTLINE

Package	SC70-5	Devices per reel	3000Pcs	Unit	mm
Package dimension:					

Package	SOT-23-5	Devices per reel	3000Pcs	Unit	mm
Package Dimension:					

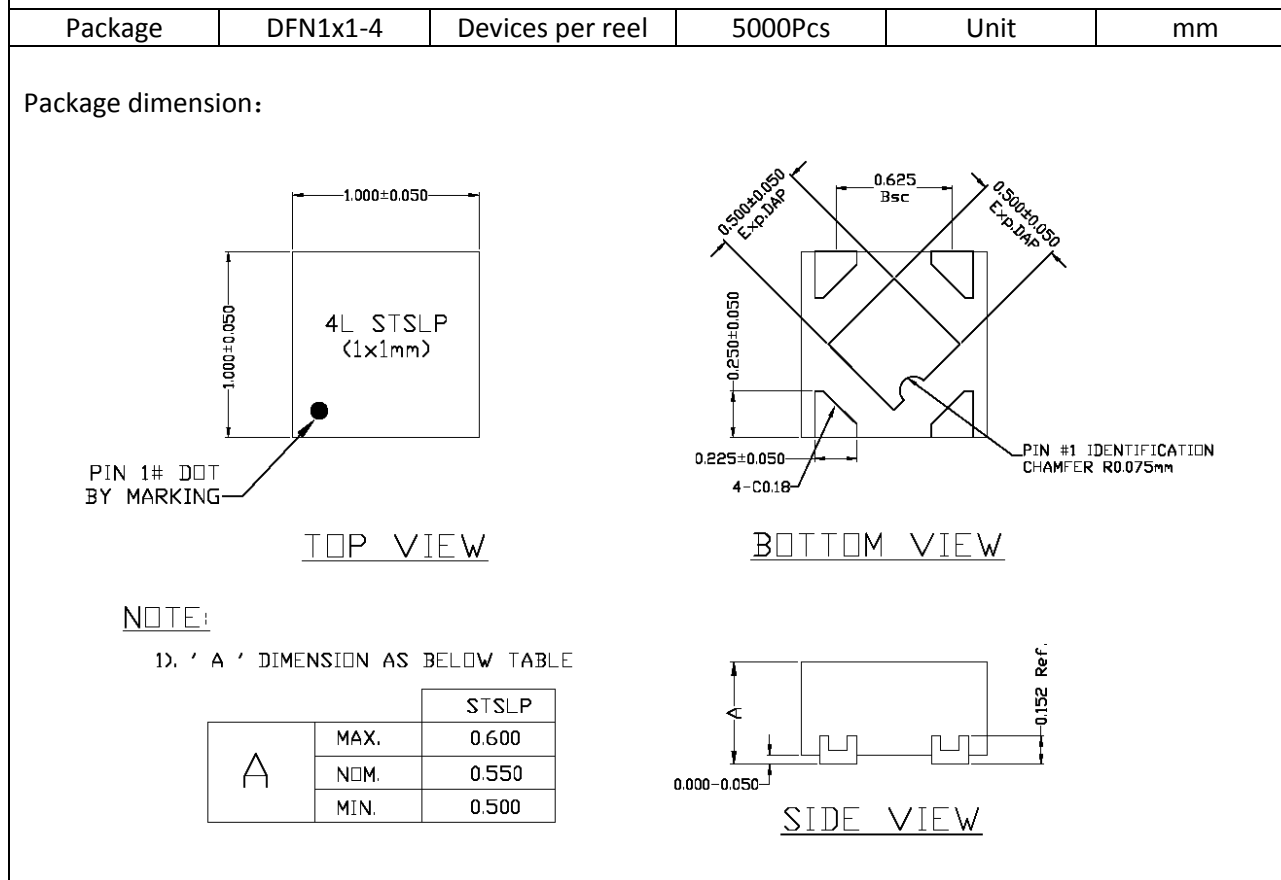
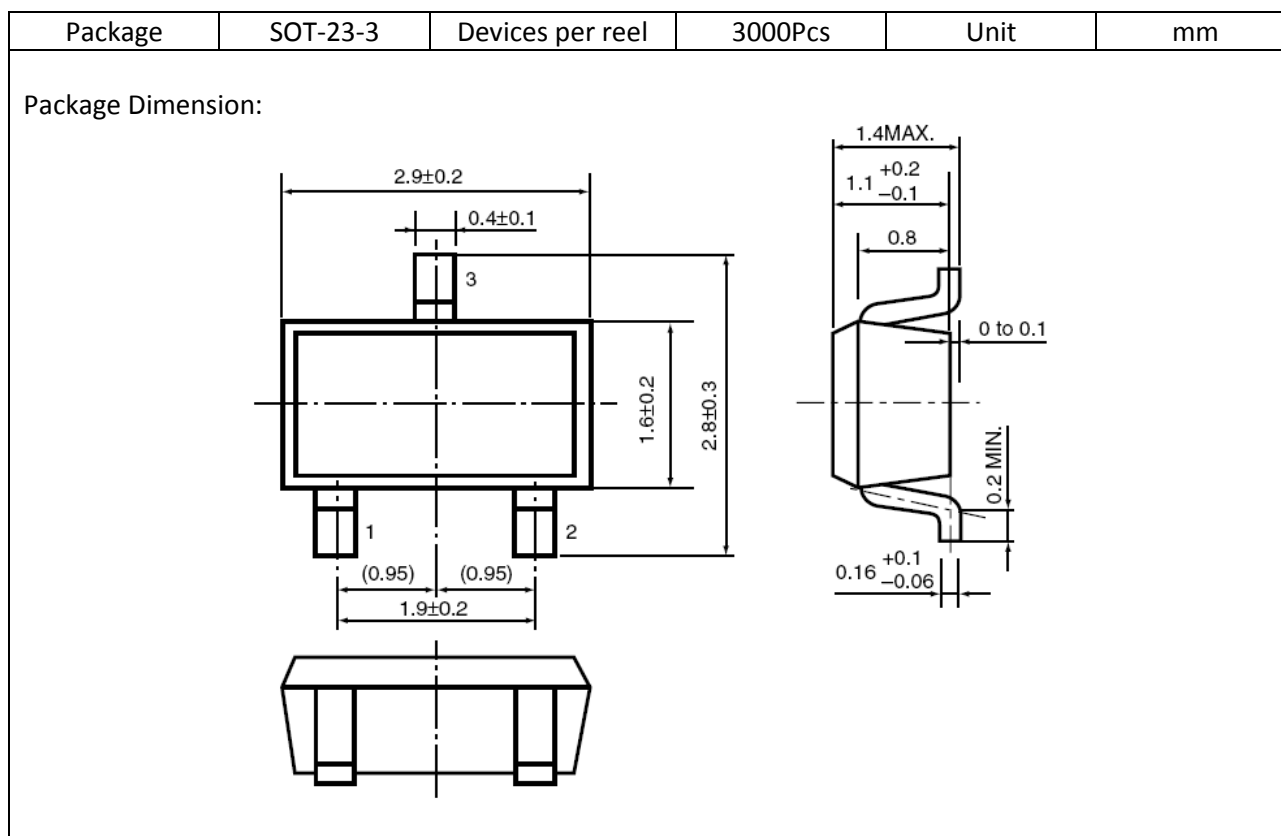



# BL8563

