

REV.	MODIFICATION	DATE	DRAW
A	INITIAL RELEASE	2012.03.22	Coco
B	ECN-2013014,ECN-2013021	2013.09.25	Coco
C	ECN-2014005	2014.04.14	Carol

HALOGEN FREE LEAD FREE

A

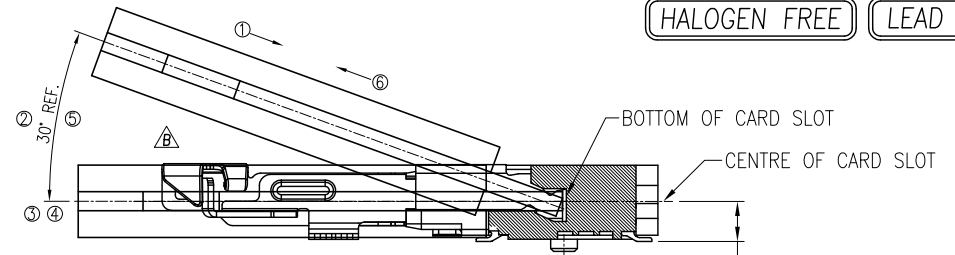
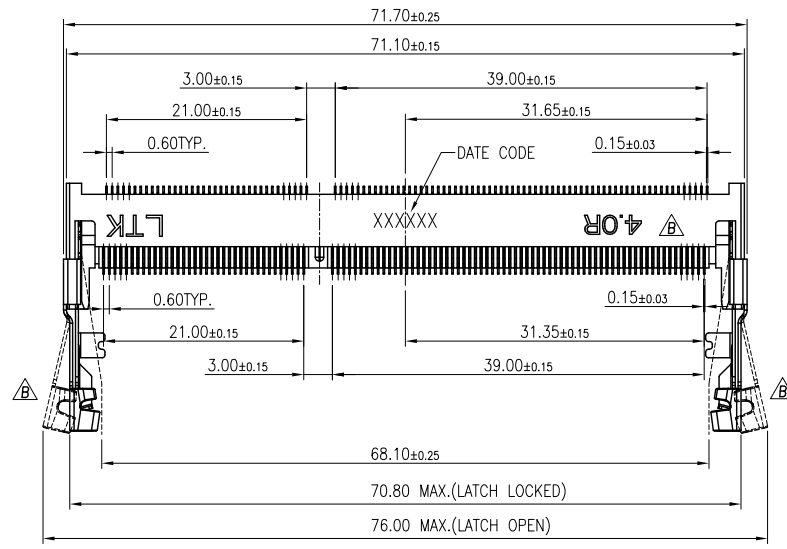

MATING: ① INSERTING(30°) → ② ROTATING → ③ FIXED
 UNMATING: ④ UNFIXED → ⑤ ROTATING → ⑥ WITHDRAWING
 MATING/UNMATING VIEW
 SCALE 2:1

B

B

C

C

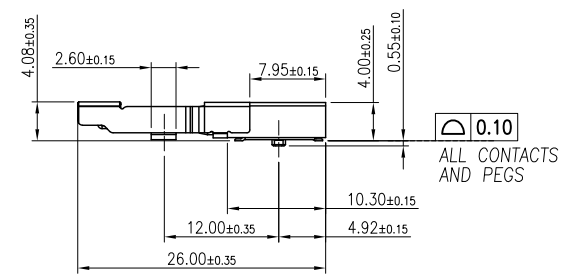
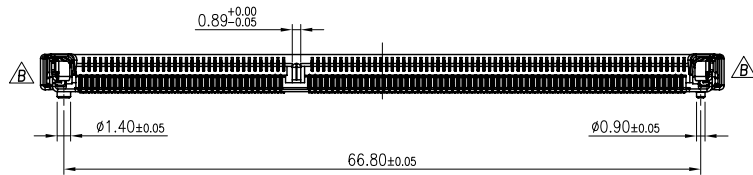

- NOTES
- MATERIAL
 HOUSING: THERMOPLASTIC UL94V-0 COLOR BLACK
 CONTACT: COPPER ALLOY, T=0.15mm.
 LATCH: SUS, T=0.30mm.
 PEG: SUS, T=0.30mm.
 - FINISH
 CONTACT: GOLD PLATING ON CONTACT AREA AND 1~3u" GOLD PLATING ON SOLDER AREA
 50~150u" NICKEL UNDER-PLATING OVER ALL
 PEG: 80~150u" MATTE TIN PLATING OVER ALL
 50~150u" NICKEL UNDER-PLATING OVER ALL
 - MSL LEVEL:
 MSL(MOISTURE SENSITIVITY LEVEL)=1.
 - PART NO. : DS2RK-204XX-XX4B

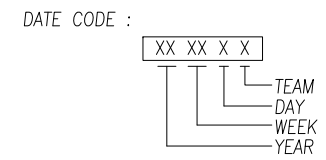

- PLATING CONTACT
- 01 : GOLD FLASH
 - 05 : GOLD 5u"Min.
 - 10 : GOLD 10u"Min.
- PACKING
- TR: TRAY
 - TP: TAPE REEL

LINKTEK

E

E

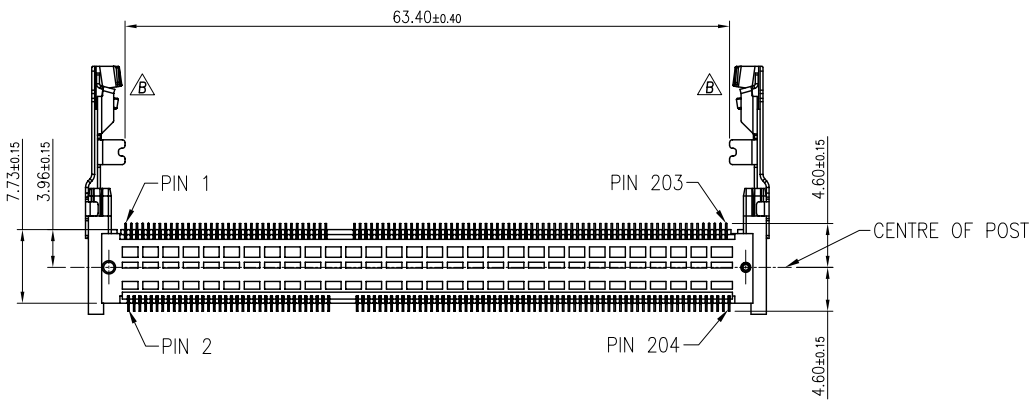

DIMENSION IN mm [Inch]		PROD. SPEC.
TOLERANCE UNLESS OTHERWISE SPECIFIED		SP-DSXXXL1
.X±0.35	X.*±1*	PKG. SPEC. PK-DSXXX-001
.XX±0.25	.X.*±	APR. Tony 2014.04.14
.XXX±	.XX.*±	CHK. Leon 2014.04.14
		DRA. Carol 2014.04.14

ARGOSY RESEARCH INC.

TITLE: DDR III 4.0H RVS CONNECTOR			
FILE NO. ARG-136	DWG NO. DS2RK-204XX-XX4B		
PROJ.	CUSTOMER DRAWING		
SIZE A4	SCALE 1:1	SHEET 1/3	REV. C C

F

F

REV.	MODIFICATION	DATE	DRAW
A	INITIAL RELEASE	2012.03.22	Coco
B	ECN-2013014, ECN-2013021	2013.09.25	Coco
C	ECN-2014005	2014.04.14	Carol

HALOGEN FREE **LEAD FREE**

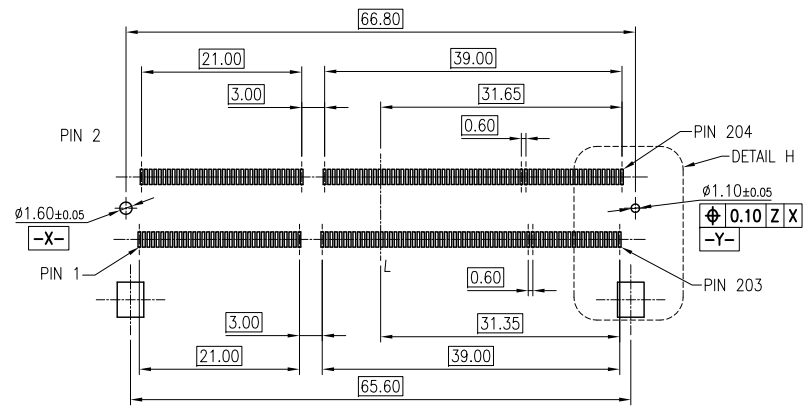
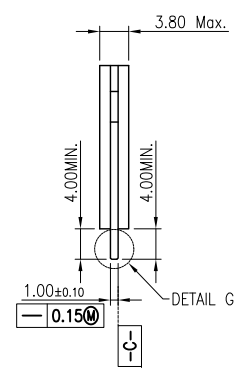
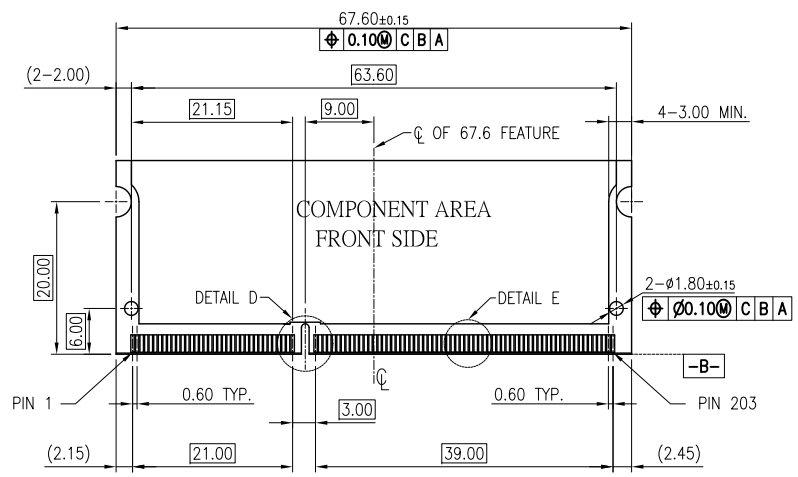

RECOMMEND P.C. BOARD LAYOUT
 PCB THICKNESS 0.80mm Min.
 TOLERANCE: ±0.05
 (-Z-): PCB SURFACE

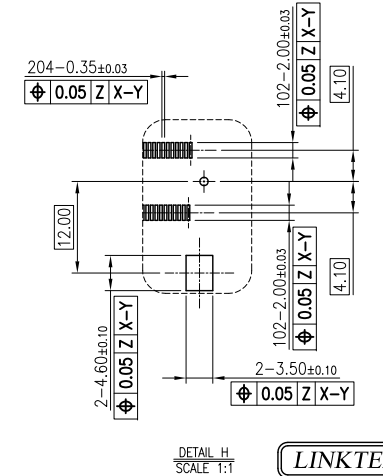
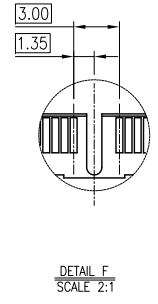
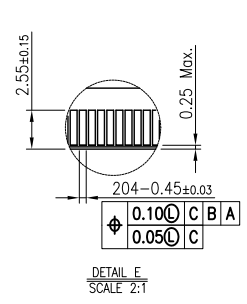
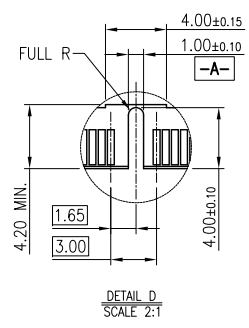
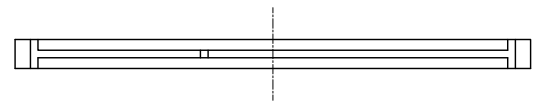

LINKTEK

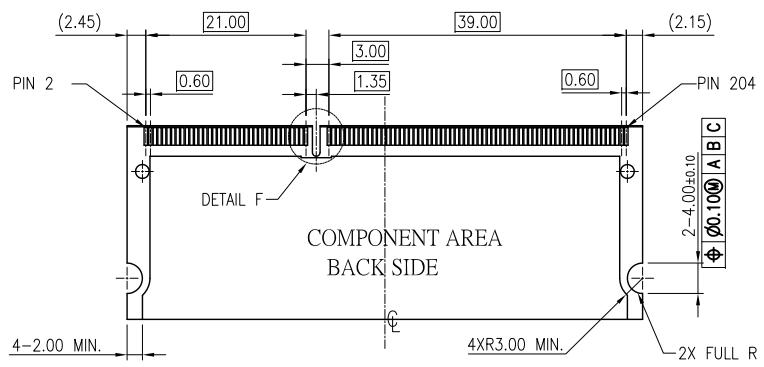

RECOMMEND MODULE CONFIGURATION

DIMENSION IN mm [Inch]		PROD. SPEC.
TOLERANCE UNLESS OTHERWISE SPECIFIED		SP-DSXXXL1
		PKG. SPEC.
		PK-DSXXX-001
.X±0.35	X.*± 1*	APR. Tony 2014.04.14
.XX±0.25	.X.*±	CHK. Leon 2014.04.14
.XXX±	.XX.*±	DRA. Carol 2014.04.14

ARGOSY RESEARCH INC.

TITLE: DDR III 4.0H RVS CONNECTOR

FILE NO. ARG-136 DWG NO. DS2RK-204XX-XX4B

PROJ. CUSTOMER DRAWING

SIZE A4 SCALE 1:1 SHEET 2/3 REV. C C

REV.	MODIFICATION	DATE	DRAW
A	INITIAL RELEASE	2012.03.22	Coco
B	ECN-2013014,ECN-2013021	2013.09.25	Coco
C	ECN-2014005	2014.04.14	Carol

HALOGEN FREE LEAD FREE

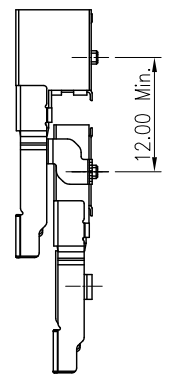
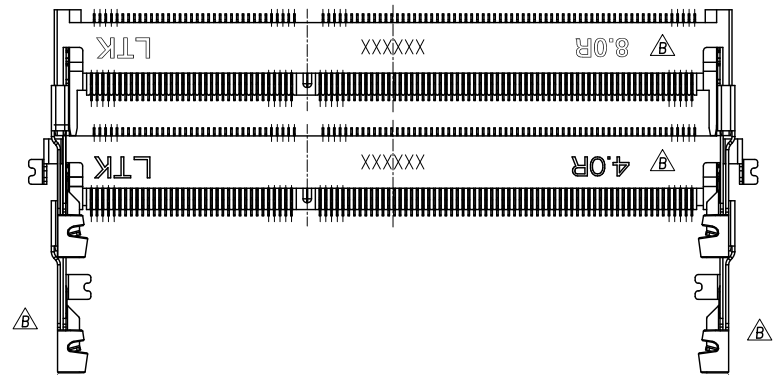
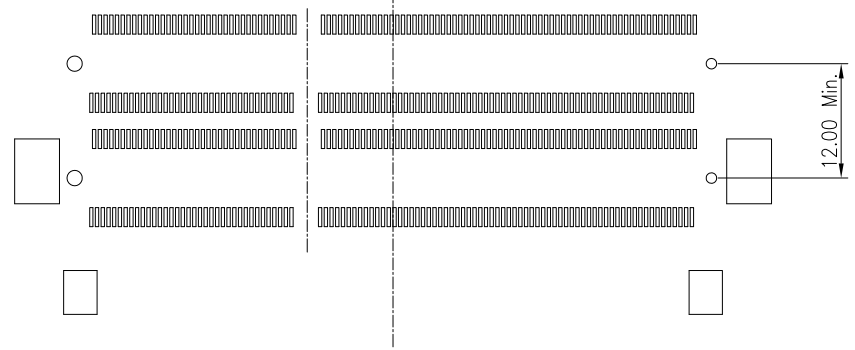

LINKTEK

DIMENSION IN mm [Inch]		PROD. SPEC. SP-DSXXXL1	ARGOSY RESEARCH INC.			
TOLERANCE UNLESS OTHERWISE SPECIFIED		PKG. SPEC. PK-DSXXX-001				
.X±0.35	X.*± 1°	APR. Tony 2014.04.14	TITLE: DDR III 4.0H RVS CONNECTOR			
.XX±0.25	.X.*±	CHK. Leon 2014.04.14	FILE NO. ARG-136	DWG NO. DS2RK-204XX-XX4B		
.XXX±	.XX.*±	DRA. Carol 2014.04.14	PROJ.	CUSTOMER DRAWING		
			SIZE A4	SCALE 1:1	SHEET 3/3	REV. C C