

BF 2012 Series (Preliminary)

Multilayer Chip Band-Pass Filters

Features

- ❖ Ultra small SMD type with low loss at pass-band and high attenuation at stop-band.

Applications

- ❖ 2.4 GHz wireless communication systems, including, WLAN card, Bluetooth modules, etc.

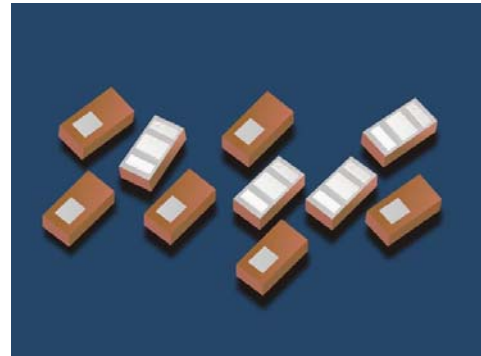

Specifications

Part Number	Frequency Range (MHz)	Insertion Loss @ BW (dB)	Return Loss @ BW (dB)	Frequency	Attenuation (dB)
BF2012-L2R4NDA_	2400 ~ 2500	1.6 typ. 2.0 max. @ 25°C	10 min.	824 ~ 915MHz	30 min.
				1545 ~ 1605MHz	30 min.
				1710 ~ 1990MHz	33 min.
				2170MHz	25 min.
				4800 ~ 5000MHz	40 min.
				7200 ~ 7500MHz	25 min.

Q'ty/Reel (pcs) : 4,000
 Operating Temperature Range : -40 ~ +85 °C
 Storage Temperature Range : -40 ~ +85 °C
 Storage Period : 12 months max.*
 *12 months in vacuum sealed bag and 1 week after opened. Please keep unused parts in vacuum sealed bags.
 Solder Paste : SAC 305 type is recommended.
 Power Capacity : 2W max.

Part Number

BF 2012 - L 2R4 NDA □ /LF
 ① ② ③ ④ ⑤ ⑥ ⑦

① Type	BF : Band-Pass Filter	② Dimensions (L x W)	2.0 x1.2 mm
③ Material Code	L	④ Frequency Range	2R4=2400MHz
⑤ Specification Code	NDA	⑥ Packaging	T: Tape & Reel B: Bulk
⑦ Soldering	=lead-containing /LF=lead-free		

Terminal Configuration

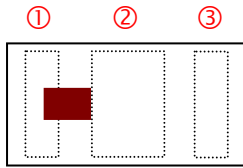

No.	Terminal Name	No.	Terminal Name
①	IN	③	OUT
②	GND		

Dimensions and Recommended PC Board Pattern

Unit : mm

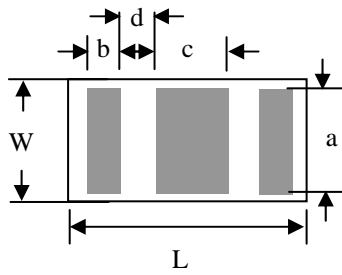

< Bottom View >

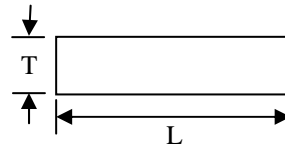

< Side View >

Mark	L	W	T	a	b	c	d
Dimensions	2.0 ± 0.15	1.25 ± 0.10	0.8 max.	0.95 ± 0.1	0.275 ± 0.1	0.6 ± 0.1	0.25 ± 0.05

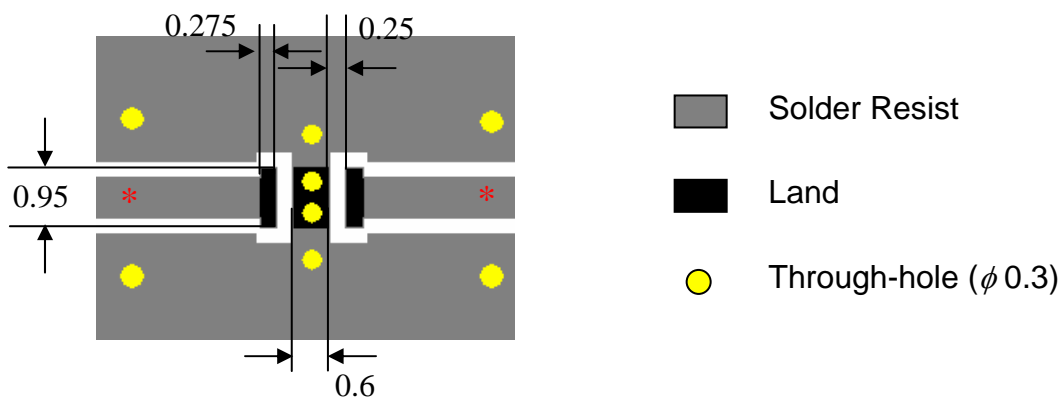

* Line width should be designed to match 50 Ω characteristic impedance, depending on PCB material and thickness.

Measuring Diagram

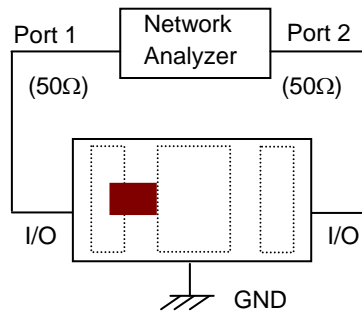

Electrical Characteristics (T=25°C)

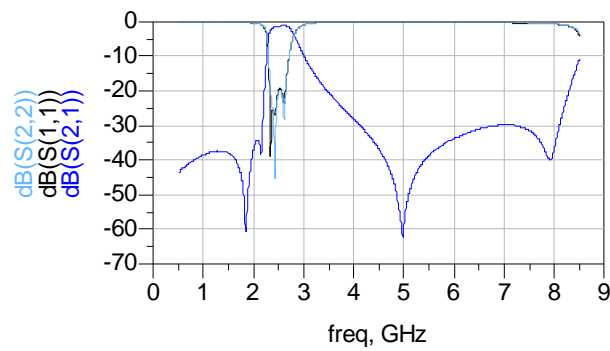

Notes

- ❖ The contents of this data sheet are subject to change without notice. Please confirm the specifications and delivery conditions when placing your order.

Taping Specifications

❖Tape Dimensions (Unit: mm) & Quantity

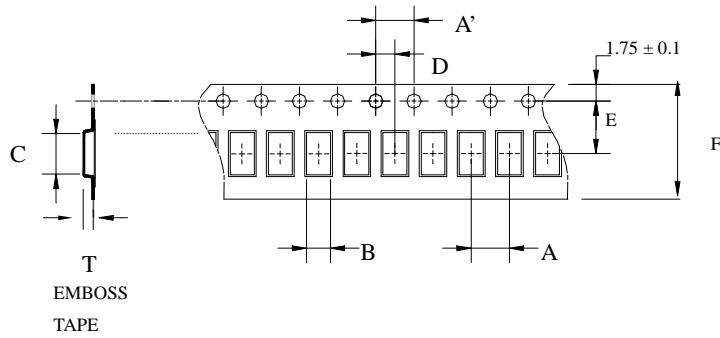

Type	A	A'	B	C	D	E	F	T	Quantity/reel	Tape material
2012	4.0± 0.1	4.0± 0.1	1.35± 0.05	2.15± 0.05	2.0± 0.05	3.5± 0.1	8.0± 0.1	1.00± 0.05	4,000pcs	Plastic (Embossed)

❖Reel Dimensions (Unit: mm)

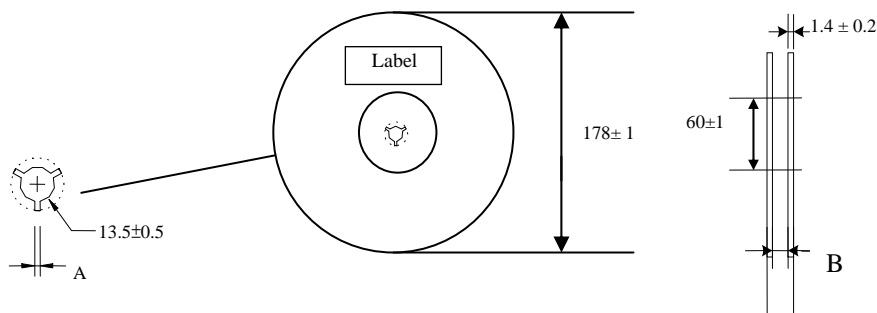

Type	A	B
2012	2.3±0.5	9.0±0.3

❖Leader and Trailer Tape

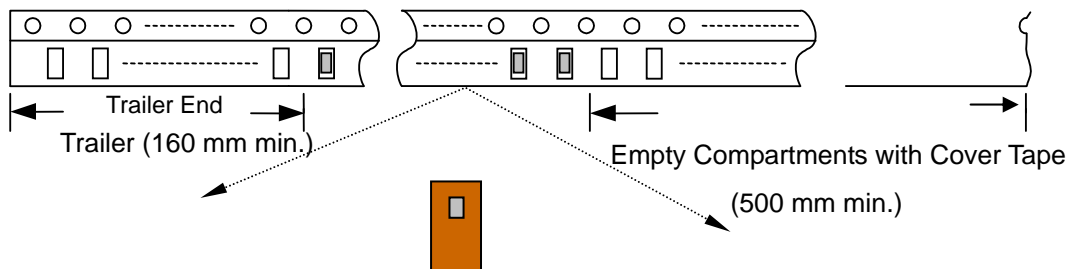

❖ **Peel-off Force**

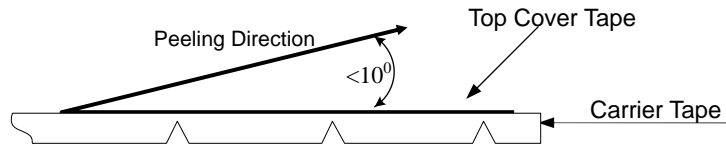

Peel-off force should be in the range of 0.1 – 0.6 N at a peel-off speed of 300 ± 10 mm/min .

❖ **Storage Conditions**

- (1) Temperature: $+5 \sim 35^{\circ}\text{C}$, relative humidity (RH): 45~75%.
- (2) Non-corrosive environment.

Notes

- ❖ The contents of this data sheet are subject to change without notice. Please confirm the specifications and delivery conditions when placing your order.

Mechanical & Environmental Characteristics

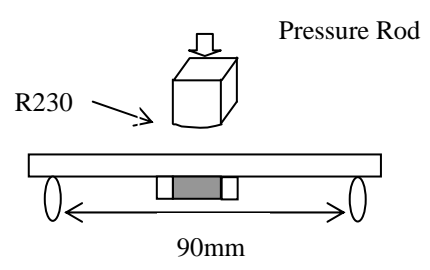
Item	Requirements	Procedure
Solderability	<ol style="list-style-type: none"> No apparent damage More than 75% of the terminal electrode shall be covered with new solder 	<ol style="list-style-type: none"> Preheat: $120 \pm 5^\circ\text{C}$ Solder: $245 \pm 5^\circ\text{C}$ for 5 ± 1 sec
Soldering strength (Termination Adhesion)	<ol style="list-style-type: none"> 1kg minimum 	<ol style="list-style-type: none"> Solder specimen onto test jig. Apply push force at 0.5mm/s until electrode pads are peeled off or ceramic are broken. Pushing force is applied to longitude direction
Deflection (Substrate Bending)	<ol style="list-style-type: none"> No apparent damage Fulfill the electrical specification 	<ol style="list-style-type: none"> Solder specimen onto test jig (FR4, 0.8mm) using the recommend soldering profile. Apply a bending force of 2mm deflection 
Heat/Humidity Resistance	<ol style="list-style-type: none"> No apparent damage Fulfill the electrical specification after test 	<ol style="list-style-type: none"> Temperature: $85 \pm 2^\circ\text{C}$ Humidity: 90% ~ 95% RH Duration: 1000 ± 48hrs Recovery: 1-2hrs
Thermal shock (Temperature Cycle)	<ol style="list-style-type: none"> No apparent damage Fulfill the electrical specification after test 	<ol style="list-style-type: none"> One cycle/step 1 : $125 \pm 5^\circ\text{C}$ for 30 min step 2 : $-40 \pm 5^\circ\text{C}$ for 30 min No of cycles : 100 Recovery: 1-2 hrs
Low Temperature Resistance	<ol style="list-style-type: none"> No apparent damage Fulfill the electrical specification after test 	<ol style="list-style-type: none"> Temperature: $-40 \pm 5^\circ\text{C}$ Duration: 500 ± 24hrs Recovery: 1-2hrs

Soldering Conditions

❖ Typical Soldering Profile for Lead-free Process

Reflow Soldering :

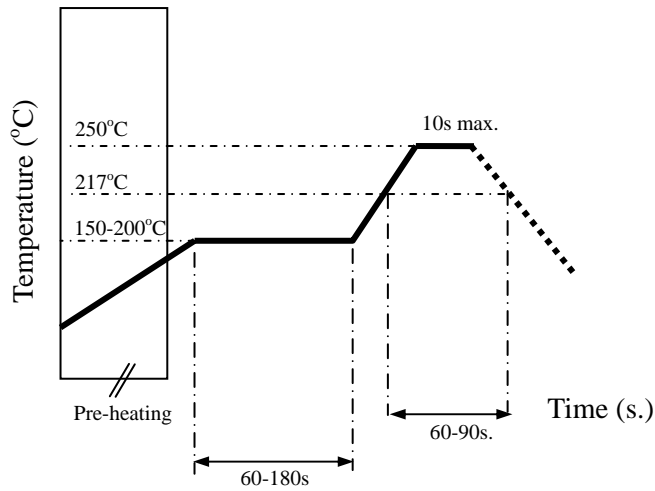

Notes

❖ The contents of this data sheet are subject to change without notice. Please confirm the specifications and delivery conditions when placing your order.

Advanced Ceramic X Corp.

16 Tzu Chiang Road, Hsinchu Industrial District Hsinchu Hsien 303, Taiwan

TEL:886-3-5987008 FAX:886-3-5987001

E-mail: acx@acxc.com.tw

<http://www.acxc.com.tw>