

ELECTRONICS

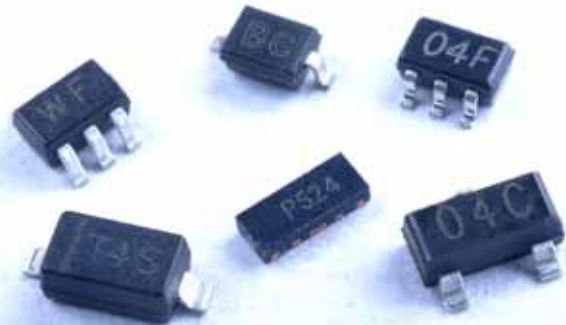

# TVS/ESD Arrays

RLSD12AxxxC Series

## TVS/ESD Arrays - RLSD12AxxxC Series

### Features

- 350 Watts peak pulse power ( $t_p = 8/20\mu s$ )
- Transient protection for data lines to  
IEC 61000-4-2 (ESD)  $\pm 15kV$  (air),  $\pm 8kV$  (contact)  
IEC 61000-4-4 (EFT) 40A (5/50ns)  
IEC 61000-4-5 (Lightning) 24A (8/20 $\mu s$ )
- Small package for use in portable electronics
- Suitable replacement for MLV's in ESD protection applications
- Protects one I/O or power line
- Solid-state silicon avalanche technology



### Mechanical Characteristics

- SOD-123 package
- Molding compound flammability rating: UL 94V-0
- Packaging: Tape and Reel per EIA 481
- Lead Finish: Matte tin
- RoHS Compliant

### Applications

- Personal digital assistants (PDA)
- Cellular handsets & Accessories
- Portable devices
- Portable instrumentation
- Handhelds and notebooks
- Digital cameras

### Life Support Note

- Not Intended for Use in Life Support or Life Saving Applications
- The products shown herein are not designed for use in life sustaining or life saving applications unless otherwise expressly indicated

### Pinout and Functional Block Diagram

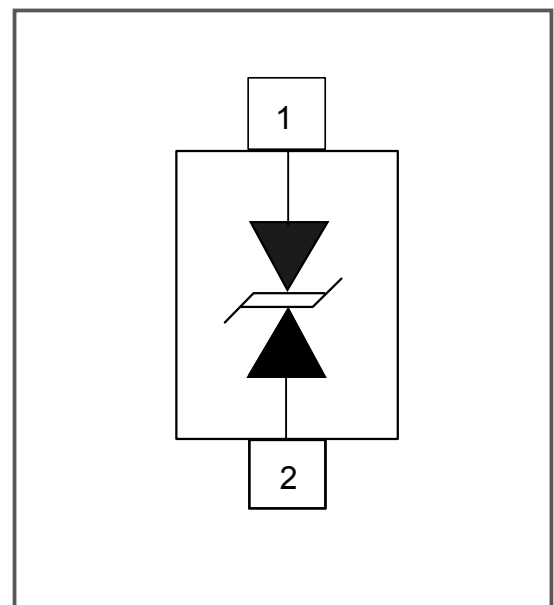

## TVS/ESD Arrays - RLSD12AxxxC Series

## Absolute Maximum Rating

| Rating                                | Symbol           | Value       | Units |
|---------------------------------------|------------------|-------------|-------|
| Peak pulse power (tp=8/20μs waveform) | Ppk              | 200         | Watts |
| ESD voltage (HBM contact)             | V <sub>ESD</sub> | ±25         | Kv    |
| operating temperature range           | T <sub>J</sub>   | -55 to +125 | °C    |
| Storage temperature range             | T <sub>STG</sub> | -55 to +150 | °C    |

## Electrical Characteristics Per Lin (@ 25°C Unless Otherwise Specified)

| Type Number | Peak Power<br>Dissipation<br>@8/20μS<br>Pppm | Reverse<br>Stand-Off<br>Voltage | Peak Pulse<br>Voltage<br>@8/20μS | Peak Pulse<br>Current<br>@8/20μS | Reverse<br>Leakage<br>@Vrwm | Maximum<br>Capacitance<br>@1MHZ |
|-------------|--|---------------------------------|----------------------------------|----------------------------------|-----------------------------|---------------------------------|
|             |  | Vrwm                            | Vc@IPP                           | IPP                              | IR@Vrwm                     | Co                              |
|             |  | Max                             |                                  |                                  | Max                         | Max                             |
|             | W  | V                               | V                                | A                                | μA                          | pF                              |
| RLSD12A051C | 400  | 5                               | 7.5                              | 5                                | 20                          | 235                             |
| RLSD12A121C | 400  | 12                              | 14.5                             | 5                                | 1                           | 185                             |
| RLSD12A151C | 400  | 15                              | 19                               | 5                                | 1                           | 165                             |
| RLSD12A241C | 400  | 24                              | 29                               | 5                                | 1                           | 120                             |

# TVS/ESD Arrays - RLSD12AxxxC Series

## Typical Characteristics

Figure 1. Peak Pulse Power Rating Curve

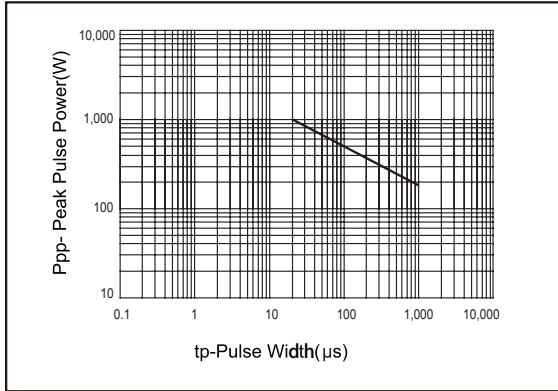

Figure 2. 10/1000µs Pulse Waveforms

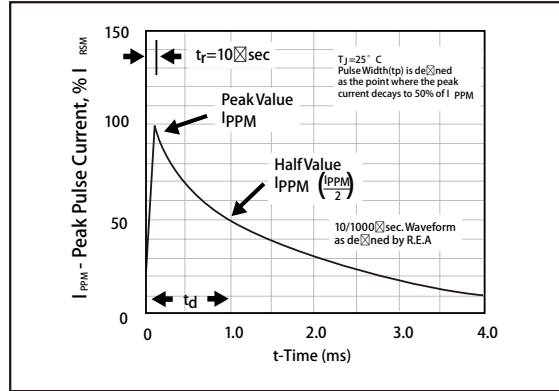

Figure 3. 8/20µs Pulse Waveforms

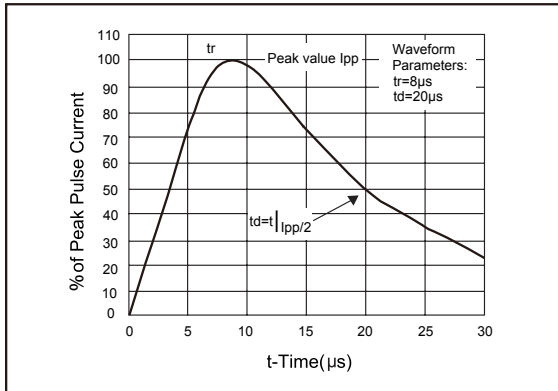

Figure 4. Power Derating Curve

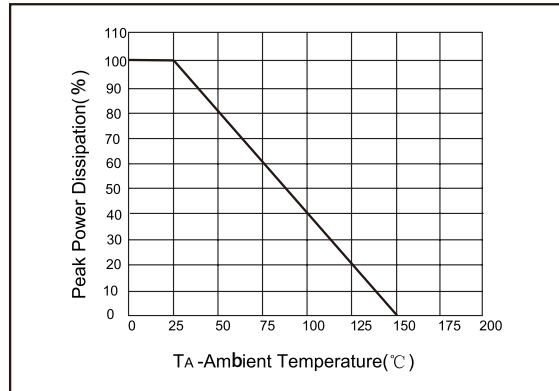
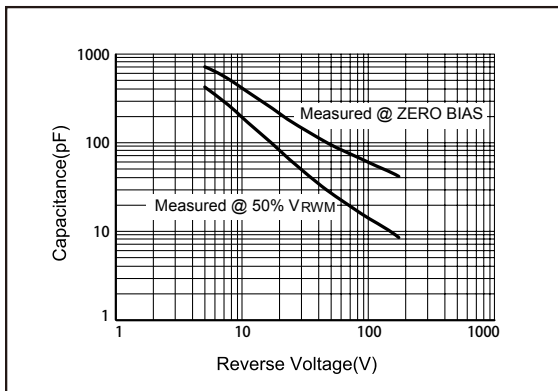
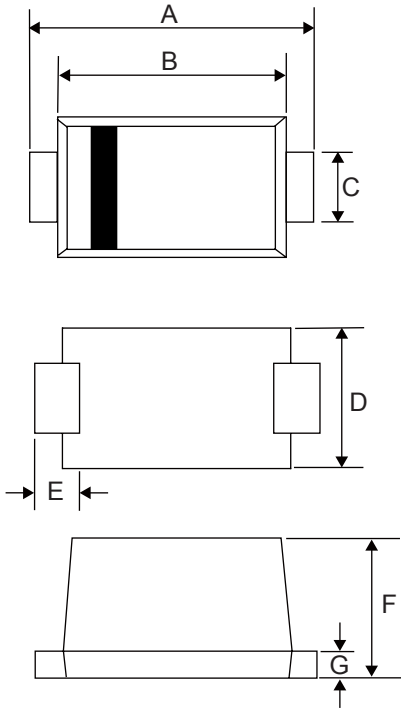

Figure 5. Capacitance vs. Reverse Voltage



## TVS/ESD Arrays - RLSD12AxxxC Series

### Package dimension SOD-123



| Dimensions |          |       |             |      |
|------------|----------|-------|-------------|------|
| Symbol     | Inches   |       | Millimeters |      |
|            | Min      | Max   | Min         | Max  |
| A          | 0.138    | 0.154 | 3.50        | 3.90 |
| B          | 0.102    | 0.118 | 2.60        | 3.00 |
| C          | 0.030    | 0.037 | 0.75        | 0.95 |
| D          | 0.063    | 0.079 | 1.60        | 2.00 |
| E          | 0.031typ |       | 0.80typ     |      |
| F          | 0.035    | 0.039 | 0.90        | 1.05 |
| G          | 0.007    | 0.009 | 0.18        | 0.22 |

### Recommended soldering footprint

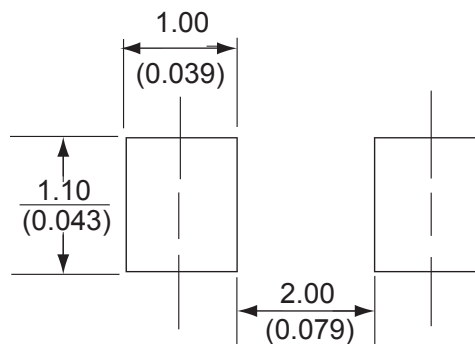

# TVS/ESD Arrays - RLSD12AxxxC Series

## Part Number Code

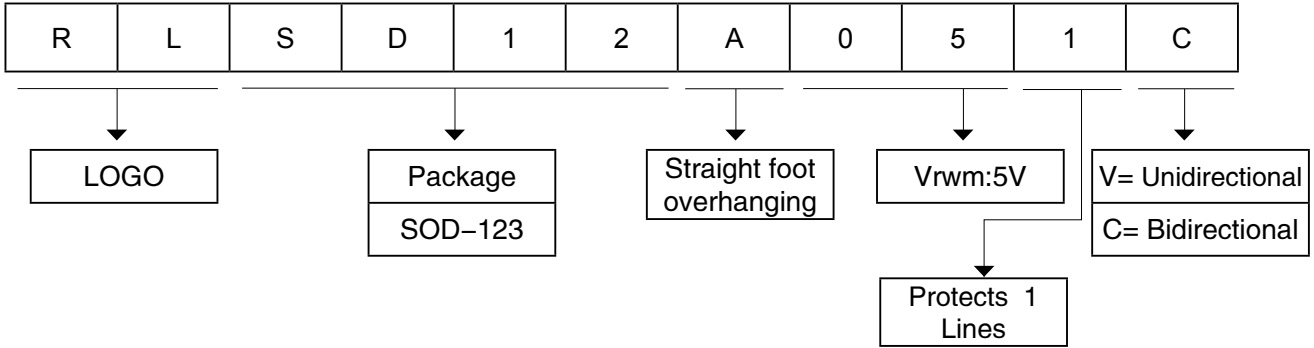

## Tape and reel

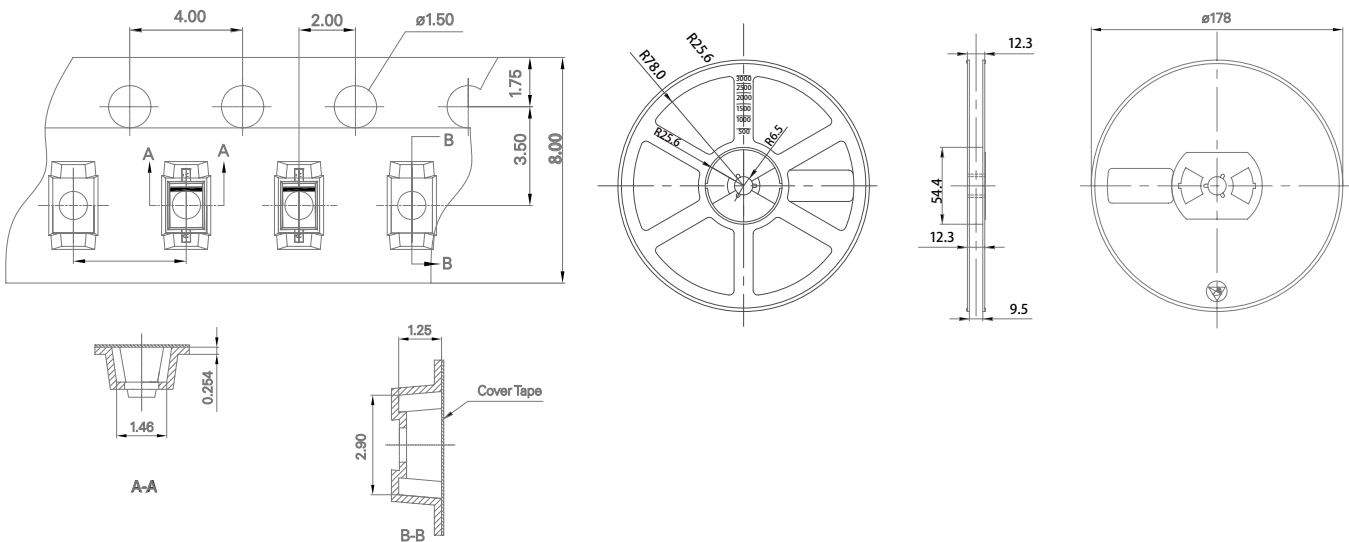

## Ordering Information

| Part Number | Package | Min. Order Qty. |
|-------------|---------|-----------------|
| RLSD12AxxxC | SOD-123 | 3000pcs         |

## Warehouse Storage Conditions of Products

- Storage Conditions:
- 1. Storage Temperature: -10°C~+40°C
- 2. Relative Humidity: ≤75%RH
- 3. Keep away from corrosive atmosphere and sunlight.
- 4. Period of Storage: 1 year

## RuiLongYuan Electronics Co., Ltd.

---

- Reproducing and modifying information of the document is prohibited without permission from Ruilongyuan International Inc.
  - Ruilongyuan International Inc. reserves the rights to make changes of the content herein the document anytime without notification. Please refer to our website for the latest document.
  - Ruilongyuan International Inc. disclaims any and all liability arising out of the application or use of any product including damages incidentally and consequentially occurred.
  - Ruilongyuan International Inc. does not assume any and all implied warranties, including warranties of fitness for particular purpose, non-infringement and merchantability.
  - Applications shown on the herein document are examples of standard use and operation. Customers are responsible in comprehending the suitable use in particular applications. Ruilongyuan International Inc. makes no representation or warranty that such applications will be suitable for the specified use without further testing or modification.
  - The products shown herein are not designed and authorized for equipments requiring high level of reliability or relating to human life and for any applications concerning life-saving or life-sustaining, such as medical instruments, transportation equipment, aerospace machinery et cetera. Customers using or selling these products for use in such applications do so at their own risk and agree to fully indemnify Ruilongyuan International Inc. for any damages resulting from such improper use or sale.
-