



GENERAL DESCRIPTION

The SDB9HB is a step-up converter designed for driving up to 7 series white LEDs from a single cell Lithium Ion battery. The SDB9HB uses current mode, fixed frequency architecture to regulate an LED current, which is measured through an external current sense resistor. Its low 200mV feedback voltage reduces power loss and improves efficiency.

The SDB9HB includes under-voltage lockout, current limiting and thermal overload protection preventing damage in the event of an output overload.

Optimized operation frequency can meet the requirement of small LC filters value and low operation current with high efficiency. Internal soft start function can reduce the inrush current. Tiny package type provide the best solution for PCB space saving and total BOM cost.

FEATURES

- High Efficiency: Up to 90%
- 1.20MHz Constant Frequency Operation
- Integrated internal Power MOSFET
- Drives up to 7 Series WLEDs
- Low 200mV Feedback Voltage
- Soft-start/Dimming with wide Frequency Range
- UVLO, Thermal Shutdown
- Internal Current limit
- Over Voltage Protection
- Small LC Filter
- Minimize the External Component
- $1\mu A$ Shutdown Current
- SOT23-6 Package

APPLICATIONS

- Camera Flash White LED
- Mobile Phone, Smart Phone LED Backlight
- PDA LED Backlight
- Digital Still Cameras
- Camcorder

TYPICAL APPLICATION

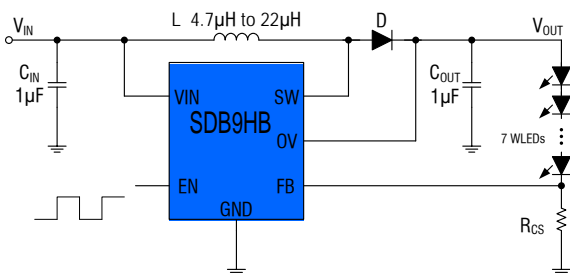
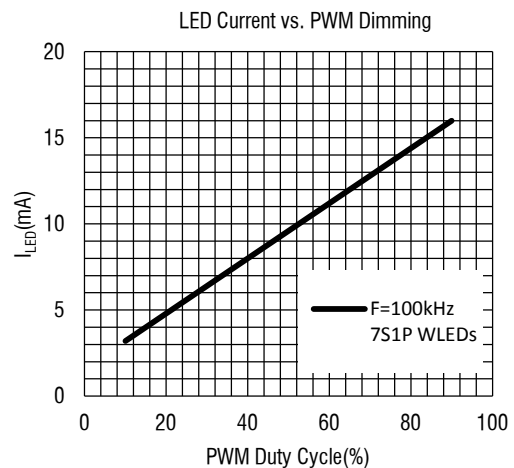

Figure 1. Basic Application Circuit





ABSOLUTE MAXIMUM RATINGS (Note 1)

Junction Temperature(Note2).....	160°C	Input Supply Voltage.....	-0.3V to 25V
Operating Temperature Range.....	-40°C to 85°C	EN,FB Voltages.....	-0.3V to 6V
Lead Temperature(Soldering,10s).....	300°C	SW Voltage.....	-0.3V to 30V
Storage Temperature Range.....	-65°C to 150°C	Power Dissipation.....	0.6W
ESD HBM(Human Body Mode).....	2kV	Thermal Resistance θ_{JC}	130°C/W
ESD MM(Machine Mode).....	200V	Thermal Resistance θ_{JA}	250°C/W

PACKAGE/ORDER INFORMATION

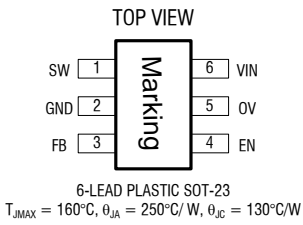
	Order Part Number	Package
<p style="text-align: center;">TOP VIEW</p> 	SDB9HB	SOT23-6

PIN DESCRIPTION

Pin Name	Pin Number	Description
SW	1	Inductor Connection. Connect to the switched side of the external inductor as well as the anode of the external diode. SW is high impedance during shutdown.
GND	2	Ground Pin.
FB	3	Current-Sense Feedback Input. Connect a resistor from FB to GND to set the LED current: $I_{LED} = 0.2V/R_{CS}$
EN	4	Enable and LED Brightness Control Input. Pull high to turn on IC. Drive EN with a 20kHz to 1MHz unfiltered PWM dimming signal for DC LED current that is proportional to the signal's duty cycle.
OV	5	Over Voltage Input. The SDB9HB turn off the N-channel MOSFET when V_{OUT} exceeds 28V .Connect OV to the output at the top of the LED string.
VIN	6	Power Supply Input. Must be closely decoupled to GND with a 1μF or greater ceramic capacitor.

**ELECTRICAL CHARACTERISTICS**(Note 3)(V_{IN}=V_{EN}=3.7V, T_A = 25°C, unless otherwise noted.)

PARAMETER	CONDITIONS	MIN	TYP	MAX	UNIT
Operating Input Voltage		3		24	V
Under Voltage Lockout				2.6	V
Under Voltage Lockout Hysteresis			100		mV
Current (Shutdown)	V _{EN} < 0.4V			1	μA
Quiescent Current	V _{FB} = 0.15V, No switching		200		μA
Supply Current	V _{FB} = 0V, switching		0.6	1	mA
Regulated Feedback Voltage		194	200	206	mV
Switching Frequency			1.2		MHz
ON Resistance of NMOS			0.1		Ω
Peak Current Limit	V _{IN} = 4.2V, Duty cycle = 50%	2			A
EN Shutdown Voltage				0.4	V
EN Enable Voltage		1.5			V
EN Leakage Current			±0.01	±1.0	μA
OVP Threshold	Open LED, V _{OUT} Rising		28		V

Note 1: Absolute Maximum Ratings are those values beyond which the life of a device may be impaired.

Note 2: T_J is calculated from the ambient temperature T_A and power dissipation P_D according to the following formula: T_J = T_A + (P_D) x (250°C/W).

Note 3: 100% production test at 25°C. Specifications over the temperature range are guaranteed by design and characterization.

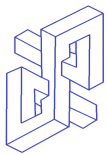

TYPICAL PERFORMANCE CHARACTERISTICS

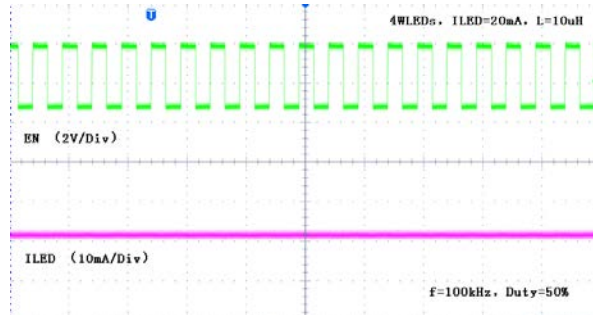
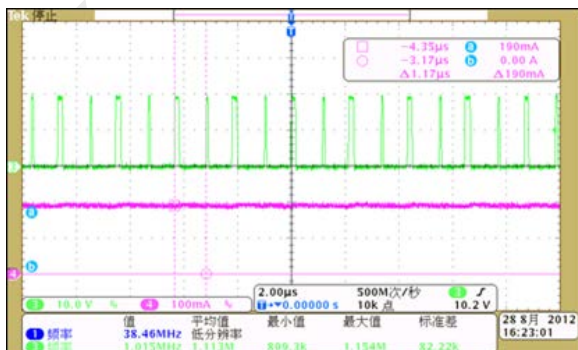
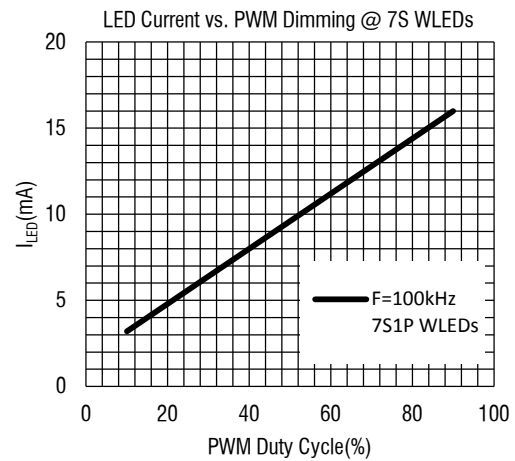
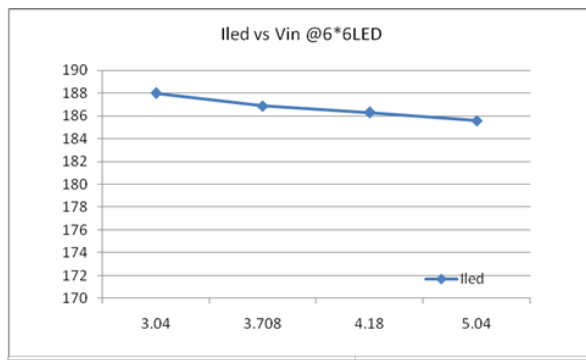
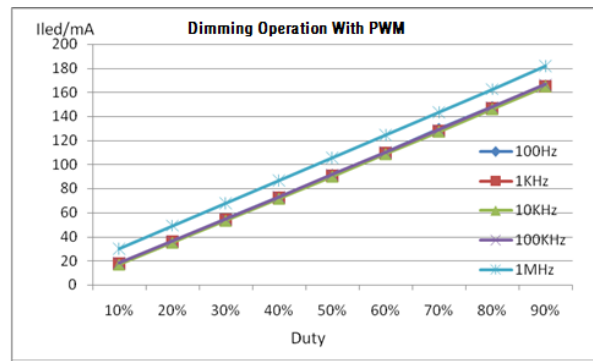
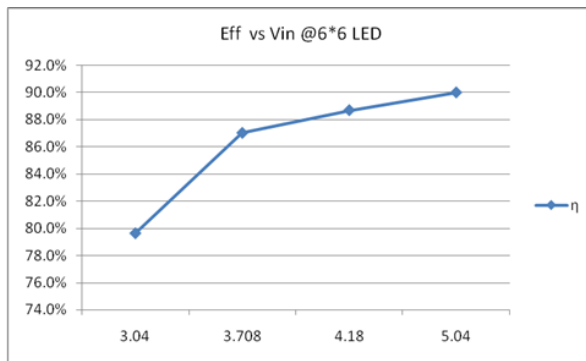

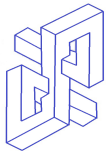

Normal Operation @ $V_{IN}=3.0V$

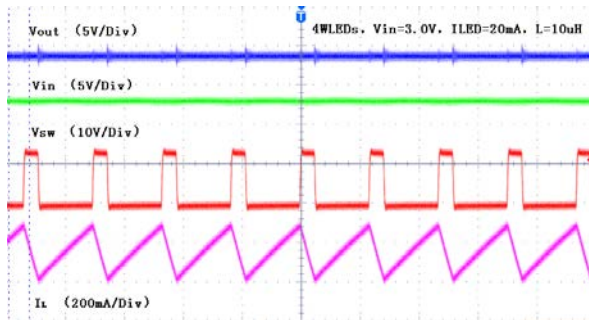

Normal Operation @ $V_{IN}=3.7V$

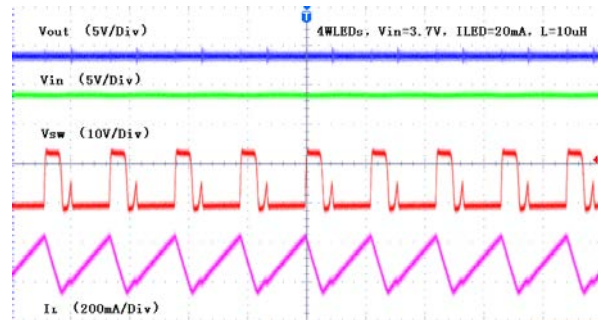

Normal Operation @ $V_{IN}=4.3V$

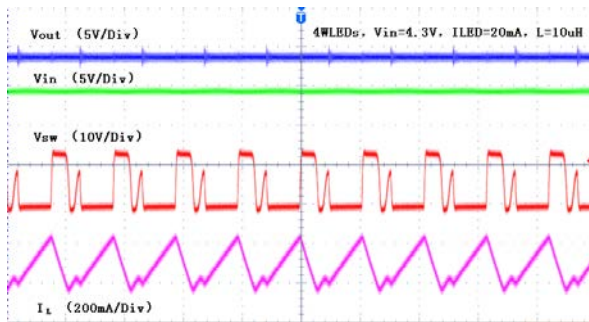

Normal Operation @ $V_{IN}=5.5V$

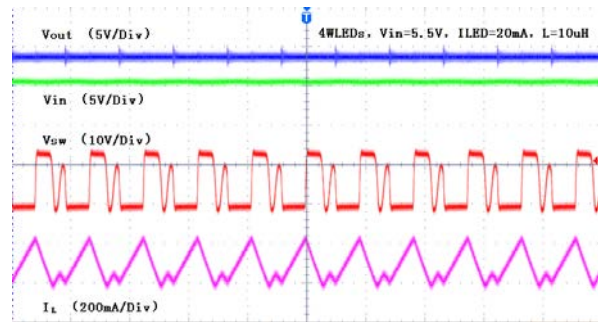



FUNCTIONAL BLOCK DIAGRAM

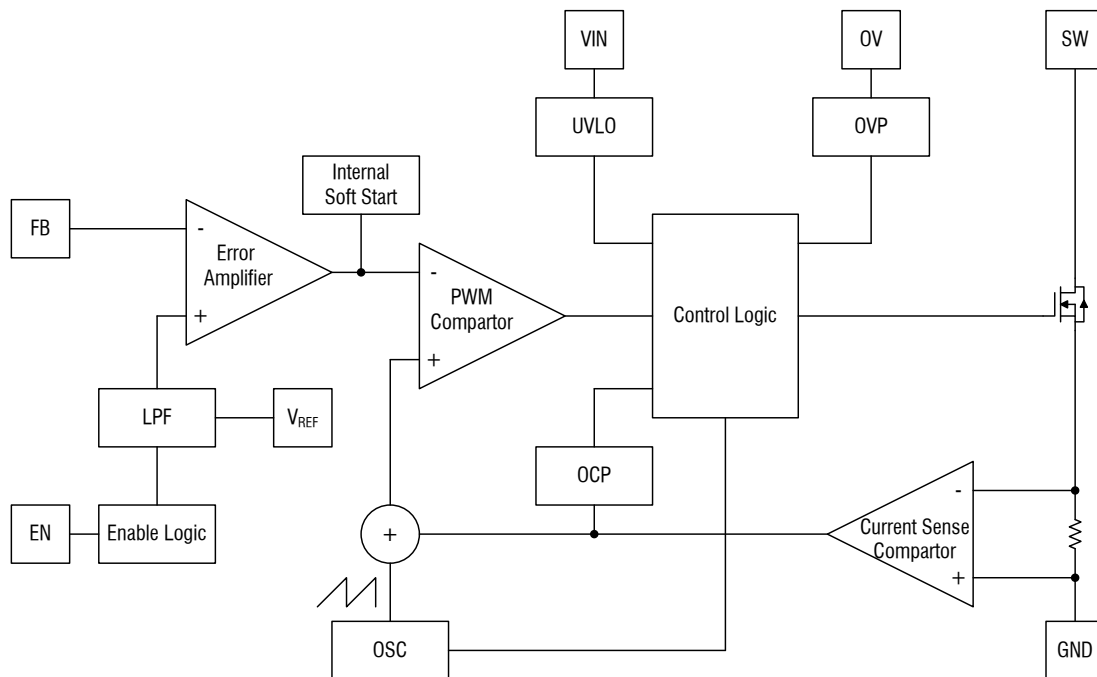

Figure 2. SDB9HB Block Diagram

FUNCTIONAL DESCRIPTION

The SDB9HB uses a constant frequency, peak current mode boost regulator architecture to regulate the series string of white LEDs. At the start of each oscillator cycle the FET is turned on through the control circuitry. To prevent sub-harmonic oscillations at duty cycles greater than 50 percent, a stabilizing ramp is added to the output of the current sense amplifier and the result is fed into the positive input of the PWM comparator.

When this voltage equals the output voltage of the error amplifier the power FET is turned off. The voltage at the output of the error amplifier is

an amplified version of the difference between the 200mV reference voltage and the feedback voltage. In this way the peak current level keeps the output in regulation. If the feedback voltage starts to drop, the output of the error amplifier increases. This results in more current flowing through the power FET, thus increasing the power delivered to the output.

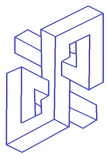

APPLICATIONS INFORMATION

Adjusting LED Current

Set the maximum LED current using a resistor from FB to GND. Calculate the resistance as follows:.

$$R_{CS} = \frac{200mV}{I_{LED}}$$

where I_{LED} is the desired maximum current through the LEDs.

I_{LED} (mA)	R_{CS} (mΩ)
1	200
5	40
10	20
15	13.3
20	10

LED Dimming Control

➤ Using a PWM Signal to EN Pin

For controlling the LED brightness, the SDB9HB can perform the dimming control by applying a PWM signal to EN pin. The internal soft start and the wide range dimming frequency can eliminate inrush current and audio noise when dimming. The average LED current is proportional to the PWM signal duty cycle. The magnitude of the PWM signal should be higher than the maximum enable voltage of EN pin, in order to let the dimming control perform correctly for preventing the flicker issue, the suggested PWM frequency is $\geq 20kHz$ and $\leq 1MHz$.

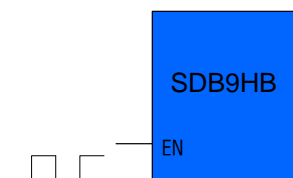

Figure 3

➤ Using a DC Voltage

Using a variable DC voltage to adjust the brightness is a popular method in some applications. According to the Superposition Theorem, as the DC voltage increases, the voltage contributed to V_{FB} increases and the voltage drop on R1 decreases, i.e. the LED current decreases. For example, if the V_{DC} range is from 0V to 2.8V, the selection of resistors sets dimming control of LED current from 20mA to 0mA. The LED current can be calculated by the following equation:

$$I_{LED} = \frac{V_{FB} - \frac{R1 \times (V_{DC} - V_{FB})}{R2}}{R_{CS}}$$

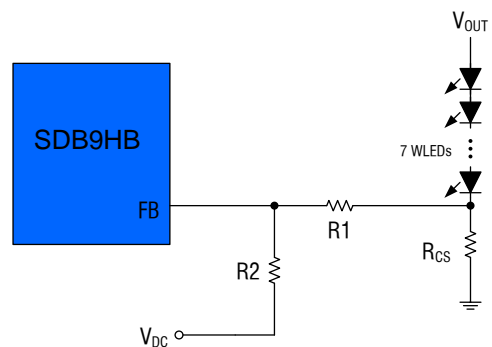

Figure4

➤ Using a Filtered PWM signal

Another common application is using a filtered PWM signal as an adjustable DC voltage for LED dimming control. A filtered PWM signal acts as the DC voltage to regulate the output current. The recommended application circuit is shown in the Figure 5. In this circuit, the output ripple depends on the frequency of PWM signal. For smaller output voltage ripple ($< 100mV$), the recommended frequency of 2.8V PWM signal should be above 20kHz. To fix the frequency of PWM signal and change the duty cycle of PWM signal can get different output current. Figure 5.



shows the relationship between LED current and PWM duty cycle. The LED current can be calculated by the following equation:

$$I_{LED} = \frac{V_{FB} - \frac{R1 \times (V_{PWM} \times Duty - V_{FB})}{R3 + R2}}{R_{CS}}$$

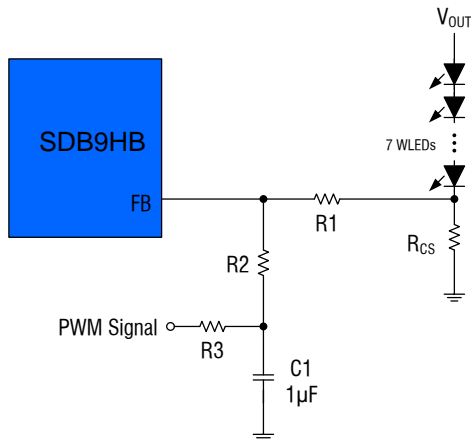

Figure5

Inductor Selection

The recommended value of inductor are 4.7 to 22µH. Small size and better efficiency are the major concerns for portable device, such as SDB9HB used for mobile phone. The inductor should have low core loss at 1.2MHz and low DCR for better efficiency. To avoid inductor saturation current rating should be considered.

Capacitor Selection

Input and output ceramic capacitors of 4.7µF are recommended for SDB9HB applications. For better voltage filtering, ceramic capacitors with low ESR are recommended. X5R and X7R types are suitable because of their wider voltage and temperature ranges.

Diode Selection

Schottky diode is a good choice for SDB9HB because of its low forward voltage drop and fast reverse recovery. Using Schottky diode can get better efficiency. The high speed rectification is

also a good characteristic of Schottky diode for high switching frequency. Current rating of the diode must meet the root mean square of the peak current and output average current multiplication as following :

$$I_D(RMS) = \sqrt{I_{OUT} \times I_{PEAK}}$$

The diode's reverse breakdown voltage should be larger than the output voltage.

Layout Consideration

For best performance of the SDB9HB, the following guidelines must be strictly followed.

- Input and Output capacitors should be placed close to the IC and connected to ground plane to reduce noise coupling.
- The GND should be connected to a strong ground plane for heat sinking and noise protection.
- Keep the main current traces as possible as short and wide.
- SW node of DC-DC converter is with high frequency voltage swing. It should be kept at a small area.
- Place the feedback components as close as possible to the IC and keep away from the noisy device

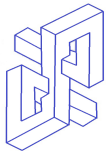

PACKAGE DESCRIPTION

SOT23-6

