

**BIDIRECTIONAL
ESD PROTECTION DIODE**

**STAND-OFF VOLTAGE - 5.0 Volts
POWER DISSIPATION - 130 Watts**

GENERAL DESCRIPTION

The L13ESD5V0CE2 is designed to protect sensitive electronics from damage or latch up due to ESD, lightning, and other voltage induced transient events. The device will protect one line operating at 5.0 volts.

FEATURES

- Bi-directional ESD protection of one line.
- Max. peak pulse power: Ppp=130w at tp = 8/20 us.
- Low clamping voltage
- IEC 61000-4-2, level 4 (ESD), >30KV(air)
; >30KV(contact)
- IEC 61000-4-5, level 1 (surge) ; Ipp=12A at tp = 8/20us.
- Qualified to AEC-Q101 Rev_C

APPLICATION

- Computers and peripherals
- Communication system
- Audio & video equipment
- Portable instrumentation

MECHANICAL DATA

- Case material: "Green" molding compound UL flammability classification 94V-0 (No Br, Sb, Cl),
- Component in accordance to RoHs 2011/65/EU
- Dimension = DFN, 1.00 mm (L)* 0.6 mm (W)

SOD-882

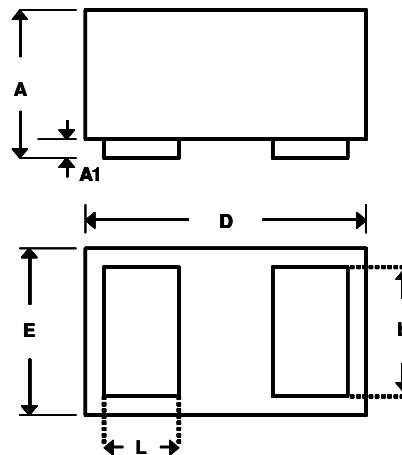

SOD-882		
DIM.	MIN.	MAX.
A	0.47	0.53
A1	0.00	0.05
b	0.25	0.55
D	0.95	1.075
E	0.55	0.675
L	0.20	0.45
All dimension in millimeter		

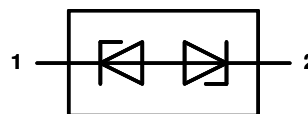

PIN ASSIGNMENT	
1	Cathode
2	Cathode

MAXIMUM RATINGS AND ELECTRICAL CHARACTERISTICS

Ratings at 25°C ambient temperature unless otherwise specified.

ABSOLUTE RATINGS

PARAMETER	SYMBOL	VALUE	UNIT
Peak pulse power (8/20us waveform)	P _{PPM}	130	W
Peak pulse current (8/20us waveform)	I _{PP}	12	A
Operating junction temperature range	T _J	-55 to +150	°C
Storage temperature range	T _{STG}	-55 to +150	°C
Soldering temperature, t max = 10s	T _L	260	°C

ELECTRICAL CHARACTERISTICS

PARAMETER	TEST CONDITIONS	SYMBOL	MIN	MAX	UNIT
Reverse standoff voltage	--	V _{DRM}	--	5.0	V
Reverse leakage current	V _{DRM} = 5V	I _{RM}	--	100	nA
Breakdown voltage	I _R = 1 mA	V _{BR}	5.5	9.5	V
Junction capacitance (each I/O pin and ground)	V _R = 0V, f = 1MHz,	C _J	--	45	pF
Clamping voltage	I _{PP} = 1A (8/20 us)	V _{CL}	--	10	V
	I _{PP} = 12A (8/20 us)		--	14	

**RATING AND CHARACTERISTIC CURVES
L13ESD5V0CE2**

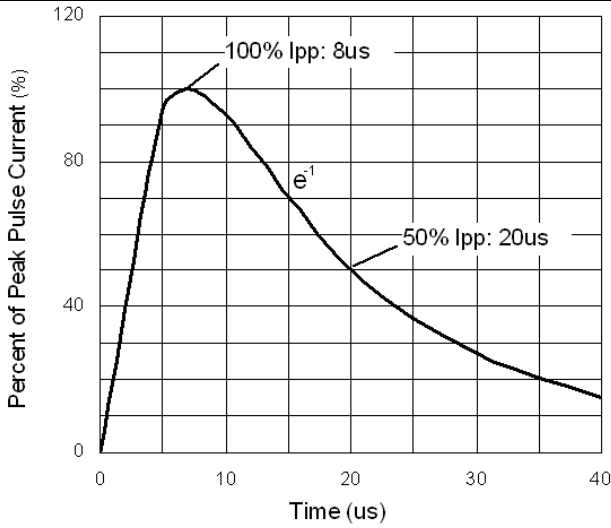

Figure 1. 8/20 us pulse waveform according to IEC 61000-4-5

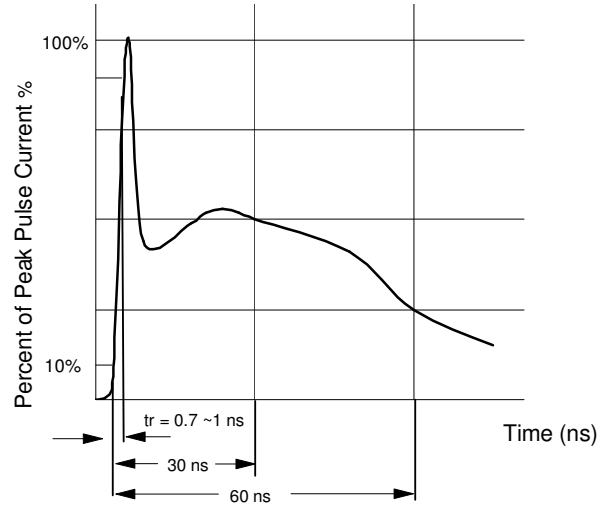

Figure 2. ESD pulse waveform according to IEC 61000-4-2

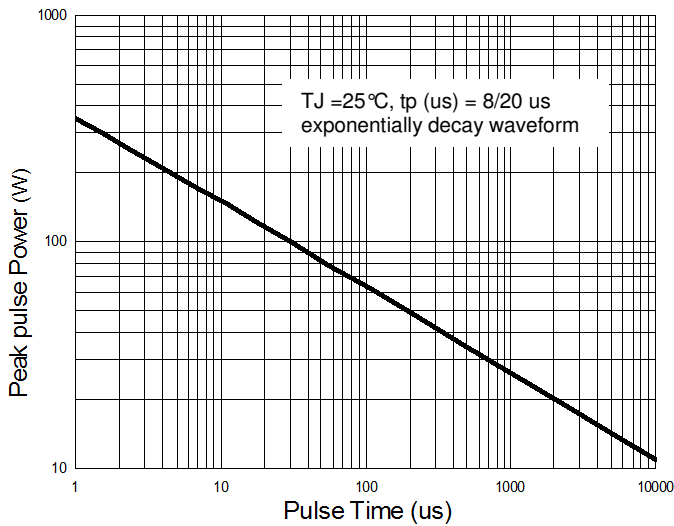

Figure 3. Power Dissipation versus Pulse Time

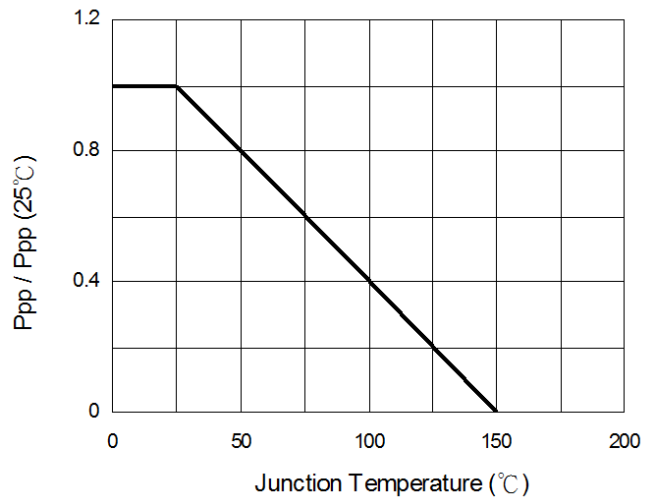

Figure 4. Peak pulse power versus TJ

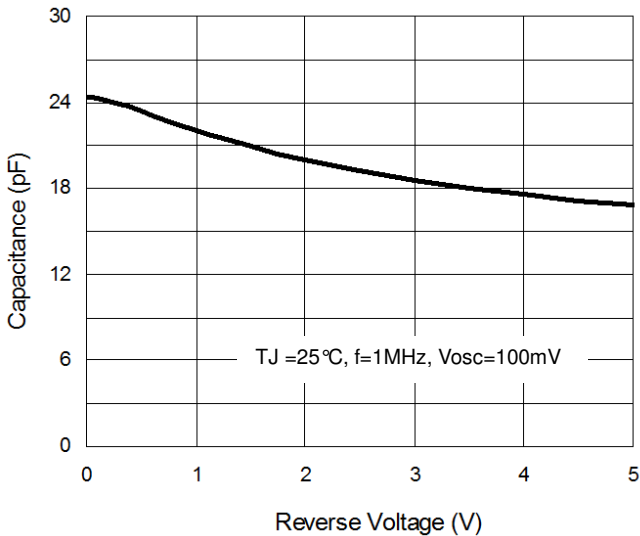

Figure 5. Typical Junction Capacitance

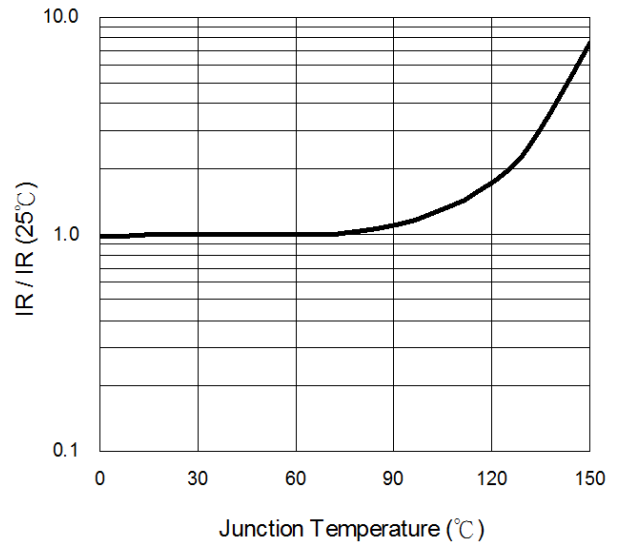

Figure 6. Reverse Leakage Current versus TJ

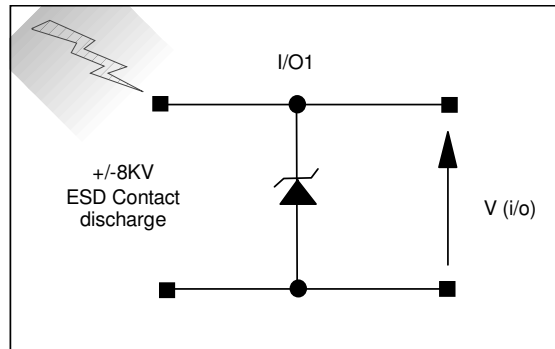

Figure 7. ESD Test Configuration

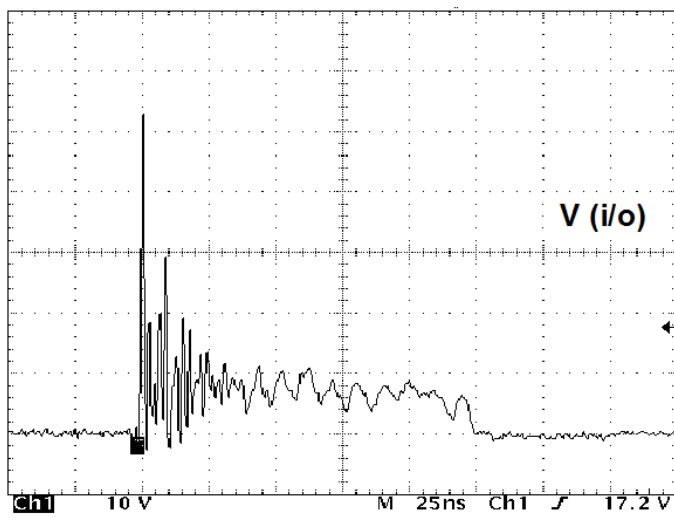

Figure 8. Clamped +8 kV ESD voltage waveform

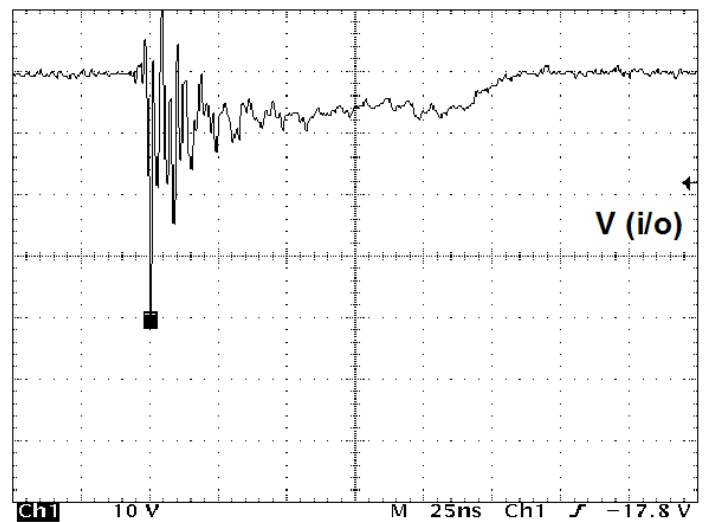
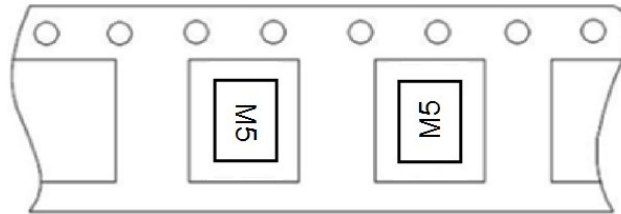

Figure 9. Clamped -8 kV ESD voltage waveform

MARKING AND PACKAGING INFORMATION
L13ESD5V0CE2



Marking and Orientation :



Note: Marking is none direction

Packaging Information :

DEVICE	Q'TY/REEL (PCS)	REEL DIA. (INCH)	Q'TY/BOX (PCS)	Q'TY/CARTON (PCS)
L13ESD5V0CE2	10K	7	150K	300K

SOD-882 Soldering Pad Layout :

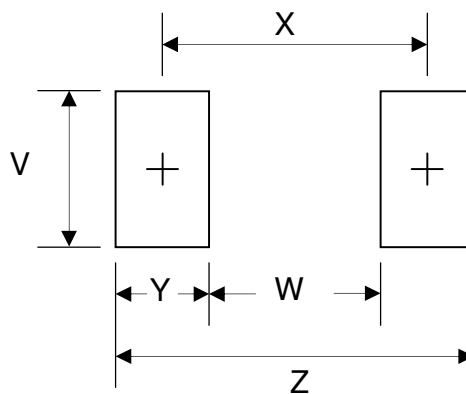

Dim.	Millimeters	Inches
Z	1.30	0.051
X	0.75	0.029
W	0.20	0.007
Y	0.55	0.021
V	0.80	0.031

Important Notice and Disclaimer

LSC reserves the right to make changes to this document and its products and specifications at any time without notice. Customers should obtain and confirm the latest product information and specifications before final design, purchase or use.

LSC makes no warranty, representation or guarantee regarding the suitability of its products for any particular purpose, nor does LSC assume any liability for application assistance or customer product design. LSC does not warrant or accept any liability with products which are purchased or used for any unintended or unauthorized application.

No license is granted by implication or otherwise under any intellectual property rights of LSC.

LSC products are not authorized for use as critical components in life support devices or systems without express written approval of LSC.