

VOLTAGE RANGE - 600 Volts

CURRENT - 2.0 Amperes

### FEATURES

- \* Low power loss, high efficiency
- \* Low leakage
- \* Low forward voltage drop
- \* High current capability
- \* High speed switching
- \* High surge capability
- \* High reliability

### MECHANICAL DATA

- \* Case: Molded plastic
- \* Epoxy: UL 94V-0 rate flame retardant
- \* Lead: MIL-STD-202E, Method 208 guaranteed
- \* Polarity: Color band denotes cathode end
- \* Mounting position: Any
- \* Weight: 0.4 gram

### MAXIMUM RATINGS AND ELECTRICAL CHARACTERISTICS

Ratings at 25 °C ambient temperature unless otherwise specified.  
Single phase, half wave, 60 Hz, resistive or inductive load.  
For capacitive load, derate current by 20%.

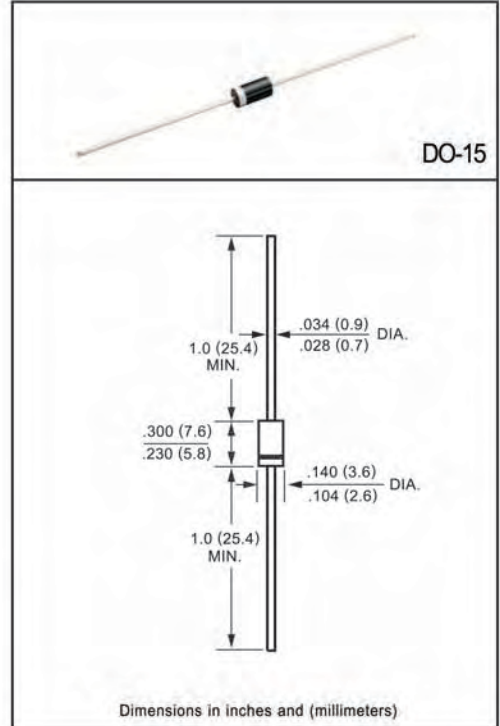

	SYMBOL	MUR 60	UNITS
Maximum Recurrent Peak Reverse Voltage	VRRM	600	Volts
Maximum RMS Voltage	VRMS	420	Volts
Maximum DC Blocking Voltage	VDC	600	Volts
Maximum Average Forward Rectified Current at TA= 50°C	Io	2.0	Amps
Peak Forward Surge Current 8.3 ms single half sine-wave superimposed on rated load (JEDEC Method)	IFSM	60	Amps
Maximum Instantaneous Forward Voltage at 2.0A DC	VF	1.7	Volts
Maximum DC Reverse Current at Rated DC Blocking Voltage TA = 25°C	IR	5.0	uAmps
Maximum Full Load Reverse Current Average, Full Cycle .375*(9.5mm) lead length at TL = 55°C		100	uAmps
Maximum Reverse Recovery Time (Note 1)	trr	75	nSec
Typical Junction Capacitance (Note 2)	CJ	20	pF
Operating and Storage Temperature Range	TJ, TSTG	-65 to +150	°C

NOTES : 1. Test Conditions: IF = 0.5A, IR = 1.0A, IRR = 0.25A  
2. Measured at 1 MHz and applied reverse voltage of 4.0 volts

PACKAGE	SPQ/PCS	CARTON SPQ/PCS	CARTON SIZE/CM	CARTON GW/KG	CARTON NW/KG
DO-15	3000/AMMO	30000	42X28X31	12.00	10.00

### RATING AND CHARACTERISTIC CURVES (MUR260)

FIG. 1 - TEST CIRCUIT DIAGRAM AND REVERSE RECOVERY TIME CHARACTERISTIC

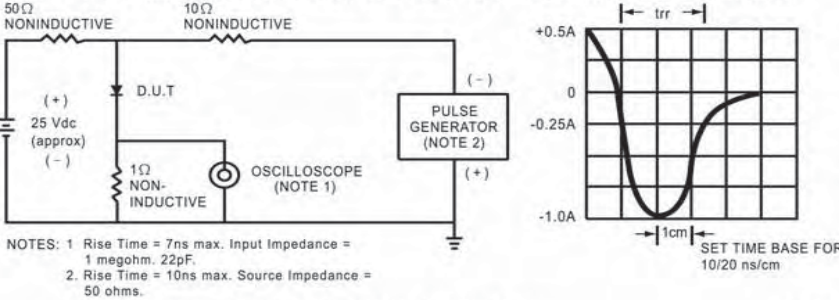

FIG. 2 - TYPICAL FORWARD CURRENT DERATING CURVE

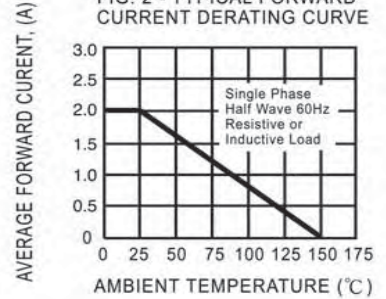

FIG. 3 - TYPICAL REVERSE CHARACTERISTICS

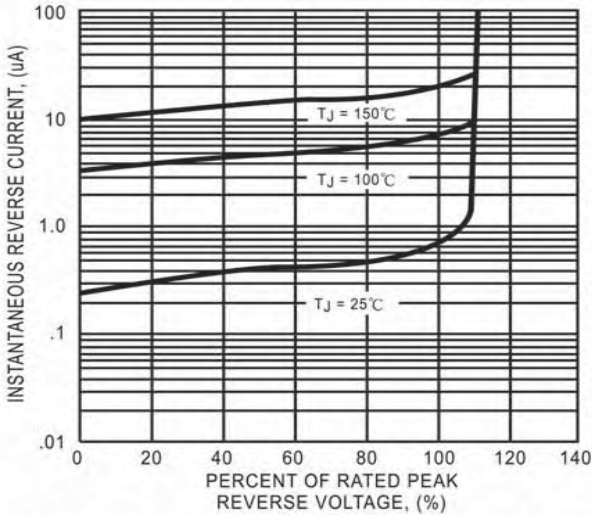

FIG. 4 - TYPICAL INSTANTANEOUS FORWARD CHARACTERISTICS

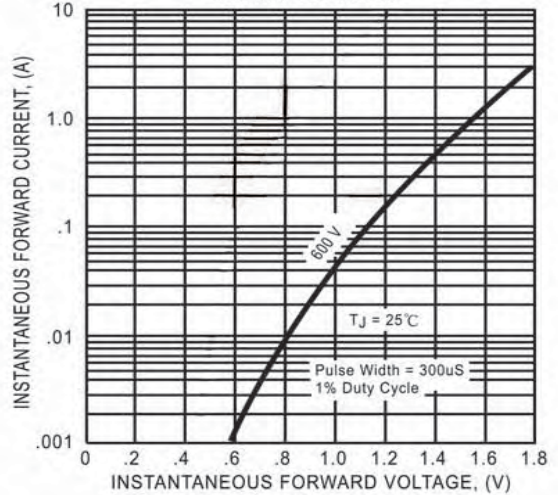

FIG. 5 - MAXIMUM NON-REPETITIVE FORWARD SURGE CURRENT

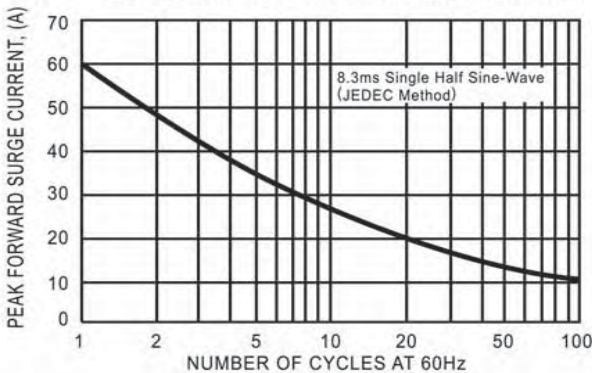
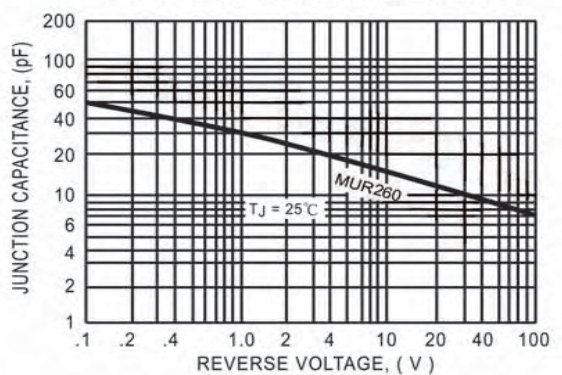

FIG. 6 - TYPICAL JUNCTION CAPACITANCE



PACKAGE	SPQ/PCS	CARTON SPQ/PCS	CARTON SIZE/CM	CARTON GW/KG	CARTON NW/KG
DO-15	3000/AMMO	30000	42X28X31	12.00	10.00