

Description

The AR3304P8 is a 3.3V uni-directional TVS diode array, utilizing leading monolithic silicon technology to provide fast response time and ultra low ESD clamping voltage, making this device an ideal solution for protecting voltage sensitive data and power line. The AR3304P8 complies with the IEC 61000-4-2 (ESD) with $\pm 30\text{kV}$ air and $\pm 30\text{kV}$ contact discharge. It is assembled into 2.6x2.6x0.55mm DFN lead-free package. The small size and high ESD surge protection make AR3304P8 an ideal choice to protect Gigabit Ethernet, telecommunication lines, and digital video.

Features

- Ultra low leakage: nA level
- Operating voltage: 3.3V
- Ultra low clamping voltage
- Complies with following standards:
 - IEC 61000-4-2 (ESD) immunity test
 - Air discharge: $\pm 30\text{kV}$
 - Contact discharge: $\pm 30\text{kV}$
 - IEC61000-4-5 (Lightning) 25A (8/20 μs)
- RoHS Compliant

Mechanical Characteristics

- Package: DFN2626-10
- Case Material: “Green” Molding Compound.
- Moisture Sensitivity: Level 3 per J-STD-020
- Terminal Connections: See Diagram Below
- Marking Information: See Below

Applications

- Analog Video
- RJ-45 Connectors
- T1/E1 Secondary Protection
- T3/E3 Secondary Protection
- 10/100/1000 Ethernet

Marking Information



3304 = Device Marking Code
 YYWW = Date Code
 Dot denotes Pin1

Ordering Information

Part Number	Packaging	Reel Size
AR3304P8	3000/Tape & Reel	7 inch

Dimensions and Pin Configuration

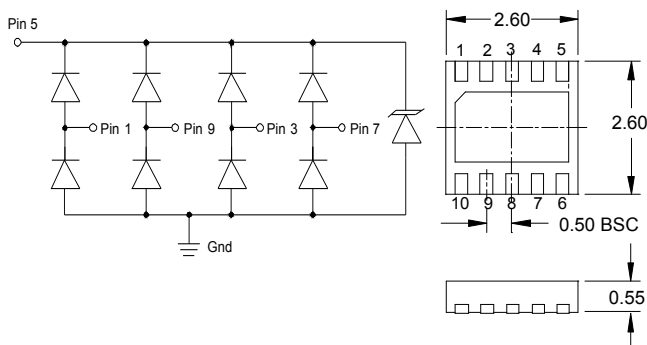

Circuit and Pin Schematic

Package Dimensions

Absolute Maximum Ratings ($T_A=25^{\circ}\text{C}$ unless otherwise specified)

Parameter	Symbol	Value	Unit
Peak Pulse Power (8/20 μs)	Ppk	450	W
Peak Pulse Current (8/20 μs)	Ipp	25	A
ESD per IEC 61000-4-2 (Air)	VESD	± 30	kV
ESD per IEC 61000-4-2 (Contact)		± 30	
Operating Temperature Range	TJ	-55 to +125	$^{\circ}\text{C}$
Storage Temperature Range	Tstg	-55 to +150	$^{\circ}\text{C}$

Electrical Characteristics ($T_A=25^{\circ}\text{C}$ unless otherwise specified)

Parameter	Symbol	Min	Typ	Max	Unit	Test Condition
Reverse Working Voltage	VRWM			3.3	V	
Punch-Through Voltage	VPT	3.5			V	IPT = 5 μA
Snap-Back Voltage	VSB	2.8			V	ISB = 50mA
Reverse Leakage Current	IR			0.5	μA	VRWM = 3.3V
Clamping Voltage	VC			5.5	V	I _{PP} = 1A (8 x 20 μs pulse), any I/O to GND
Clamping Voltage	VC			9.5	V	I _{PP} = 10A (8 x 20 μs pulse), any I/O to GND
Clamping Voltage	VC			18	V	I _{PP} = 25A (8 x 20 μs pulse), any I/O to GND
Junction Capacitance	CJ		2.0		pF	VR = 0V, f = 1MHz, between I/O pins
Junction Capacitance	CJ		3.2	5.0	pF	VR = 0V, f = 1MHz, any I/O to GND

Typical Performance Characteristics ($T_A=25^\circ\text{C}$ unless otherwise Specified)

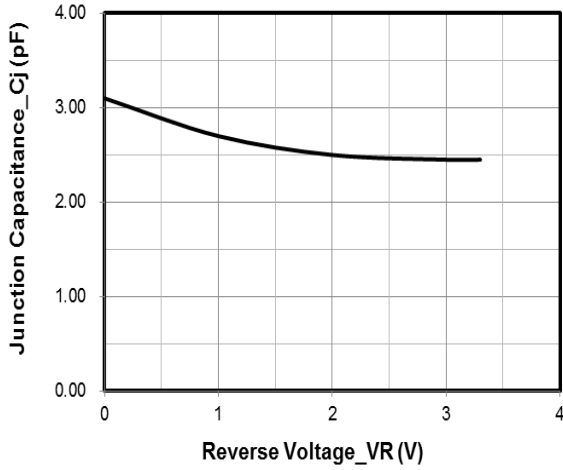

Junction Capacitance vs. Reverse Voltage

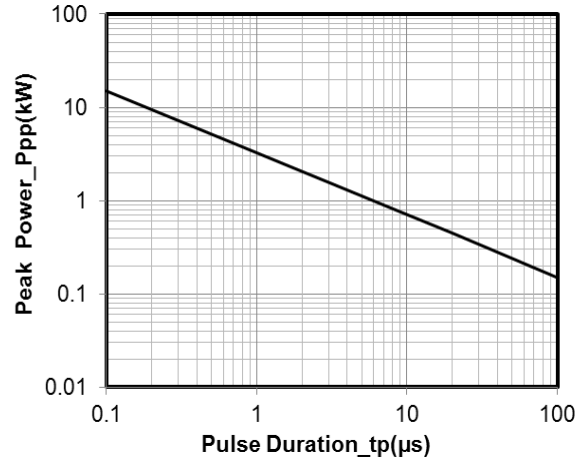

Peak Pulse Power vs. Pulse Time

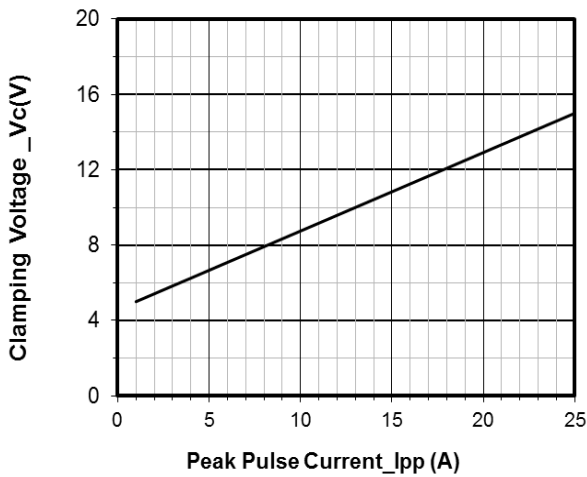

Clamping Voltage vs. Peak Pulse Current

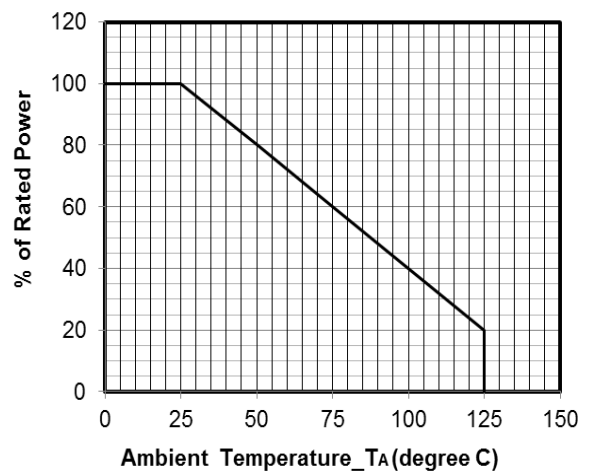

Power Derating Curve

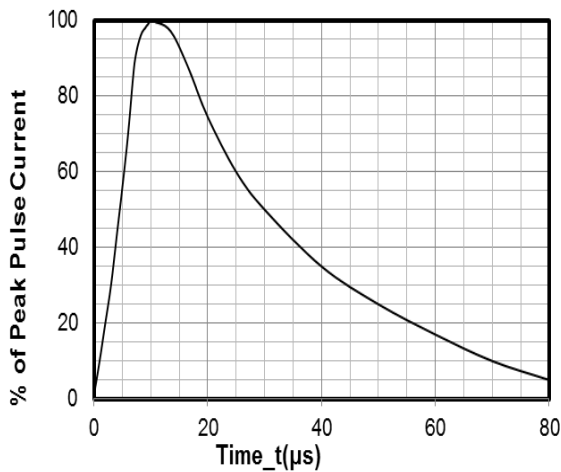

8 X 20 μs Pulse Waveform

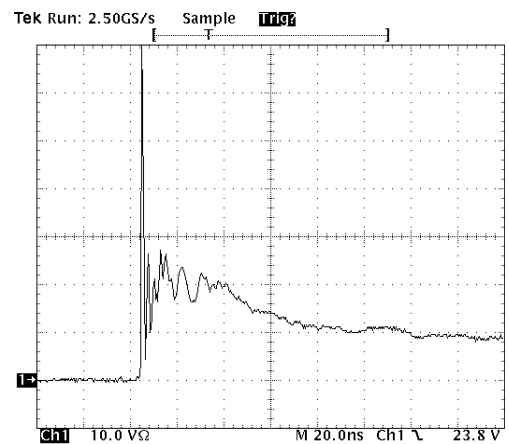

**Note: Data is taken with a 10x attenuator
ESD Clamping Voltage
8 kV Contact per IEC61000-4-2**

AR3304P8 on Gigabit Ethernet Protection

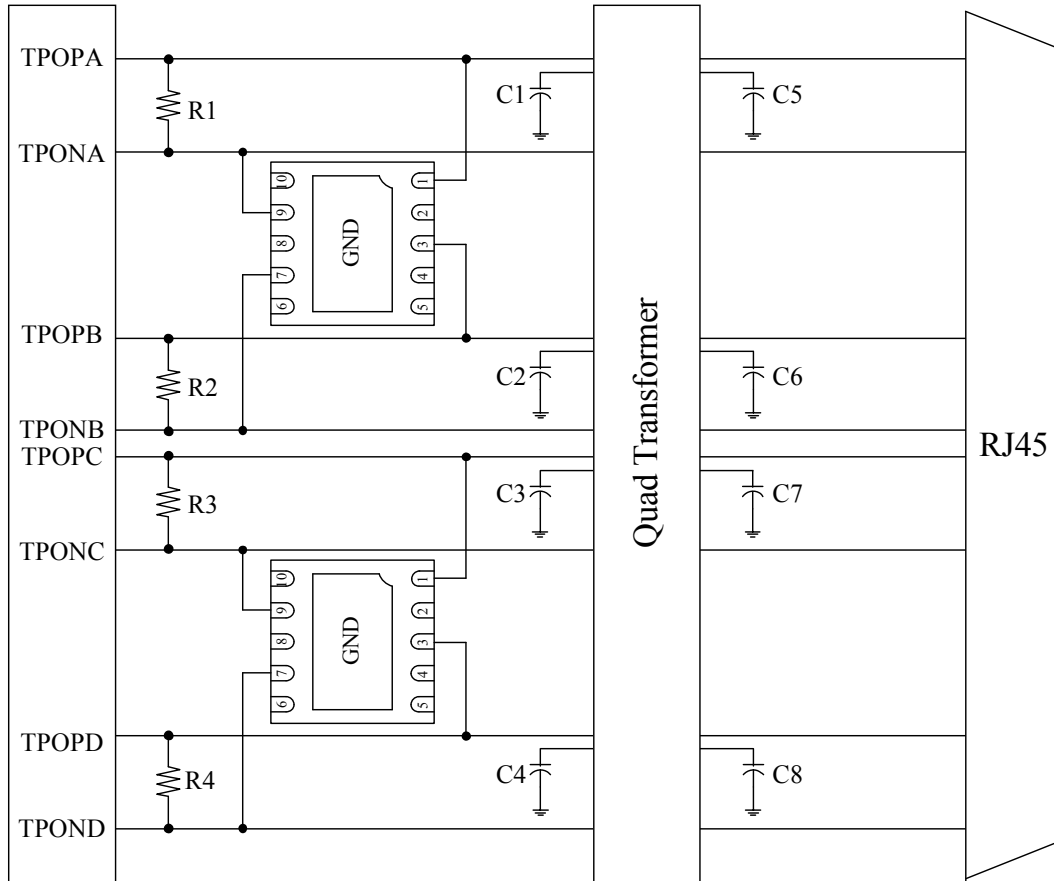

DFN2626-10 Package Outline Drawing

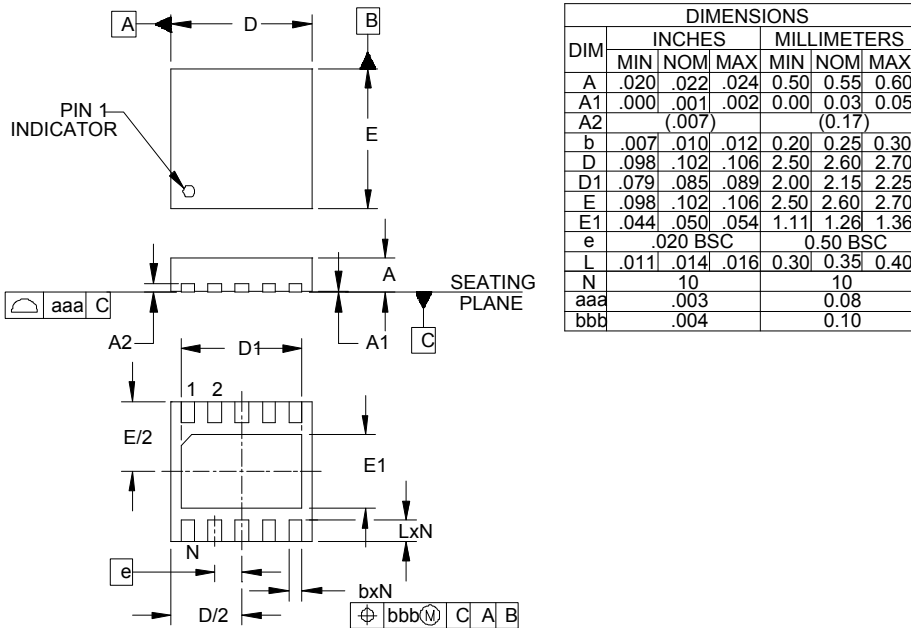

- NOTES:
1. CONTROLLING DIMENSIONS ARE IN MILLIMETERS (ANGLES IN DEGREES).
 2. COPLANARITY APPLIES TO THE EXPOSED PAD AS WELL AS THE TERMINALS.

Suggested Land Pattern

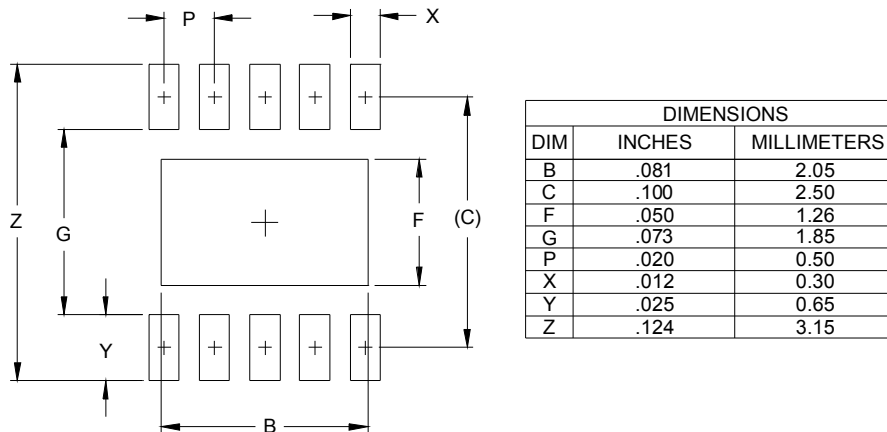

- NOTES:
1. THIS LAND PATTERN IS FOR REFERENCE PURPOSES ONLY. CONSULT YOUR MANUFACTURING GROUP TO ENSURE YOUR COMPANY'S MANUFACTURING GUIDELINES ARE MET.

Contact Information

Applied Power Microelectronics Co., Ltd.

Website: <http://www.appliedpowermicro.com>

Email: sales@appliedpowermicro.com

Phone: +86 (0519) 8399 3606