

DP1608 Series

Multilayer Chip Diplexers

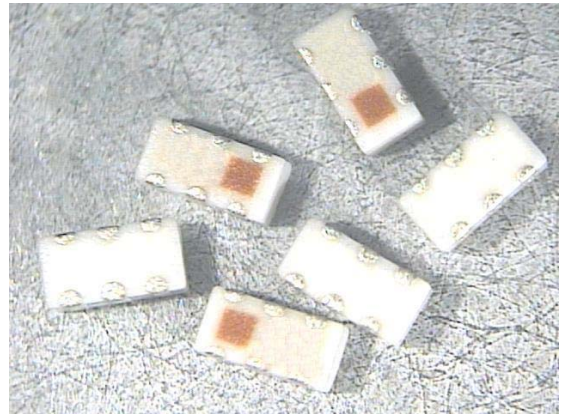

Features

- ❖ Monolithic structure including one low-pass and one high-pass filters with loss pole at adjacent passband.
- ❖ RoHS compliant
- ❖ Automobile grade & AEC-Q200 compliant

Applications

- ❖ Dual-band / dual-mode at 1.5GHz and 2.4GHz.

Specifications

Part Number	Passband (MHz)	Insertion Loss (dB)		Passband VSWR	Attenuation (dB)	Isolation (dB)
		max.	typ.			
DP1608-V1524AAA0_	1550~1580	0.6 max.	0.43 typ.	2.0 max.	12 min. @2400~2500MHz	20 min. @1550~1610MHz
	1594~1610	0.7 max.	0.55 typ.		12 min. @4900~6000MHz	
	2400~2500	0.7 max.	0.56 typ.	2.0 max.	20 min. @1550~1610MHz	12 min. @2400~2500MHz
	4900~6000	0.6 max.	0.42 typ.	2.0 max.		12 min. @4900~6000MHz

Q'ty/Reel (pcs) : 4,000
 Operating Temperature Range : -40 ~ +85 °C
 Storage Temperature Range : -40 ~ +85 °C
 Storage Period : 12 months max.
 Power Capacity : 3W max.

Part Number

DP 1608 - V 1524 AAA0 □ /LF
 ① ② ③ ④ ⑤ ⑥ ⑦

① Type	DP : Diplexer	② Dimensions (L × W)	1.6 × 0.8 mm
③ Material Code	V	④ Frequency Range	1524=1500MHz/2400MHz
⑤ Specification Code	AAA0	⑥ Packaging	T: Tape & Reel B: Bulk
⑦ Soldering	/LF=lead-free		

Terminal Configuration

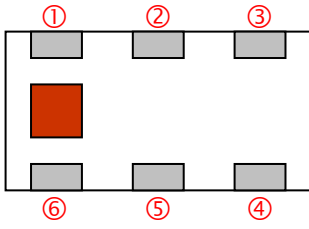

No.	Terminal Name	No.	Terminal Name
①	Lower Freq. Port	④	GND
②	GND	⑤	Common Port
③	Higher Freq. Port	⑥	GND

Dimensions and Recommended PC Board Pattern

Unit : mm

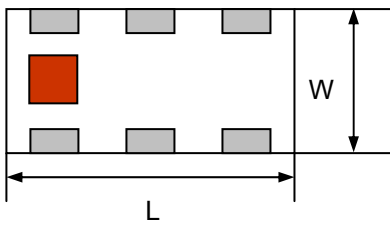

<Top View>

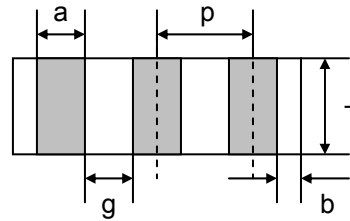

<Side View>

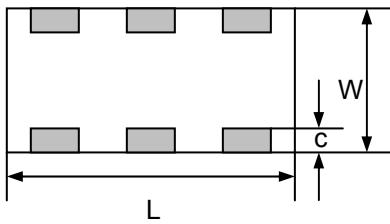

<Bottom View>

Mark	L	W	T	a	b	c	g	p
Dimensions	1.6 ±	0.8 ±	0.6 ±	0.2 ±	0.2+0.1	0.15 ±	0.3 ±	0.50 ±
	0.1	0.1	0.1	0.1	-0.15	0.1	0.1	0.05

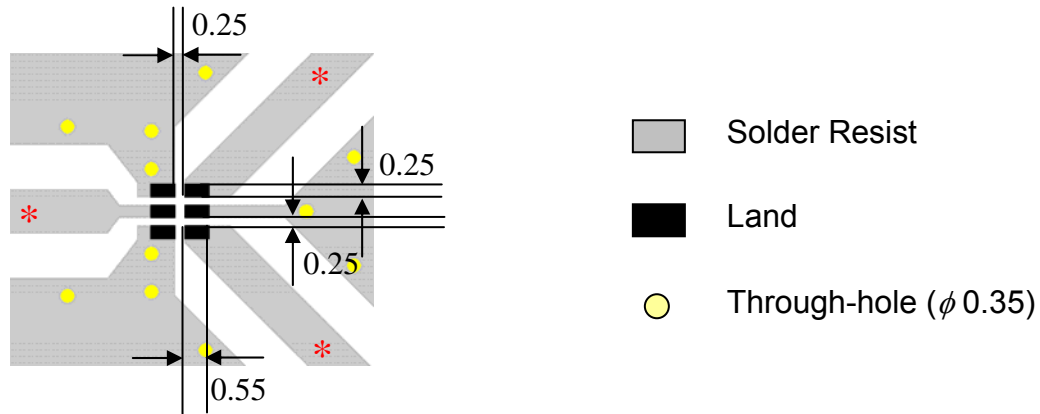

* Line width should be designed to match $50\ \Omega$ characteristic impedance, depending on PCB material and thickness.

Measuring Diagram

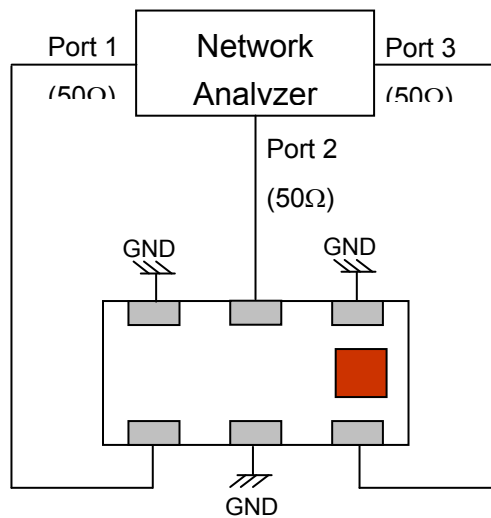

Typical Electrical Characteristics (T=25°C)

Attenuation

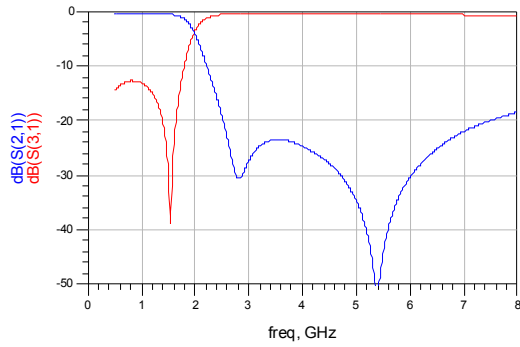

Return Loss

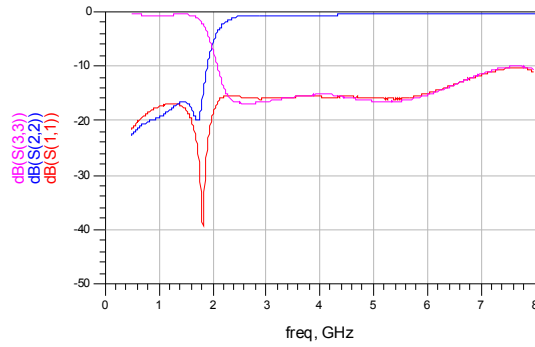

Isolation

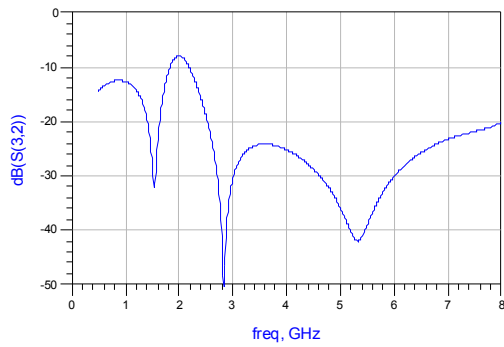

Notes

❖ The contents of this data sheet are subject to change without notice. Please confirm the specifications and delivery conditions when placing your order.

Taping Specifications

❖Tape Dimensions (Unit: mm) & Quantity

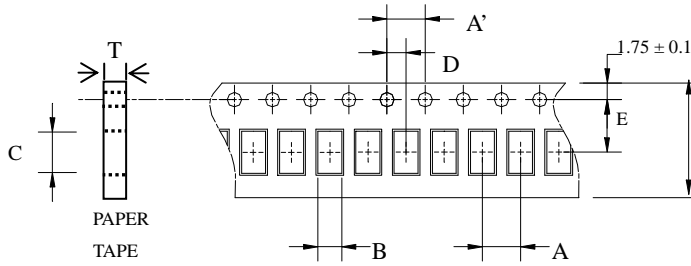

Type	A	A'	B	C	D	E	F	T	Quantity/reel	Tape material
1608	4.0±	4.0±	1.10±	1.92±	2.0±	3.5±	8.0±	0.75±	4,000pcs	Paper
	0.1	0.1	0.1	0.1	0.1	0.1	0.1	0.05		

❖Reel Dimensions (Unit: mm)

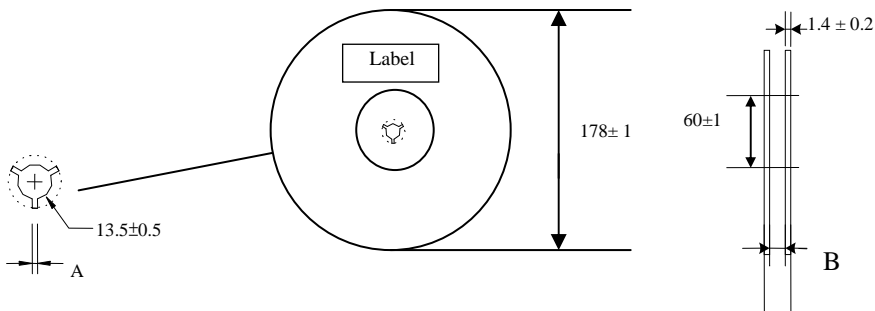

Label: Customer's Name,
ACX P/N, Q'ty, Date,
ACX Corp.

Type	A	B
1608	2.3±0.5	9.0±0.3

❖Leader and Trailer Tape

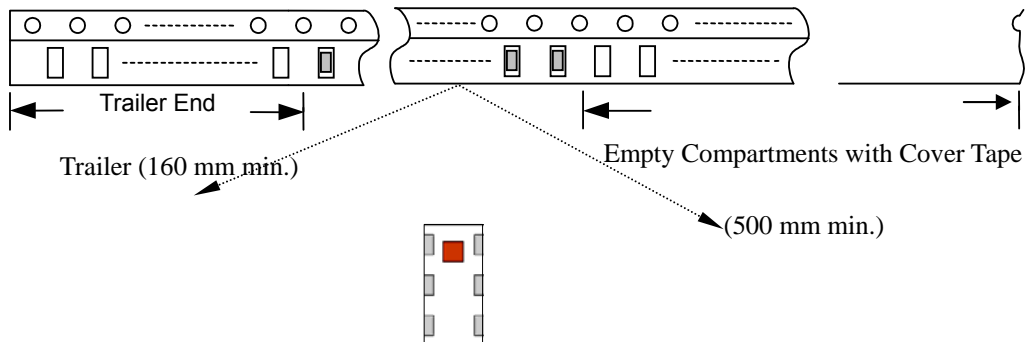

❖ **Peel-off Force**

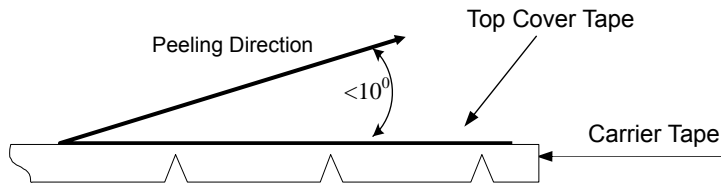

Peel-off force should be in the range of 0.1 – 0.6 N at a peel-off speed of 300 ± 10 mm/min .

❖ **Storage Conditions**

- (1) Temperature: 5 ~35°C , relative humidity (RH): 45~75%.
- (2) Non-corrosive environment.

Notes

- ❖ The contents of this data sheet are subject to change without notice. Please confirm the specifications and delivery conditions when placing your order.

Mechanical & Environmental Characteristics

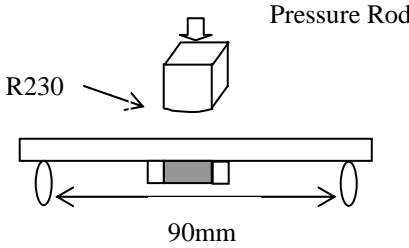
Item	Requirements	Procedure
Solderability	<ol style="list-style-type: none"> No apparent damage More than 95% of the terminal electrode shall be covered with new solder 	<ol style="list-style-type: none"> Preheat: $120 \pm 5^\circ\text{C}$ Solder: $245 \pm 5^\circ\text{C}$ for 5 ± 1 sec
Soldering strength (Termination Adhesion)	<ol style="list-style-type: none"> 1kg minimum 	<ol style="list-style-type: none"> Solder specimen onto test jig. Apply push force at 0.5mm/s until electrode pads are peeled off or ceramic are broken. Pushing force is applied to longitude direction.
Deflection (Substrate Bending)	<ol style="list-style-type: none"> No apparent damage 	<ol style="list-style-type: none"> Solder specimen onto test jig (FR4, 0.8mm) using the recommend soldering profile. Apply a bending force of 2mm deflection. 
Heat/Humidity Resistance	<ol style="list-style-type: none"> No apparent damage Fulfill the electrical specification after test 	<ol style="list-style-type: none"> Temperature: $85 \pm 2^\circ\text{C}$ Humidity: 90% ~ 95% RH Duration: 1000 ± 48hrs Recovery: 1-2hrs
Thermal shock (Temperature Cycle)	<ol style="list-style-type: none"> No apparent damage Fulfill the electrical specification after test 	<ol style="list-style-type: none"> One cycle/step 1 : $125 \pm 5^\circ\text{C}$ for 30 min step 2 : $-40 \pm 5^\circ\text{C}$ for 30 min No of cycles : 100 Recovery: 1-2 hrs
Low Temperature Resistance	<ol style="list-style-type: none"> No apparent damage Fulfill the electrical specification after test 	<ol style="list-style-type: none"> Temperature: $-40 \pm 5^\circ\text{C}$ Duration: 500 ± 24hrs Recovery: 1-2hrs

Soldering Conditions

❖ Typical Soldering Profile for Lead-free Process

Reflow Soldering :

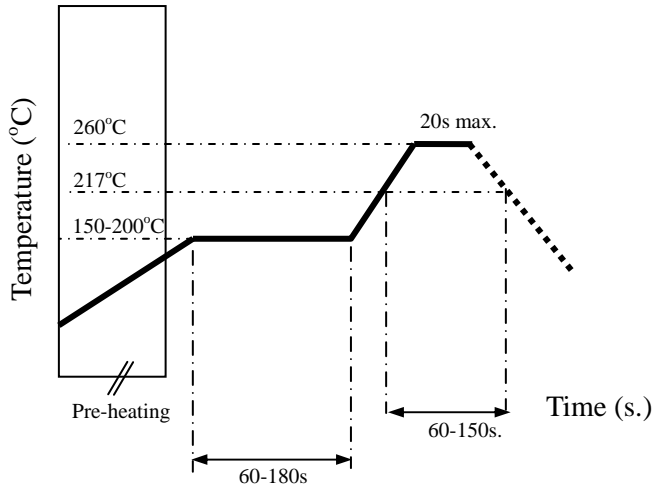

Notes

- ❖ The contents of this data sheet are subject to change without notice. Please confirm the specifications and delivery conditions when placing your order.

Advanced Ceramic X Corp.

16 Tzu Chiang Road, Hsinchu Industrial District Hsinchu Hsien 303, Taiwan

TEL:886-3-5987008 FAX:886-3-5987001

E-mail: acx@acxc.com.tw

<http://www.acxc.com.tw>