

»Features

- 240Watts peak pulse power ($t_p = 8/20\mu s$)
- Low clamping voltage
- Low leakage current
- Protection one power line
- Low Capacitance: 1.0 pF Typical
- IEC 61000-4-2 $\pm 30kV$ contact $\pm 30kV$ air
- IEC 61000-4-4 (EFT) 40A (5/50ns)
- IEC 61000-4-5 (Lightning) 6A (8/20 μs)

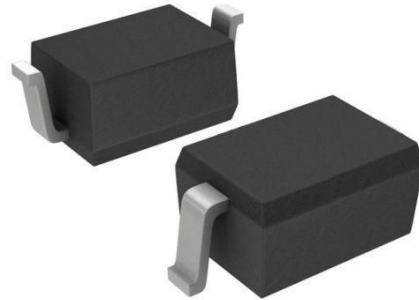

»Applications

- Ethernet - 10/100/1000 Base T
- Cellular Phones
- Handheld - Wireless Systems
- Personal Digital Assistant (PDA)
- USB Interface

»Mechanical Data

- SOD-323 package
- Molding compound flammability rating: UL94V-0
- Packaging: Tape and Reel
- RoHS/WEEE Compliant

»Schematic & PIN Configuration

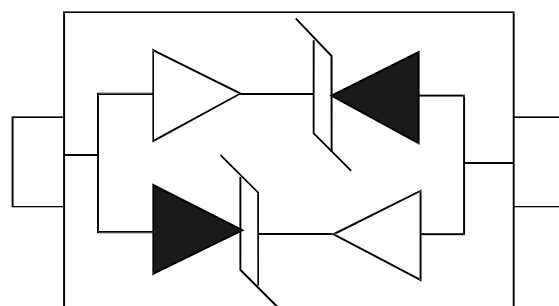

SOD-323

»Absolute Maximum Rating

Rating	Symbol	Value	Units
Peak Pulse Power ($t_p = 8/20\mu s$)	P_{PP}	240	Watts
Peak Pulse Current ($t_p = 8/20\mu s$) (note1)	I_{pp}	6	A
ESD per IEC 61000-4-2 (Air) ESD per IEC 61000-4-2 (Contact)	V_{ESD}	30 30	kV
Lead Soldering Temperature	T_L	260(10seconds)	°C
Junction Temperature	T_J	-55 to + 150	°C
Storage Temperature	T_{stg}	-55 to + 150	°C

»Electrical Characteristics

Parameter	Symbol	Conditions	Min	Typical	Max	Units
Reverse Stand-Off Voltage	V_{RWM}				15.0	V
Reverse Breakdown Voltage	V_{BR}	$I_T = 1mA$	16.7			V
Reverse Leakage Current	I_R	$V_{RWM} = 15V, T = 25^\circ C$			1	μA
Clamping Voltage	V_C	$I_{PP} = 6A, t_p = 8/20\mu s$		40		V
Junction Capacitance	C_j	$V_R = 0V, f = 1MHz$		1.0	1.5	pF

»Electrical Parameters (TA = 25°C unless otherwise noted)

Symbol	Parameter
I_{PP}	Maximum Reverse Peak Pulse Current
V_C	Clamping Voltage @ I_{PP}
V_{RWM}	Working Peak Reverse Voltage
I_R	Maximum Reverse Leakage Current @ V_{RWM}
V_{BR}	Breakdown Voltage @ I_T
I_T	Test Current

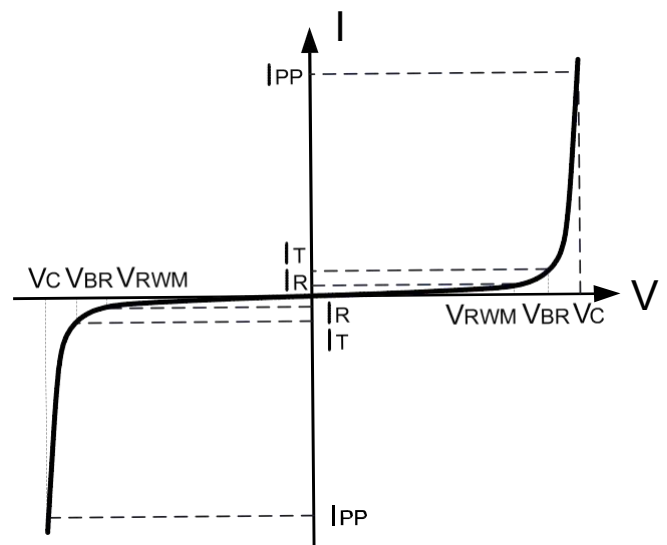

Figure 1: Peak Pulse Power vs. Pulse Time

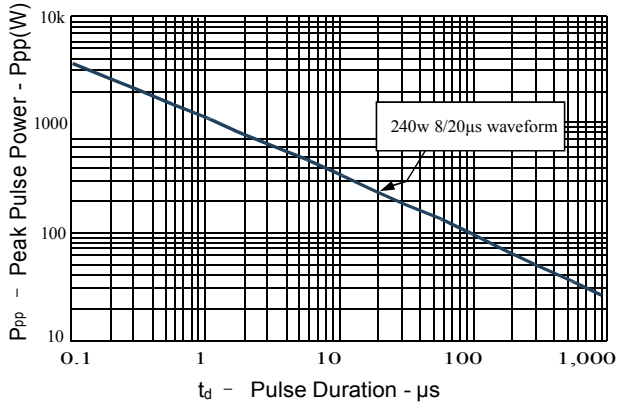

Figure 2: Power Derating Curve

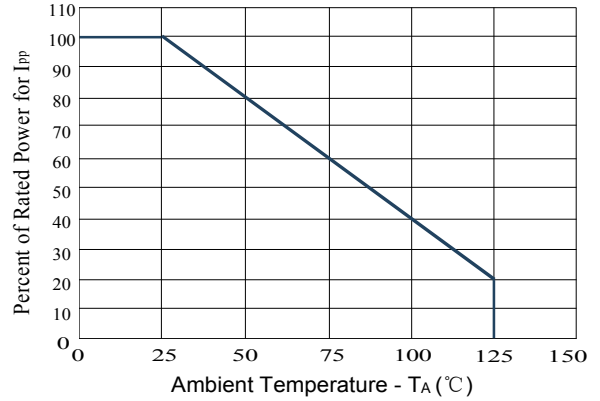

Figure3: Pulse Waveform

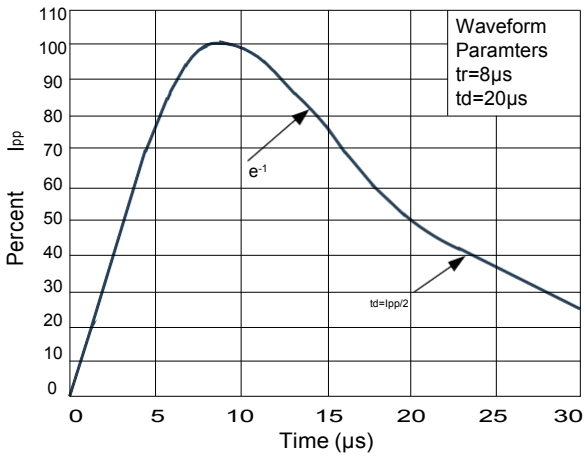
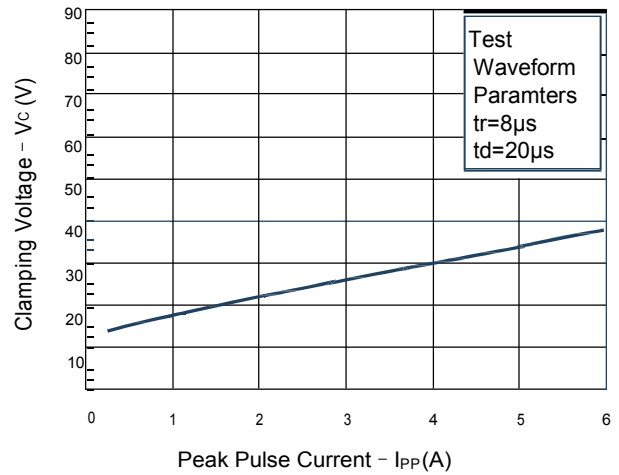
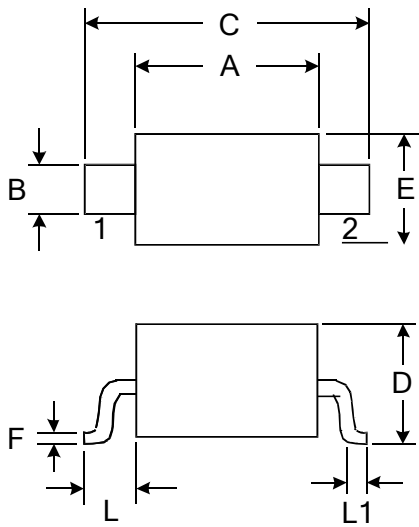

Figure 4: Clamping Voltage vs. Ipp



»Outline Drawing – SOD323



DIMENSIONS				
SYMBOL	MILLIMETER		INCHES	
	MIN	MAX	MIN	MAX
A	1.600	1.800	0.063	0.071
B	0.250	0.350	0.010	0.014
C	2.500	2.700	0.098	0.106
D		1.000		0.039
E	1.200	1.400	0.047	0.055
F	0.080	0.150	0.003	0.006
L	0.475 REF		0.019REF	
L1	0.250	0.400	0.010	0.016
H	0.000	0.100	0.000	0.004

»Marking

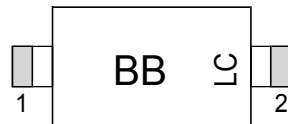

Pin Style: 1. Cathode 2. Anode

»Ordering information

Order code	Package	Base qty	Delivery mode
GBLC15C-N	SOD323	3000	Tape and reel