

PIN Connection TO-220F

Switching Regulator Application

Features

- High Voltage : $BV_{DSS}=650V(\text{Min.})$
- Low C_{rss} : $C_{rss}=14.6pF(\text{Typ.})$
- Low gate charge : $Q_g=41nC(\text{Typ.})$
- Low $R_{DS(on)}$: $R_{DS(on)}=0.65\Omega(\text{Max.})$

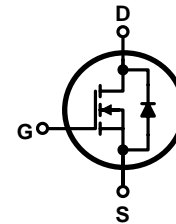
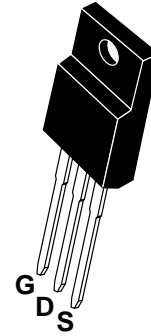

Marking Diagram



- Y = Year
- A = Assembly Location
- WW = Work Week
- FIR12N65F = Specific Device Code

Absolute maximum ratings ($T_C=25^\circ\text{C}$ unless otherwise noted)

Characteristic	Symbol	Rating	Unit	
Drain-source voltage	V_{DSS}	650	V	
Gate-source voltage	V_{GSS}	± 30	V	
Drain current (DC) *	I_D	$T_C=25^\circ\text{C}$	12	A
		$T_C=100^\circ\text{C}$	9.0	A
Drain current (Pulsed) *	I_{DM}	48	A	
Power dissipation	P_D	51	W	
Avalanche current (Single) ②	I_{AS}	12	A	
Single pulsed avalanche energy ②	E_{AS}	790	mJ	
Avalanche current (Repetitive) ①	I_{AR}	12	A	
Repetitive avalanche energy ①	E_{AR}	7.6	mJ	
Junction temperature	T_J	150	$^\circ\text{C}$	
Storage temperature range	T_{stg}	-55~150		

* Limited by maximum junction temperature

Characteristic		Symbol	Typ.	Max.	Unit
Thermal resistance	Junction-case	$R_{th(J-C)}$	-	2.6	$^\circ\text{C}/\text{W}$
	Junction-ambient	$R_{th(J-A)}$	-	120	

Electrical Characteristics ($T_C=25^\circ\text{C}$ unless otherwise noted)

Characteristic	Symbol	Test Condition	Min.	Typ.	Max.	Unit	
Drain-source breakdown voltage	BV_{DSS}	$I_D=250\mu\text{A}, V_{GS}=0\text{V}$	650	-	-	V	
Gate threshold voltage	$V_{GS(th)}$	$I_D=250\mu\text{A}, V_{DS}=V_{GS}$	2.0	-	4.0	V	
Drain-source cut-off current	I_{DSS}	$V_{DS}=650\text{V}, V_{GS}=0\text{V}$	-	-	1	μA	
Gate leakage current	I_{GSS}	$V_{DS}=0\text{V}, V_{GS}=\pm 30\text{V}$	-	-	± 100	nA	
Drain-source on-resistance ④	$R_{DS(on)}$	$V_{GS}=10\text{V}, I_D=6.0\text{A}$	-	0.65	0.80	Ω	
Forward transfer conductance ④	g_{fs}	$V_{DS}=10\text{V}, I_D=6.0\text{A}$	-	10	-	S	
Input capacitance	C_{iss}	$V_{GS}=0\text{V}, V_{DS}=25\text{V}$ $f=1\text{ MHz}$	-	1476	-	pF	
Output capacitance	C_{oss}		-	152	-		
Reverse transfer capacitance	C_{rss}		-	4.5	-		
Turn-on delay time	$t_{d(on)}$	$V_{DD}=300\text{V}, I_D=12\text{A}$ $R_G=25\Omega$	-	37	-	ns	
Rise time	t_r		-	62	-		
Turn-off delay time	$t_{d(off)}$		③④	-	47		-
Fall time	t_f		-	90	-		
Total gate charge	Q_g	$V_{DS}=520\text{V}, V_{GS}=10\text{V}$ $I_D=12\text{A}$	-	24	-	nC	
Gate-source charge	Q_{gs}		③④	-	8		-
Gate-drain charge	Q_{gd}		-	7.5	-		

Source-Drain Diode Ratings and Characteristics ($T_C=25^\circ\text{C}$ unless otherwise noted)

Characteristic	Symbol	Test Condition	Min.	Typ.	Max.	Unit
Source current (DC)	I_S	Integral reverse diode in the MOSFET	-	-	12	A
Source current (Pulsed) ①	I_{SM}		-	-	48	
Forward voltage ④	V_{SD}	$V_{GS}=0\text{V}, I_S=12\text{A}$	-	-	1.4	V
Reverse recovery time	t_{rr}	$I_S=12\text{A}, V_{GS}=0\text{V}$ $dI_F/dt=100\text{A}/\mu\text{s}$	-	600	-	ns
Reverse recovery charge	Q_{rr}		-	5.7	-	μC

Note ;

- ① Repetitive rating : Pulse width limited by maximum junction temperature
- ② $L=1.8\text{mH}, I_{AS}=6.6\text{A}, V_{DD}=140\text{V}, R_G=25\Omega$, Starting $T_J=25^\circ\text{C}$
- ③ Pulse Test : Pulse width $\leq 300\mu\text{s}$, Duty cycle $\leq 2\%$
- ④ Essentially independent of operating temperature

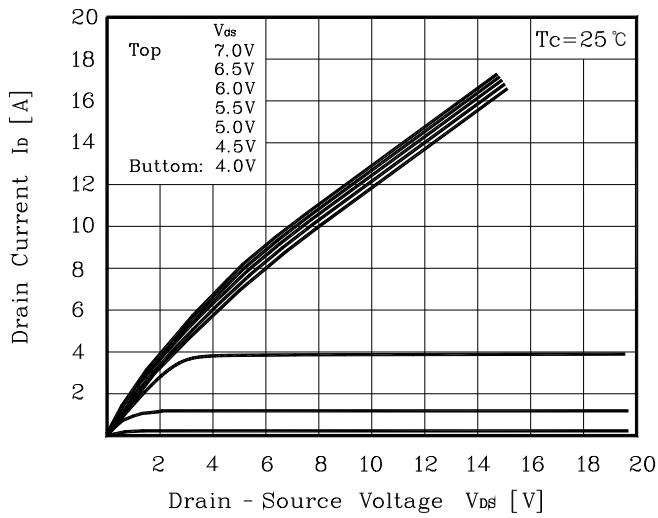
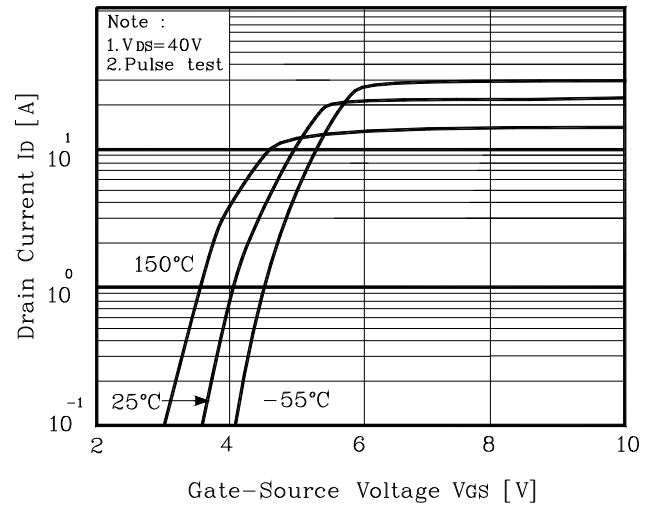
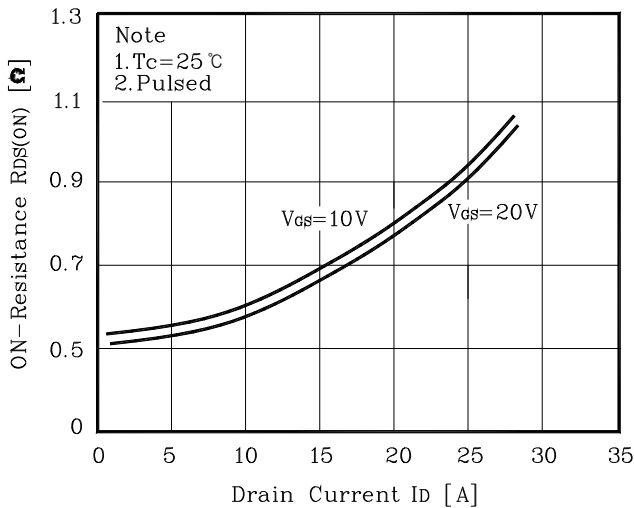
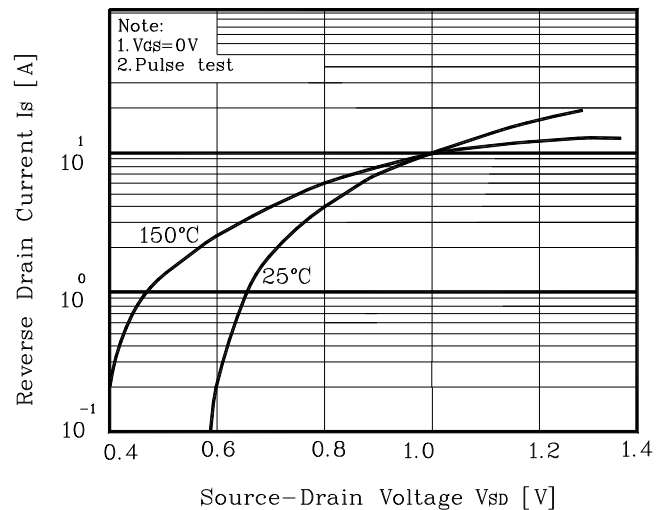
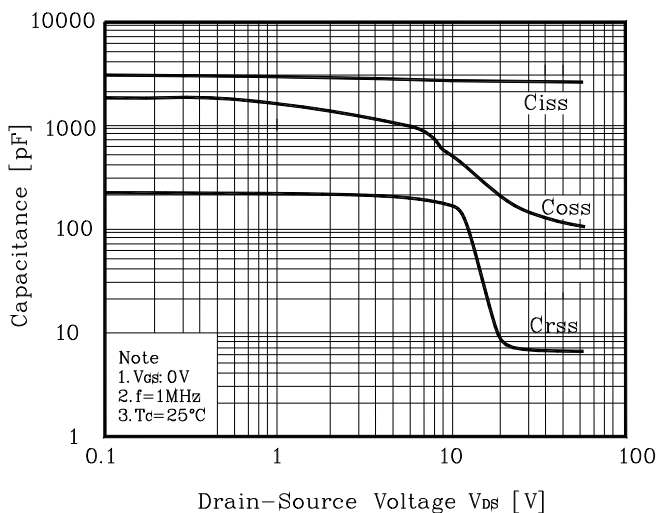
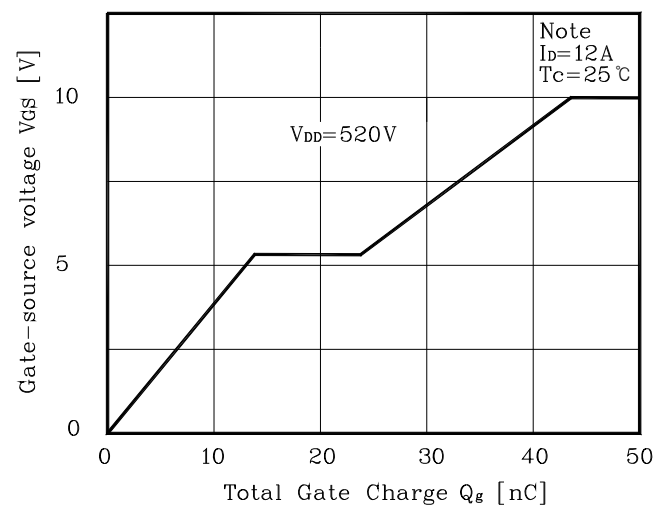
Electrical Characteristic Curves
Fig. 1 $I_D - V_{DS}$

Fig. 2 $I_D - V_{GS}$

Fig. 3 $R_{DS(on)} - I_D$

Fig. 4 $I_S - V_{SD}$

Fig. 5 Capacitance - V_{DS}

Fig. 6 $V_{GS} - Q_G$

Electrical Characteristic Curves

Fig. 7 $V_{DSS} - T_J$

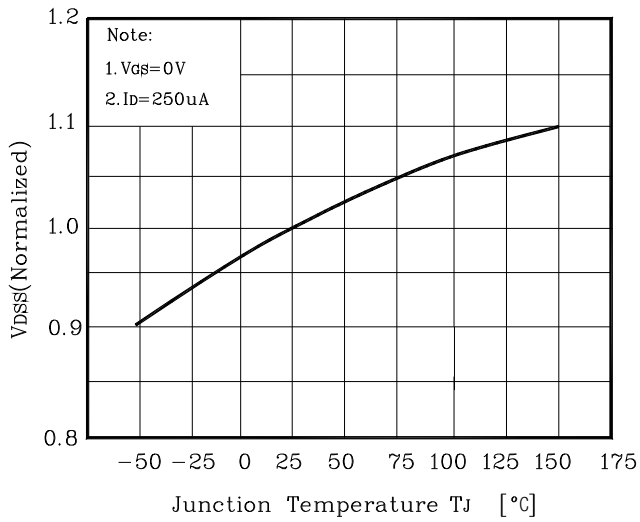

Fig.8 $R_{DS(on)} - T_J$

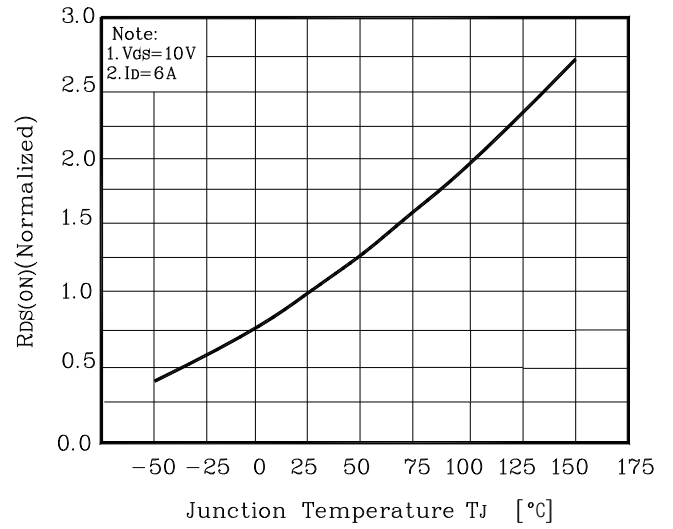

Fig. 9 $I_D - T_C$

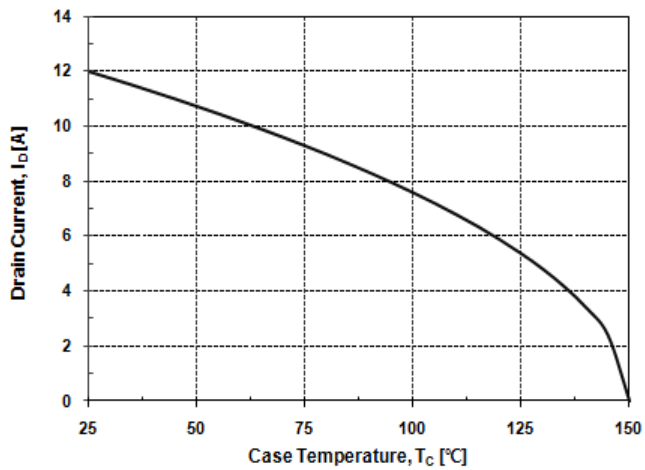

Fig. 10 Safe Operating Area

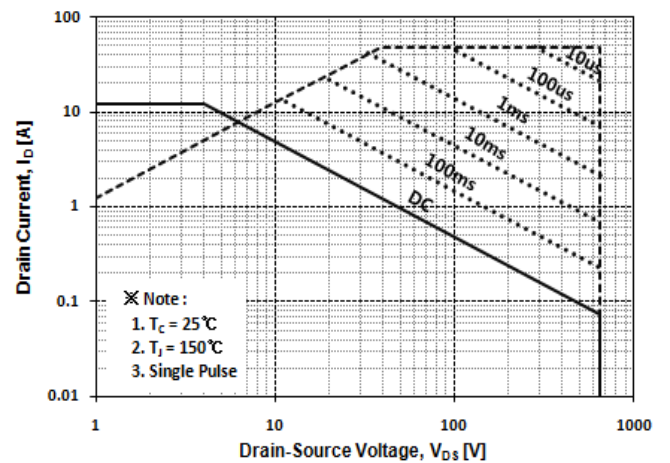

Fig. 11 Gate Charge Test Circuit & Waveform

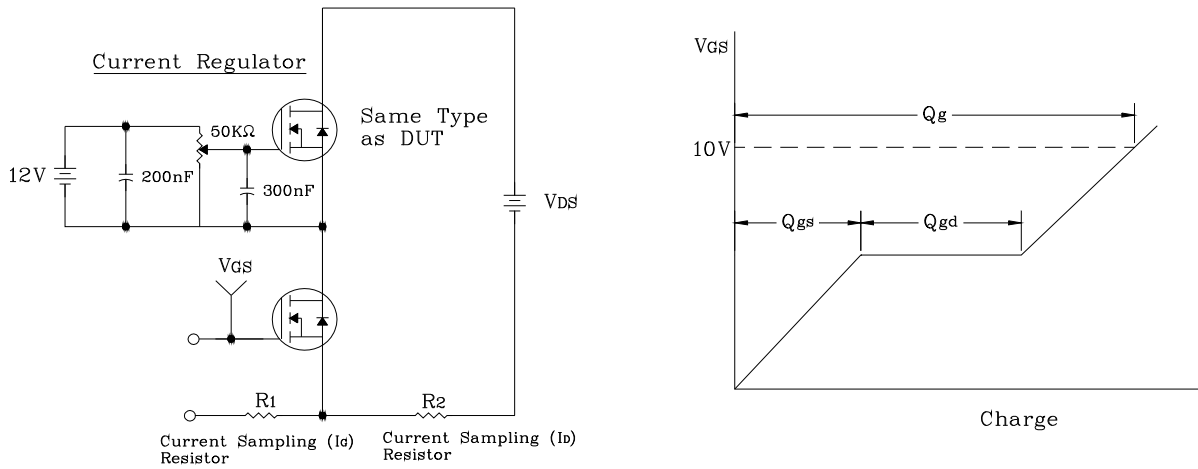

Fig. 12 Resistive Switching Test Circuit & Waveform

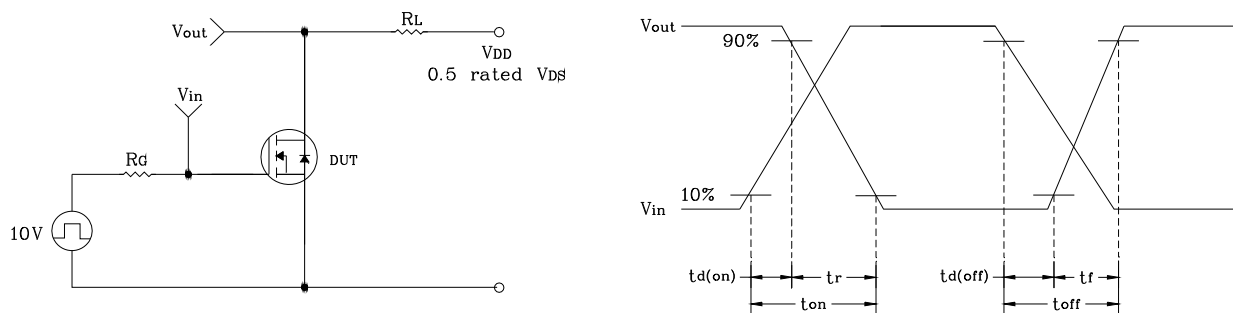

Fig. 13 E_{AS} Test Circuit & Waveform

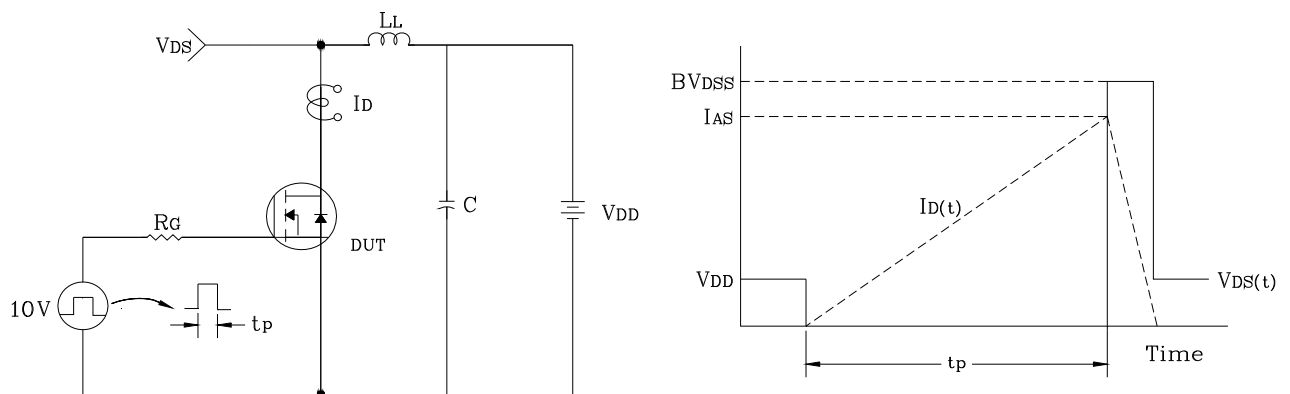
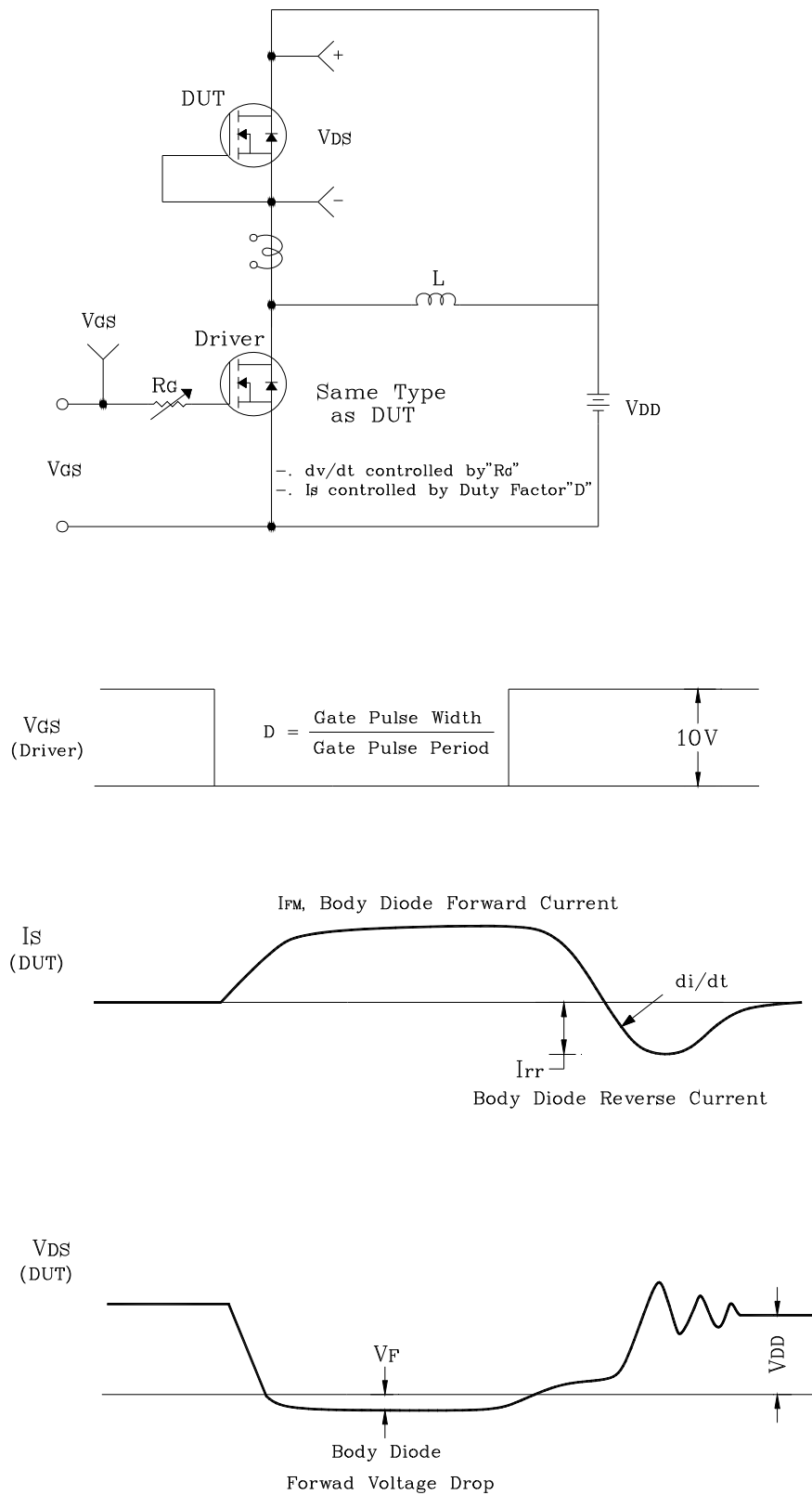
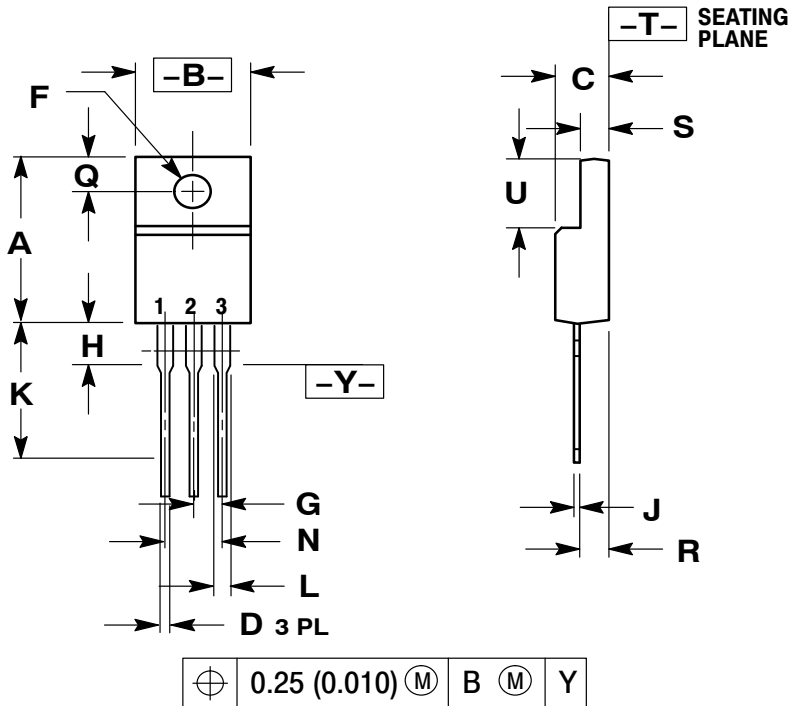

Fig. 14 Diode Reverse Recovery Time Test Circuit & Waveform

Package Dimensions

TO-220F



NOTES:

1. DIMENSIONING AND TOLERANCING PER ANSI Y14.5M, 1982.
2. CONTROLLING DIMENSION: INCH
3. 221D-01 THRU 221D-02 OBSOLETE, NEW STANDARD 221D-03.

DIM	INCHES		MILLIMETERS	
	MIN	MAX	MIN	MAX
A	0.617	0.635	15.67	16.12
B	0.392	0.419	9.96	10.63
C	0.177	0.193	4.50	4.90
D	0.024	0.039	0.60	1.00
F	0.116	0.129	2.95	3.28
G	0.100 BSC		2.54 BSC	
H	0.118	0.135	3.00	3.43
J	0.018	0.025	0.45	0.63
K	0.503	0.541	12.78	13.73
L	0.048	0.058	1.23	1.47
N	0.200 BSC		5.08 BSC	
Q	0.122	0.138	3.10	3.50
R	0.099	0.117	2.51	2.96
S	0.092	0.113	2.34	2.87
U	0.239	0.271	6.06	6.88