

## Powder Molding Type

### BCIHP0712/15/18/24/30/50-Series

- Photograph picture



BCIHP0712/15/18/24/30/50

- Dimensions

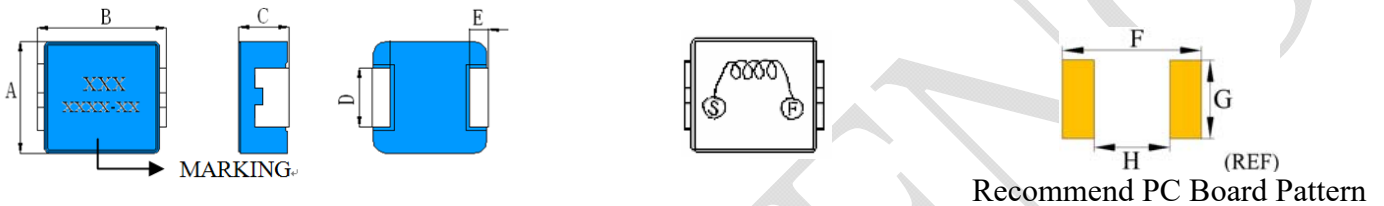

ITEM	A(mm)	B(mm)	C(mm)	D(mm)	E(mm)	F(mm)	G(mm)	H(mm)
BCIHP0712-Series	6.60±0.2	7.00±0.3	1.2MAX	3.00±0.3	1.60±0.3	7.55	3.35	2.40
BCIHP0715-Series	6.60±0.2	7.00±0.3	1.5MAX	3.00±0.3	1.60±0.3	7.55	3.35	2.40
BCIHP0718-Series	6.60±0.2	7.00±0.3	1.8MAX	3.00±0.3	1.60±0.3	7.55	3.35	2.40
BCIHP0724-Series	6.60±0.2	7.00±0.3	2.4MAX	3.00±0.3	1.60±0.3	7.55	3.35	2.40
BCIHP0730-Series	6.60±0.2	7.00±0.3	3.0MAX	3.00±0.3	1.60±0.3	7.55	3.35	2.40
BCIHP0750-Series	6.60±0.2	7.00±0.3	5.0MAX	3.00±0.3	1.60±0.3	7.55	3.35	2.40

- Part Numbering

BCIHP    0712    -    4R7    M  
 A                  B                  C                  D

A:Series(系列代號)

B:Dimension(尺寸)                                                  B×C

C: Inductance(電感值)                                                  4R7=4.7uH

D:Inductance Tolerance(電感值公差)    M=±20%

- Features

1. Compliance with RoHs.
2. Lowest DCR.
3. Frequency range up to 5.0MHz.
4. Handles high transient current spikes without saturation
5. Ultra low buzz noise, due to composite construction.

- Applications

1. DC/DC converter for CPU in Notebook PC
2. Battery powered devices
3. Cellular phones LCD displays, HDDs, DVCs, DSCs, PDA etc.
4. Thin type on-board power supply module.

- 特點

1. 符合 RoHs.
2. 低電阻.
3. 頻率可達到 5.0 MHz.
4. 可處理在未飽和時的高瞬間電流.
5. 設計緊湊/超低噪音

- 應用

1. 用於筆記本電腦處理器的 DC/DC 轉換設備.
2. 電源,電池設備.
3. 適用於手機液晶屏顯示,HDD, DVC, DSC, PDA 等.
4. 薄型車載電源模組.

## Powder Molding Type

### BCIHP0712/15/18/24/30/50-Series

- Specification

ITEM	INDUCTANCE uH @200KHZ,0.25V,0A(1)	DCR mΩ 25°C MAX.	DCR mΩ 25°C Typ.	HEAT RATING CURRENT DC AMPS ( <sup>5</sup> ) TYPICAL(Irms)	SATURATION CURRENT DC AMPS ( <sup>6</sup> ) TYPICAL(Isat)
BCIHP0712-3R3M	3.30	105.00	113.00	3.00	3.60
BCIHP0712-4R7M	4.70	185.00	165.00	2.40	2.80
BCIHP0712-6R8M	6.80	217.00	208.00	2.10	2.40
BCIHP0712-100M	10.00	310.00	270.00	2.00	2.20
BCIHP0715-1R0M	1.00	25.80	22.80	6.50	12.00
BCIHP0715-2R2M <sup>[8]</sup>	2.20	55.00	48.50	4.50	6.50
BCIHP0715-2R5M	2.50	68.00	58.00	4.30	6.00
BCIHP0715-3R3M <sup>[8]</sup>	3.30	80.00	73.00	2.00	5.50
BCIHP0715-4R7M	4.70	113.00	105.00	3.20	5.00
BCIHP0715-6R8M	6.80	217.00	205.00	2.40	3.50
BCIHP0715-100M	10.00	200.00 <sup>[8]</sup>	188.5 <sup>[8]</sup>	2.00	2.50
BCIHP0718-R33M IHL P-2525AH-01	0.33	7.00	5.50	12.00	18.00
BCIHP0718-R47M IHL P-2525AH-01	0.47	9.30	7.00	11.00	18.00
BCIHP0718-R68M	0.68	13.90	10.30	9.00	15.00
BCIHP0718-R82M	0.82	15.90	13.70	8.00	14.00
BCIHP0718-1R0M	1.00	18.30 <sup>[11]</sup>	16.50	7.00	11.50
BCIHP0718-1R5M	1.50	34.00	22.50	6.00	10.00
BCIHP0718-2R2M	2.20	46.00	33.50	6.00 <sup>[8]</sup>	8.50
BCIHP0718-3R3M	3.30	60.00 <sup>[8]</sup>	54.00	3.25	6.00
BCIHP0718-4R7M	4.70	78.00	70.00	3.00	5.50
BCIHP0718-5R6M	5.60	108.00	92.00	2.80	5.00
BCIHP0718-6R8M	6.80	136.00	105.00	2.50	4.50
BCIHP0718-8R2M	8.20	148.00	120.00	2.30	4.00
BCIHP0718-100M	10.00	195.00	165.00	2.00	4.00
BCIHP0724-R33M IHL P-2525BD-01	0.33	4.10	3.50	18.00	22.00
BCIHP0724-R36M	0.36	5.00	4.65	16.00	21.00
BCIHP0724-R47M IHL P-2525BD-01	0.47	6.50	6.10	13.50	21.00
BCIHP0724-R56M	0.56	7.50	6.50	12.00	19.00
BCIHP0724-R68M IHL P-2525BD-01	0.68	9.40	8.00	11.00	18.00
BCIHP0724-R82M IHL P-2525BD-01	0.82	11.80	9.70	10.00	17.00
BCIHP0724-1R0M IHL P-2525BD-01	1.00	14.20	10.50	9.00	16.00
BCIHP0724-1R5M IHL P-2525BD-01	1.50	21.20	17.00	7.50	15.00 <sup>[7]</sup>
BCIHP0724-2R2M IHL P-2525BD-01	2.20	34.00	25.50	6.50	14.00 <sup>[8]</sup>
BCIHP0724-3R3M IHL P-2525EZ-01	3.30	51.60	41.50	5.00	13.00 <sup>[6]</sup>
BCIHP0724-4R7M IHL P-2525EZ-01	4.70	63.00	52.50	4.50	10.00 <sup>[9]</sup>
BCIHP0724-5R6M	5.60	80.00	60.00	4.00	6.50
BCIHP0724-6R8M IHL P-2525EZ-01	6.80	95.00	77.00	3.50	9.00 <sup>[9]</sup>
BCIHP0724-8R2M IHL P-2525EZ-01	8.20	106.00 <sup>[9]</sup>	95.00	3.00	8.00 <sup>[9]</sup>
BCIHP0724-100M IHL P-2525EZ-01	10.00	129.00	118.00	2.50	7.00 <sup>[9]</sup>
BCIHP0724-150M <sup>[6]</sup>	15.00	235.00	201.50	3.00	4.00
BCIHP0724-220M <sup>[8]</sup>	22.00	380.00	315.00	1.50	3.00

## Powder Molding Type

### BCIHP0712/15/18/24/30/50-Series

- Specification

ITEM	INDUCTANCE $\mu$ H @200KHZ,0.25V,0A(1)	DCR $m\Omega$ 25°C MAX.	DCR $m\Omega$ 25°C Typ.	HEAT RATING CURRENT DC AMPS ( <sup>5</sup> ) TYPICAL(Irms)	SATURATION CURRENT DC AMPS ( <sup>6</sup> ) TYPICAL(Isat)
BCIHP0730-R10N <sub>[8]</sub> IHLP-2525CZ-01	0.10	1.70	1.30	32.50	60.00
BCIHP0730-R15N <sub>[8]</sub> IHLP-2525CZ-01	0.15	2.50	1.70	26.00	52.00
BCIHP0730-R20N <sub>[8]</sub> IHLP-2525CZ-01	0.20	3.00	2.10	24.00	41.00
BCIHP0730-R22N <sub>[8]</sub> IHLP-2525CZ-01	0.22	2.80 <sub>[8]</sub>	2.35	23.00 <sub>[8]</sub>	40.00 <sub>[8]</sub>
BCIHP0730-R33M <sub>[8]</sub> IHLP-2525CZ-01	0.33	3.90	3.20	20.00	30.00 <sub>[2]</sub>
BCIHP0730-R47M <sub>[8]</sub> IHLP-2525CZ-01	0.47	4.20	3.80	17.50	26.00 <sub>[2]</sub>
BCIHP0730-R56M <sub>[8]</sub> IHLP-2525CZ-01	0.56	5.30	4.70	15.50	23.00 <sub>[8]</sub>
BCIHP0730-R68M <sub>[8]</sub> IHLP-2525CZ-01	0.68	5.50	4.80	15.50	25.00 <sub>[2]</sub>
BCIHP0730-R82M <sub>[8]</sub> IHLP-2525CZ-01	0.82	8.00	6.60	13.00	24.00 <sub>[2]</sub>
BCIHP0730-1R0M <sub>[8]</sub> IHLP-2525CZ-01	1.00	10.00	8.00	11.00	22.00 <sub>[2]</sub>
BCIHP0730-1R5M <sub>[8]</sub> IHLP-2525CZ-01	1.50	15.00	12.50	9.00	18.00 <sub>[2]</sub>
BCIHP0730-1R8M <sub>[8]</sub> IHLP-2525CZ-01	1.80	19.00	16.50	9.00	14.00
BCIHP0730-2R2M <sub>[8]</sub> IHLP-2525CZ-01	2.20	20.00	18.00	8.00	14.00 <sub>[2]</sub>
BCIHP0730-2R5M <sub>[8]</sub> IHLP-2525CZ-01	2.50	22.00	18.50	8.00	11.00 <sub>[8]</sub>
BCIHP0730-3R3M <sub>[8]</sub> IHLP-2525CZ-01	3.30	30.00	27.00	6.00	13.50 <sub>[3]</sub>
BCIHP0730-4R7M <sub>[8]</sub> IHLP-2525CZ-01	4.70	40.00	35.50	5.50	10.00 <sub>[3]</sub>
BCIHP0730-5R6M <sub>[8]</sub> IHLP-2525CZ-01	5.60	54.00	48.00	5.00	7.50
BCIHP0730-6R8M <sub>[8]</sub> IHLP-2525CZ-01	6.80	60.00	54.00	4.50	8.00 <sub>[3]</sub>
BCIHP0730-8R2M <sub>[8]</sub> IHLP-2525CZ-01	8.20	68.00	64.00	4.00	7.50 <sub>[3]</sub>
BCIHP0730-100M <sub>[8]</sub> IHLP-2525CZ-01	10.00	105.00	80.00	3.00	7.00 <sub>[3]</sub>
BCIHP0730-150M <sub>[8]</sub> IHLP-2525CZ-01	15.00	175.00	140.00	3.00	3.00
BCIHP0730-220M <sub>[8]</sub> IHLP-2525CZ-01	22.00	230.00	180.00	2.00	3.00
BCIHP0730-330M <sub>[8]</sub> IHLP-2525CZ-01	33.00	380.00	330.00	1.50	2.50
BCIHP0730-470M <sub>[8]</sub> IHLP-2525CZ-01	47.00	580.00	490.00	1.25	2.50
BCIHP0750-R33M <sub>[8]</sub> IHLP-2525CZ-01	0.33	3.70	3.20	21.00	26.00 <sub>[8]</sub>
BCIHP0750-R47M <sub>[8]</sub> IHLP-2525CZ-01	0.47	4.20	3.50	20.00	22.00
BCIHP0750-R56M <sub>[8]</sub> IHLP-2525CZ-01	0.56	4.50	3.70	19.00	20.00
BCIHP0750-R68M <sub>[8]</sub> IHLP-2525CZ-01	0.68	5.30	4.60	16.50	18.00
BCIHP0750-R82M <sub>[8]</sub> IHLP-2525CZ-01	0.82	7.50	6.40	15.00	18.00
BCIHP0750-1R0M <sub>[8]</sub> IHLP-2525CZ-01	1.00	9.00	7.40	13.00	16.00
BCIHP0750-1R5M <sub>[8]</sub> IHLP-2525CZ-01	1.50	13.50	11.20	11.50	13.00
BCIHP0750-2R2M <sub>[8]</sub> IHLP-2525CZ-01	2.20	15.00	12.50	11.00	12.00
BCIHP0750-3R3M <sub>[8]</sub> IHLP-2525CZ-01	3.30	29.00	23.00	8.00	10.50 <sub>[5]</sub>
BCIHP0750-4R7M <sub>[8]</sub> IHLP-2525CZ-01	4.70	37.00	31.00	6.00	8.00
BCIHP0750-5R6M <sub>[8]</sub> IHLP-2525CZ-01	5.60	45.00	40.50	5.50	6.50
BCIHP0750-6R8M <sub>[8]</sub> IHLP-2525CZ-01	6.80	46.00	42.00	5.50	7.00
BCIHP0750-8R2M <sub>[8]</sub> IHLP-2525CZ-01	8.20	78.00	60.50	5.00	5.50
BCIHP0750-100M <sub>[8]</sub> IHLP-2525CZ-01	10.00	90.00	71.50	4.00	5.50
BCIHP0750-220M <sub>[8]</sub> IHLP-2525CZ-01	22.00	155.00	142.50	3.50	4.00
BCIHP0750-330M <sub>[8]</sub> IHLP-2525CZ-01	33.00	260.00	202.50	2.00	2.00
BCIHP0750-470M <sub>[8]</sub> IHLP-2525CZ-01	47.00	330.00	284.50	1.50	1.80
BCIHP0750-680M <sub>[7]</sub> IHLP-2525CZ-01	68.00	445.00	436.00	2.00	2.50

## Powder Molding Type

### BCIHP0712/15/18/24/30/50-Series

- Specification

ITEM	INDUCTANCE $\mu$ H @200KHZ,0.25V,0A(1)	DCR $m\Omega$ 25°C MAX.	DCR $m\Omega$ 25°C Typ.	HEAT RATING CURRENT DC AMPS ( <sup>5</sup> ) TYPICAL(Irms)	SATURATION CURRENT DC AMPS ( <sup>6</sup> ) TYPICAL(Isat)
BCIHP0750LD-R18N <sub>[8]</sub>	0.18	1.80	1.50	32.00	32.00
BCIHP0750LD-R33M <sub>[8]</sub>	0.33	2.20	2.05	24.00	24.00
BCIHP0750LD-R47M <sub>[8]</sub>	0.47	3.80	3.00	21.00	22.00
BCIHP0750LD-R56M <sub>[8]</sub>	0.56	4.30	3.60	18.50	19.00
BCIHP0750LD-R68M <sub>[8]</sub> IHLP-2525EZ-01	0.68	4.50	4.35	18.00	18.00
BCIHP0750LD-R82M <sub>[4]</sub> IHLP-2525EZ-01	0.82	4.90	4.70	16.50	13.00
BCIHP0750LD-1R0M <sub>[8]</sub> IHLP-2525EZ-01	1.00	6.50	5.55	13.00	15.00
BCIHP0750LD-1R5M <sub>[4]</sub> IHLP-2525EZ-01	1.50	9.00	7.80	12.00	12.00
BCIHP0750LD-2R2M <sub>[4]</sub> IHLP-2525EZ-01	2.20	13.60	12.75	10.00	10.00
BCIHP0750LD-3R3M <sub>[4]</sub> IHLP-2525EZ-01	3.30	20.90	18.60	8.00	8.00
BCIHP0750LD-4R7M <sub>[4]</sub> IHLP-2525EZ-01	4.70	30.30	28.20	6.50	7.00
BCIHP0750LD-5R6M <sub>[8]</sub> IHLP-2525EZ-01	5.60	34.40	31.50	6.00	7.00
BCIHP0750LD-6R8M <sub>[8]</sub> IHLP-2525EZ-01	6.80	44.60	41.50	5.50	5.50
BCIHP0750LD-8R2M <sub>[8]</sub> IHLP-2525EZ-01	8.20	50.70	44.00	5.00	5.00
BCIHP0750LD-100M <sub>[4]</sub> IHLP-2525EZ-01	10.00	71.30	63.00	4.50	4.50
BCIHP0750LD-150M <sub>[8]</sub>	15.00	100.00	80.00	4.30	4.30

## Powder Molding Type

BCIHP0712/15/18/24/30/50-Series

Note:

- (1) Tolerance of Inductance:  $N=\pm 30\%$  , $M=\pm 20\%$ .
  - (2) All test data is referenced to 25°C ambient.
  - (3) Inductance is measured at 200KHz. 25°C ambient.
  - (4) Operating Temperature Range-40°C to +125°C.
  - (5) DC current (  $I_{rms}$  ) (A) that will cause an approximate  $\Delta T$  of 40°C.
  - (6) DC current (  $I_{sat}$  ) (A) that will cause  $L_0$  to drop approximately 20%.
  - (7) The part Temperature (ambient + temp rise) should not exceed 125°C under worst case operating conditions. Circuit design, component placement, PWB trace size and thickness, airflow and other cooling provisions all affect the part temperature Part temperature should be verified in the end application.
- (1) 電感的公差：  $N=\pm 30\%$  , $M=\pm 20\%$ .
  - (2) 所有的測試資料應該是在 25°C 的環境溫度下測試。
  - (3) 感值測試頻率 200KHz.
  - (4) 操作溫度範圍 -40°C 到 +125°C.
  - (5) 加 DC ( $I_{rms}$ ) 電流值 (A) 會導致  $\Delta T$  40°C 左右的變化。
  - (6) 加 DC ( $I_{sat}$ ) 電流值 (A) 會導致初始值下降 20% 左右。
  - (7) 產品的溫度不能超過 125°C，即使在最壞的操作情況下，基板設計，元件放置，PWB 尺寸和厚度，氣流和一些冷卻設備都會影響產品溫度，產品溫度要在最終應用時才被驗證。

## Powder Molding Type

BCIHP0712/15/18/24/30/50-Series

### ● Material List



NO	ITEM	Materials
1	Core	Magnetic Metal Powder or equivalent
2	Wire	Polyester Wire or equivalent
3	External Electrode	Copper
	Electroplating	Ni/Sn
4	Paint	Epoxy resin

### ● Packaging Information

#### (1) Reel Dimension & Tape Dimension / Packaging Quantity

##### Reel Dimensions

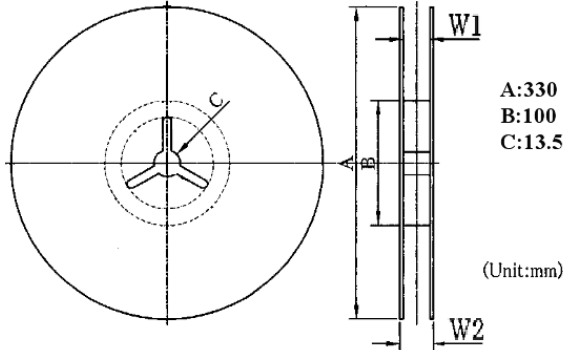

##### Tape Dimensions

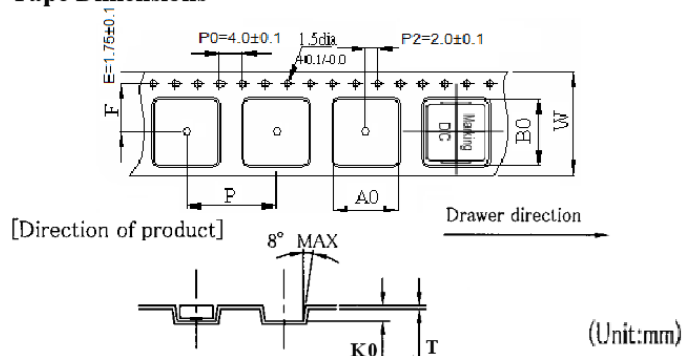

ITEM	DIMENSIONS (m/m)									
	Q'TY (PCS)	W1±0.3	W2±0.5	W±0.3	A0±0.1	B0±0.1	K0±0.1	P±0.1	F±0.1	T±0.05
BCIHP0712	2,000	16.80	23.10	16.00	7.10	7.60	1.80	12.00	7.50	0.40
BCIHP0715	2,000	16.80	23.10	16.00	7.10	7.60	1.80	12.00	7.50	0.40
BCIHP0718	1,500	16.80	23.10	16.00	7.10	7.60	2.60	12.00	7.50	0.40
BCIHP0724	1,500	16.80	23.10	16.00	7.10	7.60	2.60	12.00	7.50	0.40
BCIHP0730	1,000	16.80	23.10	16.00	7.10	7.60	3.50	12.00	7.50	0.40
BCIHP0750	800	16.80	23.10	16.00	7.00	7.50	5.15	12.00	7.50	0.40
BCIHP0750LD	800	16.80	23.10	16.00	7.00	7.50	5.15	12.00	7.50	0.40

#### (2) Tearing Off Force

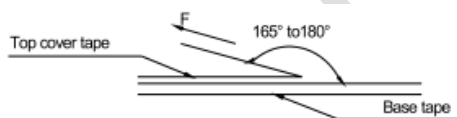

Room Temp. (°C)	Room Humidity (%)	Room atm (hPa)	Tearing Speed mm/min
5-35	45-85	860~1060	300

The force tearing off cover 10 to 130 grams (0.1N to 1.3N) in the arrow direction under the following conditions.

### ● Storage conditions/Note things

#### (1) Storage temperature and humidity conditions :

1. Product packing with Carrier tape: +5°C~+40°C and less than 60% RH.
2. Product alone: -20°C~+60°C and less than 60% RH.

#### (2) Products should be used within 6 months.

#### (3) The packaging material should be kept where no chlorine or sulfur exists in the air.

#### (4) Do not touch the electrodes (soldering terminals) with fingers as this may lead to deterioration of solder ability.

#### (5) The use of tweezers or vacuum pick-ups is strongly recommended for individual components.

#### (6) Bulk handling should ensure that abrasion and mechanical shock are minimized.

# SMD Power Inductors

BCIHP0712/15/18/24/30/50-Series

- Package for standard

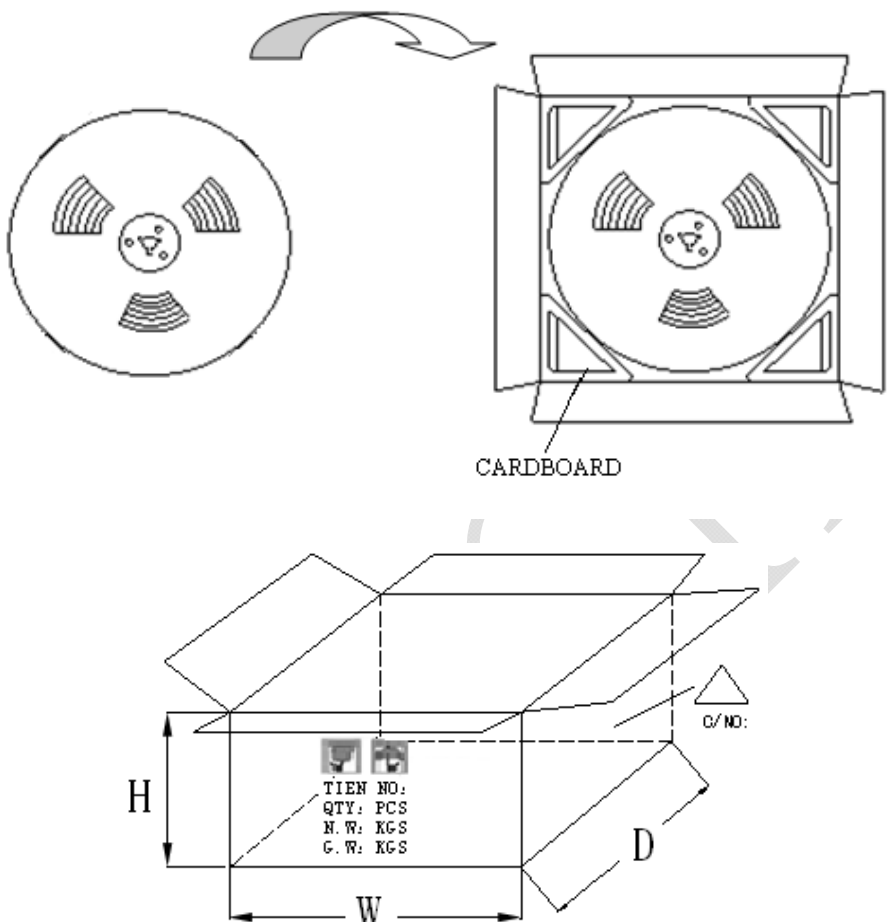
ITEM			
Packing method & Dimensions			Box Size
 <p style="text-align: center;">CARDBOARD</p>			W=345mm D=345mm H=185mm
ITEM	Packing Quantity	Reel Quantity	Total Quantity
BCIHP0712	2,000 Pcs/Reel (0.88Kg <sub>(Ref)</sub> )	6 Reel/Box	12,000 Pcs/Box (6.05Kg <sub>(Ref)</sub> )
BCIHP0715	2,000 Pcs/Reel (1.08Kg <sub>(Ref)</sub> )	6 Reel/Box	12,000 Pcs/Box (7.25Kg <sub>(Ref)</sub> )
BCIHP0718	1,500 Pcs/Reel (1.00Kg <sub>(Ref)</sub> )	6 Reel/Box	9,000 Pcs/Box (6.70Kg <sub>(Ref)</sub> )
BCIHP0724	1,500 Pcs/Reel (1.20Kg <sub>(Ref)</sub> )	6 Reel/Box	9,000 Pcs/Box (7.90Kg <sub>(Ref)</sub> )
BCIHP0730	1,000 Pcs/Reel (1.10Kg <sub>(Ref)</sub> )	6 Reel/Box	6,000 Pcs/Box (7.40Kg <sub>(Ref)</sub> )
BCIHP0750	800 Pcs/Reel (1.35Kg <sub>(Ref)</sub> )	6 Reel/Box	4,800 Pcs/Box (8.80Kg <sub>(Ref)</sub> )
BCIHP0750LD	800 Pcs/Reel (1.35Kg <sub>(Ref)</sub> )	6 Reel/Box	4,800 Pcs/Box (8.80Kg <sub>(Ref)</sub> )

## Powder Molding Type

### BCIHP0712/15/18/24/30/50-Series

#### ● General Characteristics

Operation Temperature            -40°C to +125°C (Includes temperature when the coil is heated)  
 External Appearance            On visual inspection, the coil has no external defects.

#### ● Electrical Performance Test

Inductance	Refer to standard electrical characteristics list.
DCR	
Saturation Current(Isat)	BCIHP0712/15/18/24/30/50/50LD-Series $\Delta L \leq 20\%$ typical.
Heat Rated Current(Irms)	Approximately $\Delta T \leq 40^\circ\text{C}$ .

#### ● Reliability Test

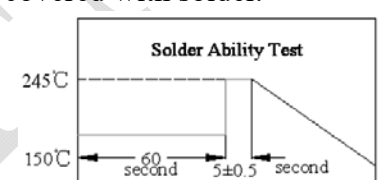
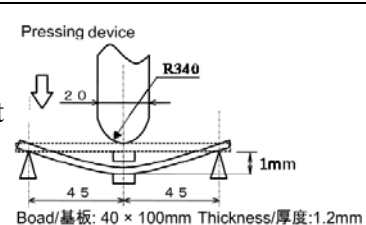
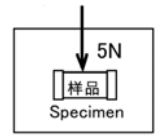
Solder Ability Test	<ol style="list-style-type: none"> <li>More than 90% of terminal electrode should be covered with solder.</li> </ol> <ul style="list-style-type: none"> <li>After fluxing, component shall be dipped in a melted.</li> <li>Solder: bath at <math>245^\circ\text{C} \pm 5^\circ\text{C}</math> for <math>5 \pm 0.5</math> seconds.</li> </ul>	
Heat resistance of Reflow Soldering Test	<ol style="list-style-type: none"> <li>Components should have not evidence of electrical and mechanical damage.</li> <li>Inductance: within <math>\pm 10\%</math> of initial value.</li> </ol> <ul style="list-style-type: none"> <li>Preheat: <math>150 \pm 5^\circ\text{C}</math> 60seconds.</li> <li>Solder temperature: <math>255 \pm 5^\circ\text{C} / -0^\circ\text{C}</math>.</li> <li>Flux: rosin.</li> <li>Dip time: <math>10 \pm 0.5</math>seconds.</li> </ul>	
Adhesion strength Test	<ol style="list-style-type: none"> <li>No apparent damage</li> </ol> <ul style="list-style-type: none"> <li>Product is mounted on PCB. Thereafter R340 pressure fixture is used to apply pressure to product from backside of the board at a rate of approx. 1mm/sec. until bending width becomes 1mm and keep it for 5sec.</li> </ul>	
Welding strength Test	<ol style="list-style-type: none"> <li>No separation or indication of electrode.</li> </ol> <ul style="list-style-type: none"> <li>A static load using a R5.0 pressing tool shall be applied to the body of the specimen in the direction of the arrow and shall be hold for <math>3 \pm 1</math> sec.</li> </ul>	
Insulating Resistance	Over 100MΩ at 100V D.C. between coil and core.	
Dielectric Strength	No dielectric breakdown at 30V D.C. for 1 minute between coil and core.	
Vibration Test	Inductance deviation within +10% after vibration for 1 hour. In each of three orientations at Sweep vibration (10~55~10HZ) with 1.5mmP-P amplitudes.	<ol style="list-style-type: none"> <li>No separation or indication of electrode.</li> <li><math>\Delta L/L \leq 15\%</math></li> </ol>
Drop Test	Inductance deviation within +10% after being dropped once with $981\text{m/s}^2$ (100G) shock Attitude upon a rubber block method shock testing machine, in three different orientations.	



## Powder Molding Type

BCIHP0712/15/18/24/30/50-Series

### ● Reliability Test

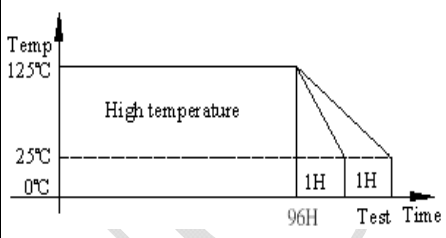
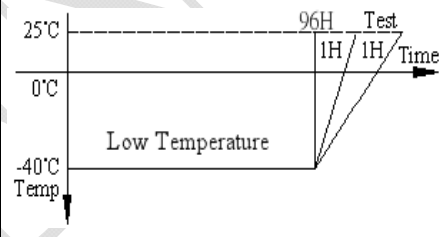
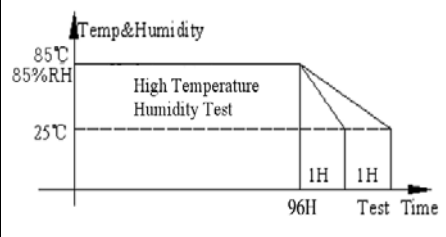
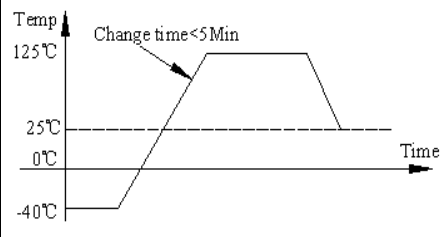
Item	Required Characteristics	Test Method/Condition
High Temperature Storage Test	<ol style="list-style-type: none"> <li>1. No case deformation or change in appearance</li> <li>2. <math>\Delta L/L \leq 15\%</math></li> <li>3. <math>\Delta Q/Q \leq 30\%</math></li> <li>4. <math>\Delta DCR/DCR \leq 15\%</math></li> </ol> <ul style="list-style-type: none"> <li>● Temperature: <math>125^{\circ}\text{C} \pm 3^{\circ}\text{C}</math> Time: <math>96 \pm 2</math> hours.</li> <li>● Tested not less than 1 hour, nor more than 2 hours at room.</li> </ul>	
Low Temperature Storage Test	<ol style="list-style-type: none"> <li>1. No case deformation or change in appearance</li> <li>2. <math>\Delta L/L \leq 15\%</math></li> <li>3. <math>\Delta Q/Q \leq 30\%</math></li> <li>4. <math>\Delta DCR/DCR \leq 15\%</math></li> </ol> <ul style="list-style-type: none"> <li>● Temperature: <math>-40^{\circ}\text{C} \pm 3^{\circ}\text{C}</math> Time: <math>96 \pm 2</math> hours.</li> <li>● Tested not less than 1 hour, nor more than 2 hours at room.</li> </ul>	
High Temperature Humidity Test	<ol style="list-style-type: none"> <li>1. No case deformation or change in appearance</li> <li>2. <math>\Delta L/L \leq 15\%</math></li> <li>3. <math>\Delta Q/Q \leq 30\%</math></li> <li>4. <math>\Delta DCR/DCR \leq 15\%</math></li> </ol> <ul style="list-style-type: none"> <li>● Temperature: <math>85^{\circ}\text{C} \pm 3^{\circ}\text{C}</math>.</li> <li>● Humidity: <math>85 \pm 5\% \text{RH}</math></li> <li>● Test Time: <math>96 \pm 2</math> hours</li> <li>● Tested not less than 1 hour. Nor more than 2 hours at room temperature.</li> </ul>	
Thermal Shock Storage Test	<ol style="list-style-type: none"> <li>1. No case deformation or change in appearance</li> <li>2. <math>\Delta L/L \leq 15\%</math></li> <li>3. <math>\Delta Q/Q \leq 30\%</math></li> <li>4. <math>\Delta DCR/DCR \leq 15\%</math></li> </ol> <ul style="list-style-type: none"> <li>● First <math>-40^{\circ}\text{C}</math> for 30 Minutes, last <math>125^{\circ}\text{C}</math> for 30 Minutes as 1 cycle. Go through 20 cycles.</li> </ul>	

# Powder Molding Type

BCIHP0712/15/18/24/30/50-Series

## ● Soldering re-flow

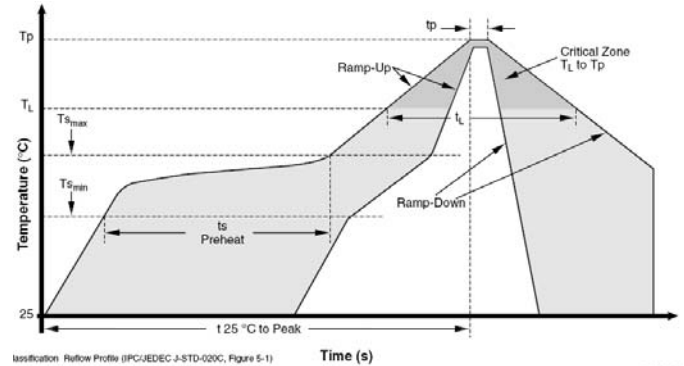
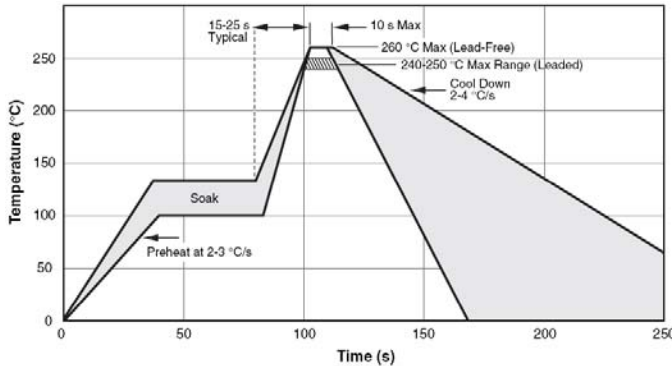

IPC/JEDEC J-STD-020C, Figure 5-1

Profile Feature	Sn-Pb Eutectic Assembly	Pb-Free Assembly
Average Ramp-Up Rate (Ts <sub>max</sub> to Tp)	3 °C/second max.	3 °C/second max.
Preheat		
± Temperature Min (Ts <sub>min</sub> )	100 °C	150 °C
± Temperature Max (Ts <sub>max</sub> )	150 °C	200 °C
± Time (ts <sub>min</sub> to ts <sub>max</sub> )	60-120 seconds	60-180 seconds
Time maintained above:		
± Temperature (T <sub>l</sub> )	183 °C	217 °C
± Time (t <sub>l</sub> )	60-150 seconds	60-150 seconds
Peak/Classification Temperature (Tp)	See Table 4.1	See Table 4.2
Time within 5 °C of actual Peak Temperature (tp)	10-30 seconds	20-40 seconds
Ramp-Down Rate	6 °C/second max.	6 °C/second max.
Time 25 °C to Peak Temperature	6 minutes max.	8 minutes max.

Table 4. Classification Reflow Profiles (per IPC/JEDEC J-STD-020C, Table 5.2)

Note 1: All temperatures refer to topside of the package, measured on the package body surface.

Package Thickness	Volume mm <sup>3</sup> <350	Volume mm <sup>3</sup> ≥350
<2.5 mm	240 +0/-5 °C	225 +0/-5 °C
≥2.5 mm	225 +0/-5 °C	225 +0/-5 °C

Table 5. SnPb Eutectic Process – Package Peak Reflow Temperatures (per IPC/JEDEC J-STD-020C, Table 4.1)

Package Thickness	Volume mm <sup>3</sup> <350	Volume mm <sup>3</sup> 350-2000	Volume mm <sup>3</sup> >2000
<1.6 mm	260 + 0 °C *	260 + 0 °C *	260 + 0 °C *
1.6 mm - 2.5 mm	260 + 0 °C *	250 + 0 °C *	245 + 0 °C *
≥2.5 mm	250 + 0 °C *	245 + 0 °C *	245 + 0 °C *

\* Tolerance: Process compatibility is up to and including the stated classification temperature (this means Peak reflow temperature + 0 °C. For example 260 °C + 0 °C) at the rated MSL level.

Table 6. Pb-free Process – Package Classification Reflow Temperatures (per IPC/JEDEC J-STD-020C, Table 4.2)

Note 1: The profiling tolerance is + 0 °C, -X °C (based on machine variation capability) whatever is required to control the profile process but at no time will it exceed -5 °C. Process compatibility at the peak reflow profile temperatures as defined in Table 4.2.

Note 2: Package volume excludes external terminals (balls, bumps, lands, leads) and/or nonintegral heat sinks.

Note 3: The maximum component temperature reached during reflow depends on package thickness and volume. The use of convection reflow processes reduces the thermal gradients between packages. However, thermal gradients due to differences in thermal mass of SMD packages may still exist.

Note 4: Components intended for use in a “lead-free” assembly process shall be evaluated using the “lead-free” classification temperatures and profiles defined in Tables 4.1, 4.2 and 5.2 whether or not lead free.

## Powder Molding Type

### BCIHP0712/15/18/24/30/50-Series

#### ● Modify records

Numbering	Date	Modify content
[1]	2015/8/27	BCIHP0718-R47M Isat: <del>18A</del> >.17A.-18A
[1]	2015/8/27	BCIHP0718-1R0M DCR: <del>18.5mΩ</del> >18.3mΩ.>18.5mΩ.
[2]	2015/8/28	BCIHP0730-R22M Isat: <del>28A</del> >30A.
[2]	2015/8/28	BCIHP0730-R47M Isat: <del>24A</del> >26A
[2]	2015/8/28	BCIHP0730-R56M Isat: <del>23A</del> >25A
[2]	2015/8/28	BCIHP0730-R68M Isat: <del>22A</del> >25A..
[2]	2015/8/28	BCIHP0730-R82M Isat: <del>19A</del> >24A.
[2]	2015/8/28	BCIHP0730-1R0M Isat:17A>22A
[2]	2015/8/28	BCIHP0730-1R5M Isat: <del>15A</del> >18A
[2]	2015/8/28	BCIHP0730-2R2M Isat: <del>12A</del> >14A
[2]	2015/8/28	BCIHP0730-2R5M Isat: <del>12A</del> >13.5A
[3]	2015/8/31	BCIHP0730-3R3M Isat: <del>10A</del> >13.5A
[3]	2015/8/31	BCIHP0730-4R7M Isat: <del>8A</del> >10A
[3]	2015/8/31	BCIHP0730-6R8M Isat: <del>7A</del> >8A
[3]	2015/8/31	BCIHP0730-8R2M Isat: <del>6A</del> >7.5A
[3]	2015/8/31	BCIHP0730-100M Isat: <del>5.5A</del> >7A
[4]	2015/11/19	Added BCIHP0750LD-R82M`BCIHP0750LD-1R5M`BCIHP0750LD-2R2M`BCIHP0750LD-3R3M BCIHP0750LD-4R7M`BCIHP0750LD-100M.
[5]	2015/11/19	BCIHP0750-3R3M Isat: <del>9.5A</del> >10.5A
[6]	2015/12/15	BCIHP0724-3R3M Isat: <del>9.0A</del> >13.0A
[6]	2015/12/15	Added BCIHP0240-150M
[7]	2015/12/25	BCIHP0724-1R5M Isat: <del>13.0A</del> >15.0A Added BCIHP0750-680M
[8]	2016/4/19	BCIHP0715-1R0M DCR: <del>18.5mΩ</del> >18.3mΩ. BCIHP0715-100M DCR: <del>265mΩ</del> >200mΩ. BCIHP0718-2R2M Irms: <del>5A</del> >6A BCIHP0718-3R3M DCR: <del>60.1mΩ</del> >60mΩ. BCIHP0724-2R2M Isat: <del>11.0A</del> >14.0A BCIHP0730-R22N DCR: <del>3.1mΩ</del> >2.8mΩ. Irms: <del>22A</del> >23A. Isat: <del>34A</del> >40A. BCIHP0730-R56M Isat: <del>25A</del> >23A BCIHP0730-2R5M Isat: <del>13.5A</del> >11A BCIHP0750-R33M Isat: <del>25A</del> >26A Added BCIHP0715-2R2M`BCIHP0715-3R3M`BCIHP0724-220M`BCIHP0730-R10N BCIHP0730-R15N`BCIHP0730-R20N`BCIHP0730-330M`BCIHP0730-470M BCIHP0750-5R6M`BCIHP0750-220M`BCIHP0750-330M`BCIHP0750-470M BCIHP0750LD-R18N`BCIHP0750LD-R33M`BCIHP0750LD-R47M`BCIHP0750LD-R56M BCIHP0750LD-R68M`BCIHP0750LD-1R0M`BCIHP0750LD-5R6M`BCIHP0750LD-6R8M BCIHP0750LD-8R2M`BCIHP0750LD-150M
[9]	2017/3/2	BCIHP0724-4R7M Isat: <del>7.0A</del> >10.0A BCIHP0724-6R8M Isat: <del>6.0A</del> >9.0A BCIHP0724-8R2M DCR: <del>120mΩ</del> >106mΩ. Isat: <del>5.0A</del> >8.0A BCIHP0724-100M Isat: <del>5.0A</del> >7.0A.