

DATA SHEET

SURFACE MOUNT MULTILAYER CERAMIC CAPACITORS

General purpose & High capacitance

Class 2, X5R

4 V TO 50 V

100 pF to 220 μ F

RoHS compliant & Halogen free



SCOPE

This specification describes X5R series chip capacitors with lead-free terminations.

APPLICATIONS

- PCs, Hard disk, Game PCs
- Power supplies
- DVD players
- Mobile phones
- Data processing

FEATURES

- Supplied in tape on reel
- Nickel-barrier end termination
- RoHS compliant
- Halogen free compliant

ORDERING INFORMATION - GLOBAL PART NUMBER, PHYCOMP CTC & I2NC

All part numbers are identified by the series, size, tolerance, TC material, packing style, voltage, process code, termination and capacitance value.

YAGEO BRAND ordering code

GLOBAL PART NUMBER (PREFERRED)

CC XXXX X X **X5R** X **BB** XXX
 (1) (2) (3) (4) (5)

(1) SIZE – INCH BASED (METRIC)

- 0201 (0603)
- 0402 (1005)
- 0603 (1608)
- 0805 (2012)
- 1206 (3216)
- 1210 (3225)

(2) TOLERANCE

- K = ±10%
- M = ±20%

(3) PACKING STYLE

- R = Paper/PE taping reel; Reel 7 inch
- K = Blister taping reel; Reel 7 inch
- P = Paper/PE taping reel; Reel 13 inch
- F = Blister taping reel; Reel 13 inch
- C = Bulk case

(4) RATED VOLTAGE

- 4 = 4 V
- 5 = 6.3 V
- 6 = 10 V
- 7 = 16 V
- 8 = 25 V
- 9 = 50 V

(5) CAPACITANCE VALUE

2 significant digits+number of zeros
 The 3rd digit signifies the multiplying factor, and letter R is decimal point
 Example: 103 = 10 × 10³ = 10,000 pF = 10 nF

CONSTRUCTION

The capacitor consists of a rectangular block of ceramic dielectric in which a number of interleaved metal electrodes are contained. This structure gives rise to a high capacitance per unit volume.

The inner electrodes are connected to the two end terminations and finally covered with a layer of plated tin (NiSn). The terminations are lead-free. A cross section of the structure is shown in Fig.1.

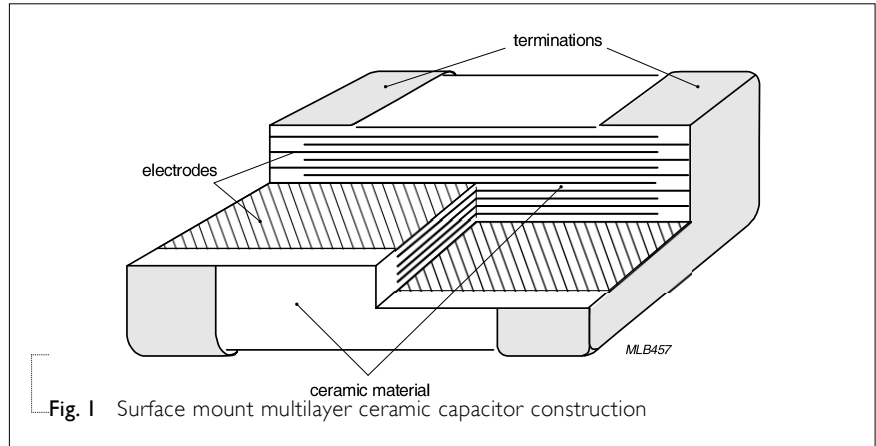

Fig. 1 Surface mount multilayer ceramic capacitor construction

DIMENSION

Table I For outlines see fig. 2

TYPE	L ₁ (mm)	W (mm)	T (MM)	L ₂ / L ₃ (mm)		L ₄ (mm)	DIMENSION CODE
				min.	max.	min.	
0201	0.6 ±0.03	0.3 ±0.03	0.3 ±0.03	0.1	0.2	0.2	BA
	0.6 ±0.05	0.3 ±0.05	0.3 ±0.05	0.1	0.2	0.2	BB
	0.6 ±0.09	0.3 ±0.09	0.3 ±0.09	0.1	0.25	0.2	BC
	0.6 ±0.15	0.3 ±0.15	0.3 ±0.15	0.1	0.25	0.2	BD
0402	1.0 ±0.05	0.5 ±0.05	0.5 ±0.05	0.15	0.35	0.4	CA
	1.0 ±0.10	0.5 ±0.10	0.5 ±0.10	0.15	0.35	0.4	CB
	1.0 ±0.15	0.5 ±0.15	0.5 ±0.15	0.15	0.35	0.4	CC
	1.0 ±0.20	0.5 ±0.20	0.5 ±0.20	0.15	0.35	0.4	CD
0603	1.6 ±0.10	0.8 ±0.10	0.8 ±0.10	0.2	0.6	0.4	DA
	1.6 ±0.15	0.8 ±0.15	0.8 ±0.15	0.2	0.6	0.4	DB
	1.6 ±0.20	0.8 ±0.20	0.8 ±0.20	0.2	0.6	0.4	DC
0805	2.0 ±0.20	1.25 ±0.20	0.85 ±0.10	0.25	0.75	0.7	EA
	2.0 ±0.20	1.25 ±0.20	1.25 ±0.20	0.25	0.75	0.7	EB
1206	3.2 ±0.15	1.6 ±0.15	1.15 ±0.10	0.25	0.75	1.4	FA
	3.2 ±0.30	1.6 ±0.20	1.25 ±0.20	0.25	0.75	1.4	FB
	3.2 ±0.30	1.6 ±0.30	1.60 ±0.20	0.25	0.80	1.4	FC
	3.2 ±0.30	1.6 ±0.30	1.60 ±0.30	0.30	0.90	1.4	FD
1210	3.2 ±0.40	2.5 ±0.30	1.25 ±0.20	0.25	0.75	1.4	GA
	3.2 ±0.40	2.5 ±0.30	1.90 ±0.20	0.25	0.75	1.4	GB
	3.2 ±0.40	2.5 ±0.30	2.5 ±0.20	0.25	0.75	1.0	GC
	3.2 ±0.40	2.5 ±0.30	2.5 ±0.30	0.25	0.75	1.0	GD

OUTLINES



Fig. 2 Surface mount multilayer ceramic capacitor dimension

CAPACITANCE RANGE & THICKNESS FOR X5R

Table 2 Sizes from 0201 to 0402

CAP.	0201					0402						
	4 V	6.3 V	10 V	16 V	25 V	50 V	4 V	6.3 V	10 V	16 V	25 V	50 V
100 pF		BA	BA	BA	BA	BA						
150 pF		BA	BA	BA	BA	BA						
220 pF		BA	BA	BA	BA	BA						
330 pF		BA	BA	BA	BA	BA						
470 pF		BA	BA	BA	BA	BA						
680 pF		BA	BA	BA	BA	BA						
1.0 nF		BA	BA	BA	BA	BA						
1.5 nF		BA	BA	BA	BA							
2.2 nF		BA	BA	BA	BA							
3.3 nF		BA	BA	BA	BA							
4.7 nF		BA	BA	BA	BA							
6.8 nF		BA	BA	BA	BA							
10 nF		BA	BA	BA	BA							
15 nF		BA	BA	BA								
22 nF		BA	BA	BA	BA			CA	CA	CA	CA	CA
33 nF		BA	BA	BA				CA	CA	CA	CA	CA
47 nF		BA	BA	BA				CA	CA	CA	CA	CA
68 nF		BA	BA	BA				CA	CA	CA	CA	CA
100 nF		BA	BA	BA	BB			CA	CA	CA	CA	CA
150 nF								CA	CA	CA	CA	CA
220 nF	BA	BA	BA	BA				CA	CA	CA	CA	CA
330 nF								CA	CA			
470 nF	BA	BA	BA	BA				CA	CA	CB	CB	CB
680 nF								CA	CA			
1.0 µF	BB	BB	BB					CA	CA	CA	CA	
2.2 µF	BC	BC	BC					CA	CA	CC	CD	
4.7 µF	BD						CC	CC	CC	CC		
10 µF							CD	CD	CD			
22 µF							CD	CD				

NOTE

1. Values in shaded cells indicate thickness class in mm
2. Capacitance value of non E-6 series is available on request

CAPACITANCE RANGE & THICKNESS FOR X5R

Table 3 Sizes from 0603 to 0805

CAP.	0603						0805					
	4V	6.3 V	10 V	16 V	25 V	50V	4V	6.3 V	10 V	16 V	25 V	50V
10 nF												
15 nF												
22 nF												
33 nF												
47nF												
68 nF												
100 nF												
150 nF												
220 nF		DA	DA	DA	DA	DA						
330 nF		DA	DA	DA	DA	DA						
470 nF		DA	DA	DA	DA	DA		EA EB	EA EB	EA EB	EB	EB
680 nF		DA	DA	DA	DA	DA		EA EB	EA EB	EA EB	EB	EB
1.0 µF		DA	DA	DA	DA	DA		EA EB	EA EB	EA EB	EB	EB
2.2 µF		DA	DA	DA	DB	DC		EA EB	EA EB	EA EB	EA EB	EB
4.7 µF		DA	DA	DB	DB			EA EB	EA EB	EB	EB	EB
10 µF		DB	DC	DC	DC			EA EB	EA EB	EB	EB	EB
22 µF		DC	DC					EB	EB	EB	EB	
47 µF	DC	DC						EB	EB			
100 µF							EB	EB				

NOTE

1. Values in shaded cells indicate thickness class in mm
2. Capacitance value of non E-6 series is available on request

Table 4 Sizes from 1206 to 1210

CAP.	1206						1210				
	4 V	6.3 V	10 V	16 V	25 V	50V	6.3 V	10 V	16 V	25 V	50V
10 nF											
15 nF											
22 nF											
33 nF											
47nF											
68 nF											
100 nF											
150 nF											
220 nF											
330 nF											
470 nF											
680 nF											
1.0 μ F		FA	FA	FA	FA	FC	GA	GA	GA	GA	GA
2.2 μ F		FA	FA	FA	FA	FC	GB	GB	GB	GB	GB
4.7 μ F		FC	FC	FC	FC	FC	GB	GB	GB	GB	GC
10 μ F		FC	FC	FC	FC	FD	GB	GB	GB	GB	GC
22 μ F		FC	FC	FC	FD		GC	GC	GC	GD	
47 μ F		FC	FC	FD			GC	GC	GC		
100 μ F		FD					GD	GD	GD		
220 μ F	FD						GD				

NOTE

1. Values in shaded cells indicate thickness class in mm
2. Capacitance value of non E-6 series is available on request

THICKNESS CLASSES AND PACKING QUANTITY

Table 5

SIZE CODE	THICKNESS CLASSIFICATION	TAPE WIDTH QUANTITY PER REEL	Ø180 MM / 7 INCH		Ø330 MM / 13 INCH		QUANTITY PER BULK CASE
			Paper	Blister	Paper	Blister	
0201	0.3 ±0.03 mm	8 mm	15,000	---	50,000	---	---
0402	0.5 ±0.05 / 0.1 mm	8 mm	10,000	---	50,000	---	50,000
	0.5 ±0.15 / 0.2 mm	8 mm	10,000	---	40,000	---	---
0603	0.8 ±0.1 mm	8 mm	4,000	---	15,000	---	15,000
0805	0.6 ±0.1 mm	8 mm	4,000	---	20,000	---	10,000
	0.85 ±0.1 mm	8 mm	4,000	---	15,000	---	8,000
	1.25 ±0.2 mm	8 mm	---	3,000	---	10,000	5,000
1206	0.6 ±0.1 mm	8 mm	4,000	---	20,000	---	---
	0.85 ±0.1 mm	8 mm	4,000	---	15,000	---	---
	1.00 / 1.15 ±0.1 mm	8 mm	---	3,000	---	10,000	---
	1.25 ±0.2 mm	8 mm	---	3,000	---	10,000	---
	1.6 ±0.15 mm	8 mm	---	2,500	---	10,000	---
1210	1.6 ±0.2 mm	8 mm	---	2,000	---	8,000	---
	0.6 / 0.7 ±0.1 mm	8 mm	---	4,000	---	15,000	---
	0.85 ±0.1 mm	8 mm	---	4,000	---	10,000	---
	1.15 ±0.1 mm	8 mm	---	3,000	---	10,000	---
	1.15 ±0.15 mm	8 mm	---	3,000	---	10,000	---
	1.25 ±0.2 mm	8 mm	---	3,000	---	---	---
	1.5 ±0.1 mm	8 mm	---	2,000	---	---	---
	1.6 / 1.9 ±0.2 mm	8 mm	---	2,000	---	---	---
2.0 ±0.2 mm	8 mm	---	2,000	---	---	---	---
	8 mm	---	1,000	---	---	---	---
2.5 ±0.2 mm	8 mm	---	1,000	---	---	---	
				500			

ELECTRICAL CHARACTERISTICS

X5R DIELECTRIC CAPACITORS; NISN TERMINATIONS

Unless otherwise specified, all tests and measurements shall be made under standard atmospheric conditions for testing as given in 5.3 of IEC 60068-1:

- Temperature: 15 °C to 35 °C
- Relative humidity: 25% to 75%
- Air pressure: 86 kPa to 106 kPa

Before the measurements are made, the capacitor shall be stored at the measuring temperature for a time sufficient to allow the entire capacitor to reach this temperature.

The period as prescribed for recovery at the end of a test is normally sufficient for this purpose.

Table 6

DESCRIPTION							VALUE
Capacitance range							100 pF to 220 μF
Capacitance tolerance							±10% and ±20%
Dissipation factor (D.F.)							
X5R	0201	0402	0603	0805	1206	1210	D.F.
≤ 6.3V	100pF to 10nF	22nF to 100nF	220nF to 1uF	470nF to 680nF	1uF to 10uF	1uF to 10uF	≤ 5%
		120nF to 220nF				22uF	≤ 7%
	12nF to 1uF	330nF to 10uF	2.2uF to 47uF	1uF to 100uF	22uF to 47uF	47uF to 220uF	≤ 10%
	2.2uF				100uF, 220uF		≤ 15%
	4.7uF	22uF					≤ 20%
10V	100pF to 10nF	22nF to 100nF	220nF to 470nF	470nF to 680nF	1uF to 4.7uF	1uF to 4.7uF	≤ 5%
		120nF to 220nF	680nF	1uF			≤ 7%
	12nF to 220nF, 1uF	330nF to 10uF	1uF to 22uF	2.2uF to 47uF	10uF to 47uF	10uF to 100uF	≤ 10%
	470nF						≤ 15%
	2.2uF						≤ 20%
16V	100pF to 10nF	22nF to 100nF	220nF to 470nF	470nF to 680nF	1uF to 4.7uF	1uF to 4.7uF	≤ 5%
		120nF to 220nF	680nF to 1uF	1 uF to 2.2μF			≤ 7%
	12nF to 220nF	470nF to 4.7uF	2.2uF to 10uF	4.7uF to 22uF	10uF to 47uF	10uF to 100uF	≤ 10%
	470nF						≤ 20%
25V	100pF to 10nF	22nF		470nF to 1uF	1uF to 2.2uF	1uF to 4.7uF	≤ 3.5%
		27nF to 100nF	220nF to 470nF	2.2uF	4.7uF	10uF	≤ 5%
		120nF to 220nF	680nF to 1uF				≤ 7%
	22nF, 100nF	470nF to 2.2uF	2.2uF to 10uF	4.7uF to 22uF	10uF to 22uF	22uF	≤ 10%
50V	100pF to 1nF	22nF					≤ 3.5%
		27nF to 120nF					≤ 5%
		150nF to 220nF					≤ 7%
		470nF	220nF to 2.2uF	470nF to 10uF	1uF to 10uF	1uF to 10uF	≤ 10%
Insulation resistance after 1 minute at Ur (DC)							Rins ≥ 10 GΩ or Rins × Cr ≥ 50/100/500* seconds whichever is less
Maximum capacitance change as a function of temperature (temperature characteristic/coefficient):							±15%
Operating temperature range:							-55 °C to +85 °C

NOTE

* Rins \geq 10 G Ω or Rins \times Cr \geq 500 Ω .F:
 0201 : 100pF to 47nF
 0402 : 22nF to 470nF
 0603 : 220nF to 1 μ F
 0805 : 470nF to 2.2 μ F, 4.7 μ F/6.3V to 16V
 1206 : 1 μ F to 2.2 μ F, 4.7 μ F/6.3V to 16V
 1210 : 1 μ F to 2.2 μ F, 4.7 μ F/6.3V to 16V

* Rins \times Cr \geq 100 Ω .F:
 0201 : 100nF to 470nF
 0402 : 1 μ F to 4.7 μ F
 0603 : 2.2 μ F to 4.7 μ F
 0805 : 4.7 μ F/16V to 50V, 10 μ F to 22 μ F/4V to 25V
 1206 : 4.7 μ F/25V to 50V, 10 μ F to 47 μ F
 1210 : 47 μ F to 220 μ F

* Rins \times Cr \geq 50 Ω .F:
 0201 : 1 μ F
 0402 : 10 μ F
 0603 : 10 μ F to 22 μ F
 0805 : 10 μ F/50V, 47 μ F to 100 μ F
 1206 : 100 μ F, 220 μ F

* Rins \times Cr \geq 20 Ω .F:
 0201 : 2.2 μ F to 4.7 μ F
 0402 : 22 μ F
 0603 : 47 μ F

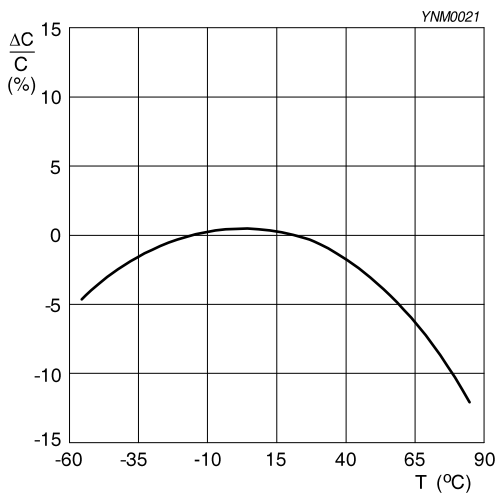

Fig. 3 Typical capacitance change as a function of temperature

Size 0201 10 nF / 16 V
 Solid lines: Impedance / Dotted lines: ESR

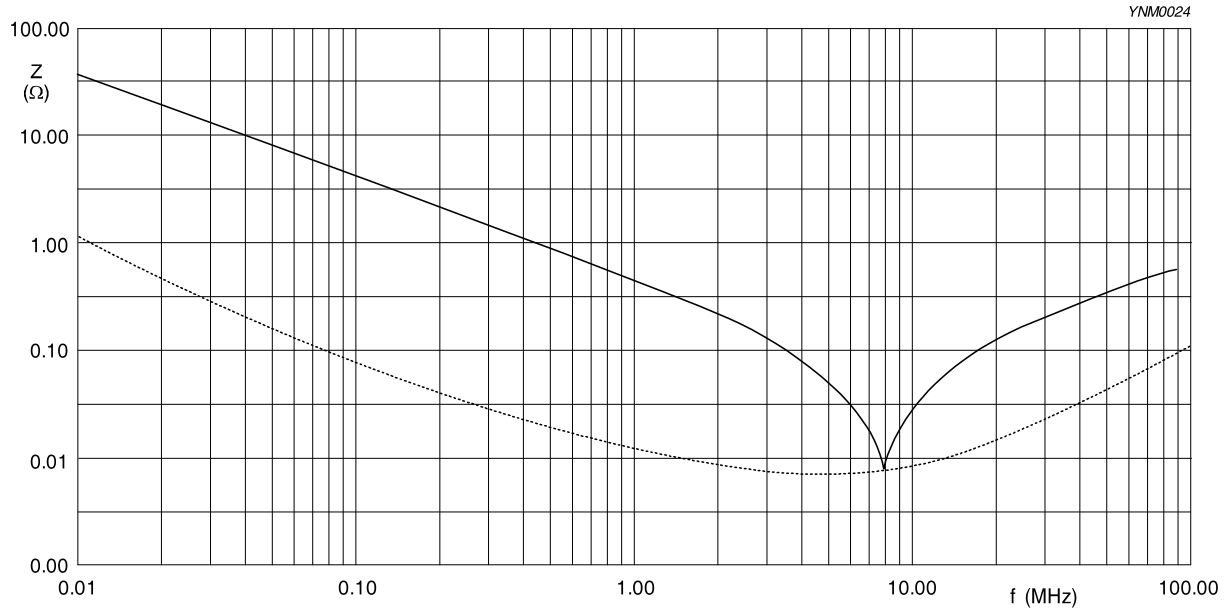

Fig. 4 Impedance ESR vs. frequency characteristics for multilayer chip capacitors

Size 0603 1 μF / 10 V
 Solid lines: Impedance / Dotted lines: ESR

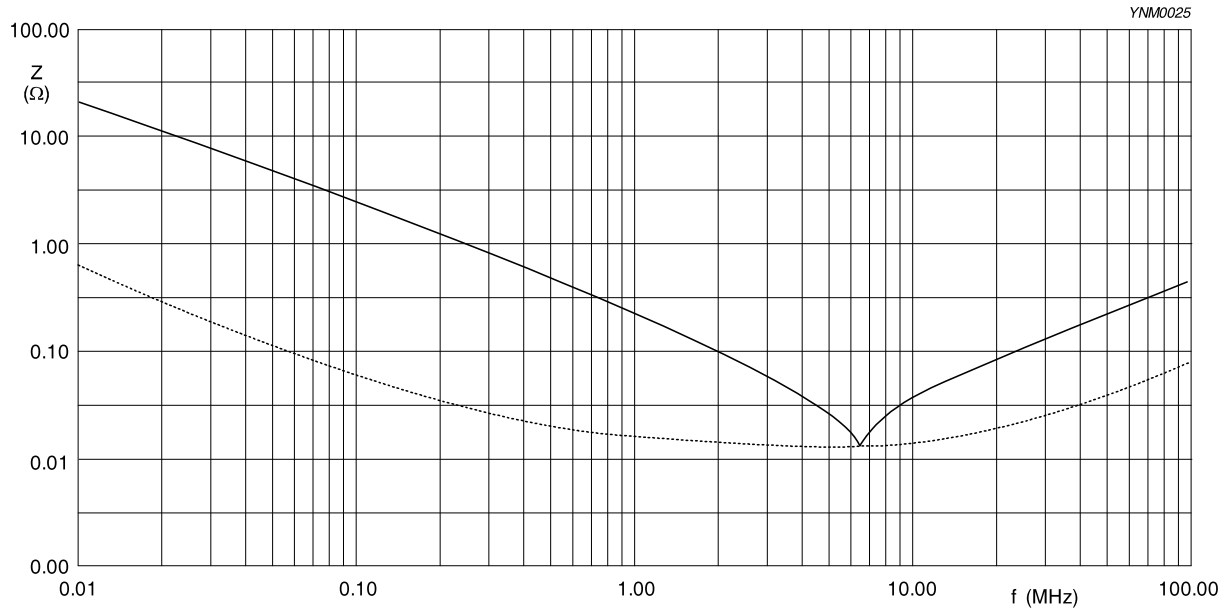

Fig. 5 Impedance ESR vs. frequency characteristics for multilayer chip capacitors

Size 0805 10 μ F / 6.3 V
Solid lines: Impedance / Dotted lines: ESR

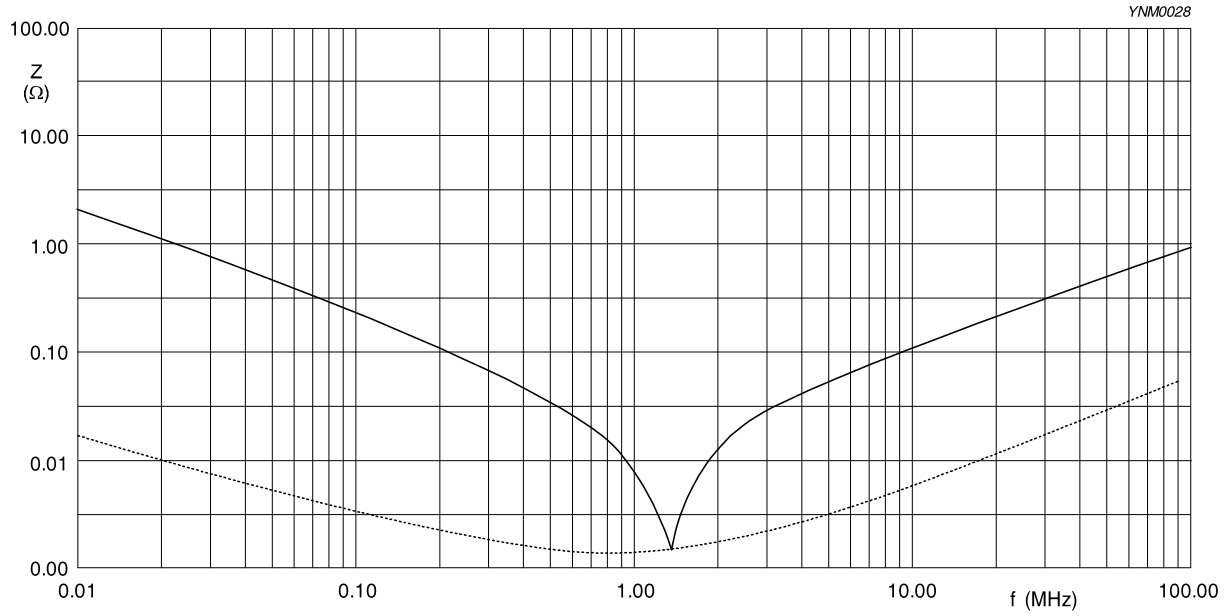

Fig. 6 Impedance ESR vs. frequency characteristics for multilayer chip capacitors

Size 1206 10 μ F / 16 V
Solid lines: Impedance / Dotted lines: ESR

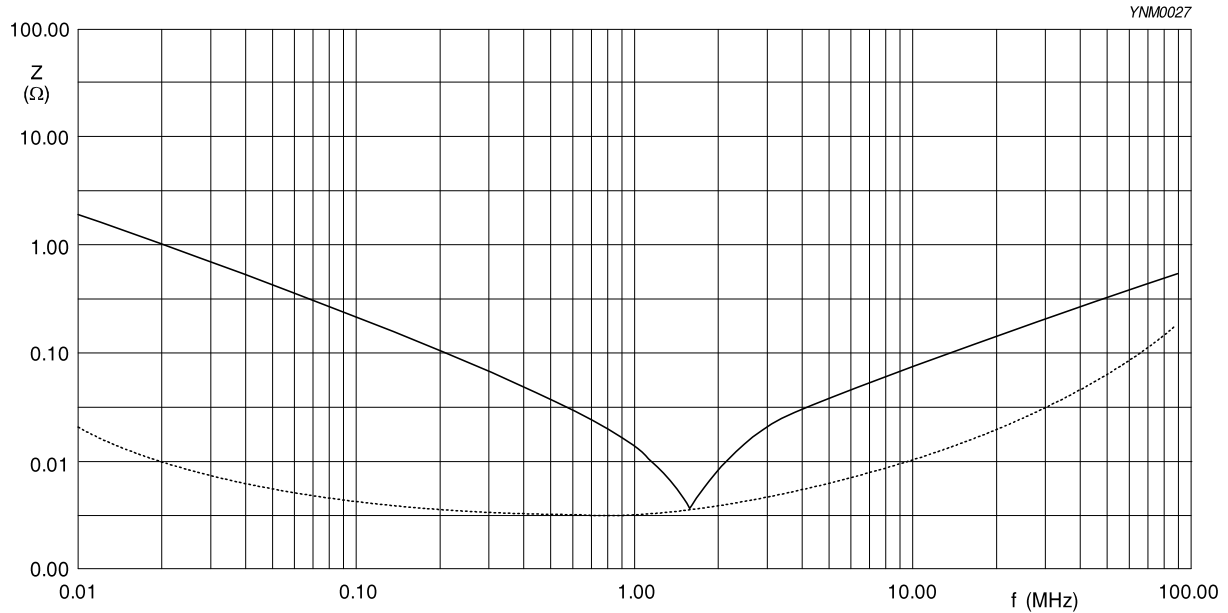
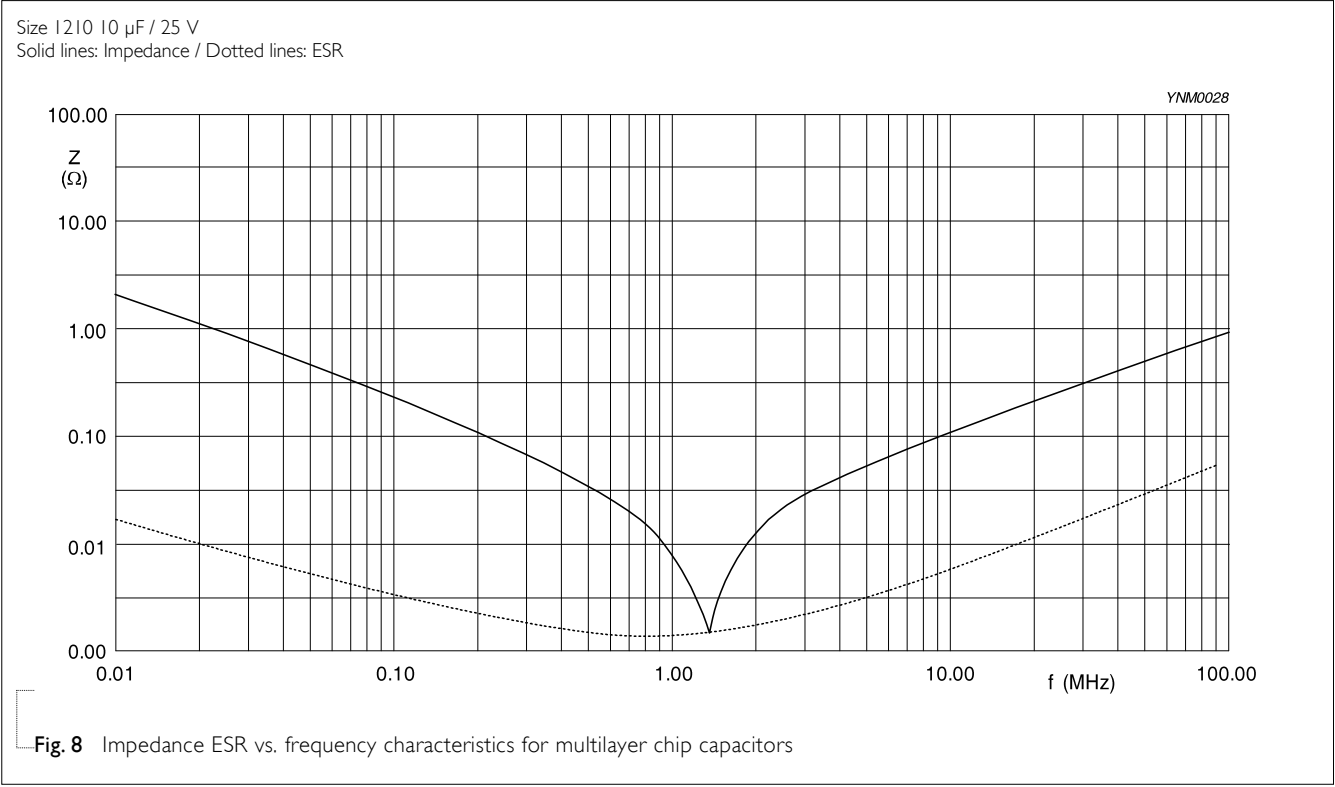

Fig. 7 Impedance ESR vs. frequency characteristics for multilayer chip capacitors



SOLDERING RECOMMENDATION

Table 7

SOLDERING METHOD	SIZE					
	0201	0402	0603	0805	1206	≥ 1210
Reflow	Reflow only	> 100 nF	> 1 μ F	> 2.2 μ F	> 2.2 μ F	Reflow only
Reflow/Wave		≤ 100 nF	≤ 1 μ F	≤ 2.2 μ F	≤ 2.2 μ F	---

TESTS AND REQUIREMENTS
Table 8 Test procedures and requirements

TEST	TEST METHOD	PROCEDURE	REQUIREMENTS
Mounting	IEC 60384-21/22 4.3	The capacitors may be mounted on printed-circuit boards or ceramic substrates	No visible damage
Visual Inspection and Dimension Check	4.4	Any applicable method using $\times 10$ magnification	In accordance with specification
Capacitance ⁽¹⁾	4.5.1	Class 2:	Within specified tolerance
Dissipation Factor (D.F.) ⁽¹⁾	4.5.2	At 20 °C, 24 hrs after annealing Cap $\leq 1 \mu\text{F}$, $f = 1 \text{ KHz}$, measuring at voltage 1 Vrms at 20 °C Cap $> 1 \mu\text{F}$, $f = 1 \text{ KHz}$ for $C \leq 10 \mu\text{F}$, rated voltage $> 6.3 \text{ V}$, measuring at voltage 1 Vrms at 20 °C $f = 1 \text{ KHz}$, for $C \leq 10 \mu\text{F}$, rated voltage $\leq 6.3 \text{ V}$, measuring at voltage 0.5 Vrms at 20 °C $f = 120 \text{ Hz}$ for $C > 10 \mu\text{F}$, measuring at voltage 0.5 Vrms at 20 °C	
Insulation Resistance	4.5.3	At U_r (DC) for 1 minute	In accordance with specification

NOTE

1. The figure indicates typical inspection. Please refer to individual specifications.

TEST	TEST METHOD	PROCEDURE	REQUIREMENTS												
Temperature Characteristic	4.6	<p>Capacitance shall be measured by the steps shown in the following table.</p> <p>The capacitance change should be measured after 5 min at each specified temperature stage.</p> <table border="1"> <thead> <tr> <th>Step</th> <th>Temperature(°C)</th> </tr> </thead> <tbody> <tr> <td>a</td> <td>25±2</td> </tr> <tr> <td>b</td> <td>Lower temperature±3°C</td> </tr> <tr> <td>c</td> <td>25±2</td> </tr> <tr> <td>d</td> <td>Upper Temperature±2°C</td> </tr> <tr> <td>e</td> <td>25±2</td> </tr> </tbody> </table> <p>(1) Class I</p> <p>Temperature Coefficient shall be calculated from the formula as below</p> $\text{Temp. Coefficient} = \frac{C2 - C1}{C1 \times \Delta T} \times 10^6 \text{ [ppm/°C]}$ <p>C1: Capacitance at step c C2: Capacitance at 125°C ΔT: 100°C(=125°C-25°C)</p> <p>(2) Class II</p> <p>Capacitance Change shall be calculated from the formula as below</p> $\Delta C = \frac{C2 - C1}{C1} \times 100\%$ <p>C1: Capacitance at step c C2: Capacitance at step b or d</p>	Step	Temperature(°C)	a	25±2	b	Lower temperature±3°C	c	25±2	d	Upper Temperature±2°C	e	25±2	<p><General purpose series></p> <p>Class1: Δ C/C: ±30ppm</p> <p>Class2: X7R: Δ C/C: ±15% Y5V: Δ C/C: 22~-82%</p> <p><High Capacitance series></p> <p>Class2: X7R/X5R: Δ C/C: ±15% Y5V: Δ C/C: 22~-82%</p>
Step	Temperature(°C)														
a	25±2														
b	Lower temperature±3°C														
c	25±2														
d	Upper Temperature±2°C														
e	25±2														
Adhesion	4.7	<p>A force applied for 10 seconds to the line joining the terminations and in a plane parallel to the substrate</p>	<p>Force</p> <p>size ≥ 0603: 5N size = 0402: 2.5N size = 0201: 1N</p>												

Bending Strength	IEC 60384-21/22	4.8	Mounting in accordance with IEC 60384-22 paragraph 4.3	No visible damage
------------------	-----------------	-----	--	-------------------

Conditions: bending 1 mm at a rate of 1 mm/s, radius jig 5 mm

Test Substrate:

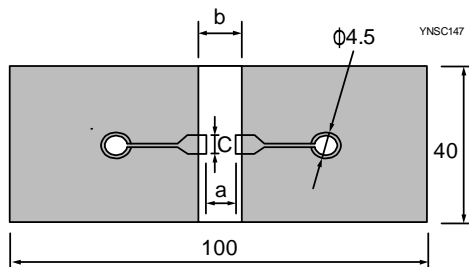

Unit: mm

Dimension(mm)			
Type	a	b	c
0201	0.3	0.9	0.3
0402	0.4	1.5	0.5
0603	1.0	3.0	1.2
0805	1.2	4.0	1.65
1206	2.2	5.0	1.65
1210	2.2	5.0	2.0

TEST	TEST METHOD	PROCEDURE	REQUIREMENTS
Resistance to Soldering Heat	4.9	Precondition: 150 +0/-10 °C for 1 hour, then keep for 24 ±1 hours at room temperature Preheating: for size ≤ 1206: 120 °C to 150 °C for 1 minute Preheating: for size >1206: 100 °C to 120 °C for 1 minute and 170 °C to 200 °C for 1 minute Solder bath temperature: 260 ±5 °C Dipping time: 10 ±0.5 seconds Recovery time: 24 ±2 hours	Dissolution of the end face plating shall not exceed 25% of the length of the edge concerned <hr/> <General purpose series> ΔC/C Class2: X5R: ±10% <hr/> <High Capacitance series> ΔC/C Class2: X5R: ±10% <hr/> D.F. within initial specified value R _{ins} within initial specified value
Solderability	4.10	Preheated the temperature of 80 °C to 140 °C and maintained for 30 seconds to 60 seconds. 1. Temperature: 235±5°C / Dipping time: 2 ±0.5 s 2. Temperature: 245±5°C / Dipping time: 3 ±0.5 s (lead free) Depth of immersion: 10mm	The solder should cover over 95% of the critical area of each termination
Rapid Change of Temperature	IEC 60384-21/22	4.11 Preconditioning: 150 +0/-10 °C for 1 hour, then keep for 24 ±1 hours at room temperature 5 cycles with following detail: 30 minutes at lower category temperature 30 minutes at upper category temperature Recovery time 24 ±2 hours	No visual damage <hr/> <General purpose series> ΔC/C Class2: X5R: ±15% <hr/> <High Capacitance series> ΔC/C Class2: X5R: ±15% <hr/> D.F. meet initial specified value R _{ins} meet initial specified value

TEST	TEST METHOD	PROCEDURE	REQUIREMENTS
Damp Heat with U_r Load	4.13	<p>1. Preconditioning, class 2 only: 150 +0/-10 °C /1 hour, then keep for 24 ±1 hour at room temp</p> <p>2. Initial measure: Spec: refer to initial spec C, D, IR</p> <p>3. Damp heat test: 500 ±12 hours at 40 ±2 °C; 90 to 95% R.H. 1.0 U_r applied</p> <p>4. Recovery: Class 2: 24 ±2 hours</p> <p>5. Final measure: C, D, IR</p> <p>P.S. If the capacitance value is less than the minimum value permitted, then after the other measurements have been made the capacitor shall be preconditioned according to "IEC 60384 4.1" and then the requirements shall be met.</p> <p>* General product: 0201 < 100nF 0402 < 1uF 0603 < 2.2uF 0805, 1206, 1210 < 4.7uF</p> <p>* High cap product: 0201 ≥ 100nF 0402 ≥ 1uF 0603 ≥ 2.2uF 0805, 1206, 1210 ≥ 4.7uF</p>	<p>No visual damage after recovery</p> <p><General purpose series></p> <p>$\Delta C/C$</p> <p>Class2: X5R: ±15%</p> <p>D.F.</p> <p>Class2: X5R:</p> <p>≤ 16V: ≤ 7% or 2 x initial value whichever is greater</p> <p>≥ 25V: ≤ 5% or 2 x initial value whichever is greater</p> <p>R_{ins}</p> <p>Class2: X5R: ≥ 500 MΩ or $R_{ins} \times C_r \geq 25s$ whichever is less</p> <p><High Capacitance series></p> <p>$\Delta C/C$</p> <p>Class2: X5R: ±20%</p> <p>D.F.</p> <p>Class2: X5R: 2 x initial value max</p> <p>R_{ins}</p> <p>Class2: $R_{ins} \times C_r \geq 5s$ whichever is less</p>

TEST	TEST METHOD	PROCEDURE	REQUIREMENTS
Endurance	IEC 60384-21/22 4.14	<p>1. Preconditioning, class 2 only: 150 +0/-10 °C /1 hour, then keep for 24 ±1 hour at room temp</p> <p>2. Initial measure: Spec: refer to initial spec C, D, IR</p> <p>3. Endurance test: Temperature: X5R: 85 °C Specified stress voltage applied for 1,000 hours: Applied 2.0 × Ur for general product*. Applied 1.5 × Ur for high cap. product*. Applied 1.0 × Ur for high cap. product*.</p> <p>4. Recovery time: 24 ±2 hours</p> <p>5. Final measure: C, D, IR</p> <p>P.S. If the capacitance value is less than the minimum value permitted, then after the other measurements have been made the capacitor shall be preconditioned according to "IEC 60384 4.1" and then the requirements shall be met.</p> <p>* General product (Applied 2.0 × Ur): 0201 < 100nF 0402 < 1uF 0603 < 2.2uF 0805, 1206, 1210 < 4.7uF</p> <p>* High cap product (Applied 1.5 × Ur): 0201 ≥ 100nF 0402 ≥ 1uF 0603 ≥ 2.2uF 0805, 1206, 1210 ≥ 4.7uF</p> <p>* High cap product (Applied 1.0 × Ur): 0201: 100nF/25V, 2.2uF to 4.7uF 0402: 4.7uF to 22uF 0603: 10uF/10V to 25V 22uF to 47uF 0805: 10uF/ 25V, 50V, 22uF to 100uF 1206: 10uF/ 50V</p>	<p>No visual damage</p> <hr/> <p><General purpose series></p> <p>ΔC/C Class2: X5R: ±15% D.F. Class2: X5R: ≤ 16V: ≤ 7% or 2 × initial value whichever is greater ≥ 25V: ≤ 5% or 2 × initial value whichever is greater R_{ins} Class2: X5R: ≥ 1,000 MΩ or R_{ins} × C_r ≥ 50s whichever is less</p> <p><High Capacitance series></p> <p>ΔC/C Class 2: X5R: ±20% D.F. Class 2: X5R: 2 × initial value max R_{ins} Class 2: R_{ins} × C_r ≥ 10s whichever is less</p>
Voltage Proof	4.6	<p>Specified stress voltage applied for 1~5 seconds</p> <p>Ur ≤ 100 V: series applied 2.5 Ur 100 V < Ur ≤ 200 V series applied (1.5 Ur + 100)</p> <p>200 V < Ur ≤ 500 V series applied (1.3 Ur + 100)</p> <p>Ur > 500 V: 1.3 Ur Ur ≥ 1000 V: 1.2 Ur</p> <p>Charge/Discharge current is less than 50 mA</p>	No breakdown or flashover

REVISION HISTORY

REVISION	DATE	CHANGE NOTIFICATION	DESCRIPTION
Version 25	Jun. 2, 2017	-	- I.R spec updated
Version 24	Mar. 6, 2017	-	- 0805 L4 spec updated
Version 23	Nov. 15, 2016	-	- Dimension updated
Version 22	Oct. 3, 2016	-	- Dimension and Soldering recommendation updated
Version 21	Jan. 28, 2016	-	- Tests and requirements updated
Version 20	Dec. 04, 2015	-	- Size updated
Version 19	Apr. 09, 2015	-	- Voltage updated
Version 18	Jul. 07, 2014	-	- Voltage updated
Version 17	Mar. 31, 2014	-	- Test condition updated
Version 16	Nov. 29, 2012	-	- Test condition updated
Version 15	Sep. 03, 2012	-	- Test condition updated
Version 14	May 16, 2012	-	- Product range updated
Version 13	May 02, 2012	-	- Product range updated
Version 12	Feb 10, 2012	-	- Product range updated
Version 11	Oct 21, 2011	-	- Product range updated
Version 10	Jun 21, 2011	-	- Product range updated
Version 9	Mar 23, 2011	-	- Product range updated
Version 8	Jan 25, 2011	-	- Rated voltage of 0201 extend to 50V
Version 7	Jan 05, 2011	-	- Product range updated
Version 6	Jul 27, 2010	-	- Dimension on 0603 and 1206 case size updated
Version 5	Apr 21, 2010	-	- The statement of "Halogen free" on the cover added - Dimension updated
Version 4	Jan 13, 2010	-	- Thickness updated
Version 3	Aug 17, 2009	-	- Dimension updated
Version 2	Jun 09, 2009	-	- Ordering code updated
Version 1	May 15, 2009	-	- Product range updated
Version 0	Apr 15, 2009	-	- New datasheet for general purpose and high capacitance X5R series with RoHS compliant - Replace the "6.3V to 50V" part of pdf files: UP-X5R_X7R_HighCaps_6.3-to-25V_11, UY-X5R_X7R_HighCaps_6.3-to-25V_11 - Combine 0201 from pdf files: UP-NP0X5RX7RY5V_0201_6.3-to-50V_2 and UY-NPOX5RX7RY5V_0201_6.3-to-50V_2 - Define global part number - Description of "Halogen free compliant" added - Test method and procedure updated