

## High-Accuracy, Hall-Effect-Based Current Sensor IC with Common-Mode Field Rejection in High-Isolation SOIC16 Package

### FEATURES AND BENEFITS

- Differential Hall sensing rejects common-mode fields
- Patented integrated digital temperature compensation circuitry allows for near closed loop accuracy over temperature in an open loop sensor
- UL60950-1 (ed. 2) certified
  - Dielectric Strength Voltage = 4.8 kV<sub>RMS</sub>
  - Basic Isolation Working Voltage = 1097 V<sub>RMS</sub>
  - Reinforced Isolation Working Voltage = 565 V<sub>RMS</sub>
- Industry-leading noise performance with greatly improved bandwidth through proprietary amplifier and filter design techniques
- Filter pin allows user to filter output for improved resolution at lower bandwidth
- 0.85 mΩ primary conductor resistance for low power loss and high inrush current withstand capability
- Low-profile SOIC16 package suitable for space-constrained applications
- 4.5 to 5.5 V single supply operation
- Output voltage proportional to AC or DC current

Continued on the next page...



TÜV America  
Certificate Number:  
U8V 14 11 54214 030  
CB 14 11 54214 029



CB Certificate Number:  
US-22339-A1-UL

### Package: 16-pin SOICW (suffix MA)

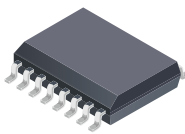

Not to scale

### DESCRIPTION

The Allegro™ ACS724KMA current sensor IC is an economical and precise solution for AC or DC current sensing in industrial, commercial, and communication systems. The small package is ideal for space-constrained applications while also saving costs due to reduced board area. Typical applications include motor control, load detection and management, switched-mode power supplies, and overcurrent fault protection.

The device consists of a precise, low-offset, linear Hall sensor circuit with a copper conduction path located near the surface of the die. Applied current flowing through this copper conduction path generates a magnetic field which is sensed by the integrated Hall IC and converted into a proportional voltage. The current is sensed differentially in order to reject common-mode fields, improving accuracy in magnetically noisy environments. The inherent device accuracy is optimized through the close proximity of the magnetic field to the Hall transducer. A precise, proportional voltage is provided by the low-offset, chopper-stabilized BiCMOS Hall IC, which includes Allegro's patented digital temperature compensation, resulting in extremely accurate performance over temperature. The output of the device has a positive slope when an increasing current flows through the primary copper conduction path (from pins 1 through 4, to pins 5 through 8), which is the path used for current sensing. The internal resistance of this conductive path is 0.85 mΩ typical, providing low power loss.

The terminals of the conductive path are electrically isolated from the sensor leads (pins 9 through 16). This allows the ACS724KMA current sensor IC to be used in high-side current sense applications without the use of high-side differential amplifiers or other costly isolation techniques.

Continued on the next page...

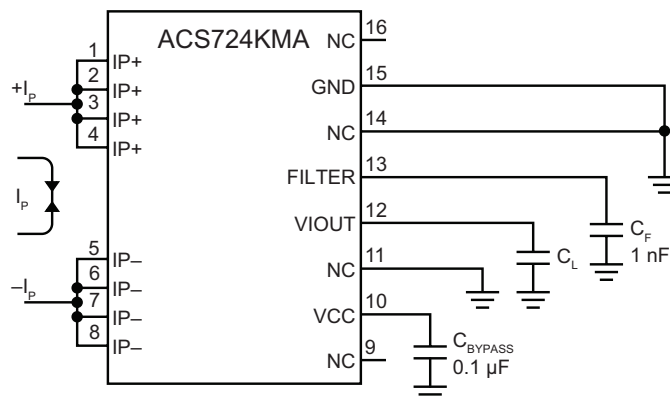

Typical Application

The ACS724KMA outputs an analog signal,  $V_{IOUT}$ , that changes proportionally with the bidirectional AC or DC primary sensed current,  $I_p$ , within the specified measurement range.

The FILTER pin can be used to decrease the bandwidth in order to optimize the noise performance.

# ACS724KMA

## High-Accuracy, Hall-Effect-Based Current Sensor IC with Common-Mode Field Rejection in High-Isolation SOIC16 Package

### FEATURES AND BENEFITS (continued)

- Factory-trimmed sensitivity and quiescent output voltage for improved accuracy
- Chopper stabilization results in extremely stable quiescent output voltage
- Nearly zero magnetic hysteresis
- Ratiometric output from supply voltage

### DESCRIPTION (continued)

The ACS724KMA is provided in a low-profile surface-mount SOIC16 package. The leadframe is plated with 100% matte tin, which is compatible with standard lead (Pb) free printed circuit board assembly processes. Internally, the device is Pb-free. The device is fully calibrated prior to shipment from the factory.

### SELECTION GUIDE

Part Number	I <sub>PR</sub> (A)	Sens(Typ) at V <sub>CC</sub> = 5 V (mV/A)	T <sub>A</sub> (°C)	Packing [1]
ACS724KMATR-12AB-T	±12	166	-40 to 125	Tape and Reel, 1000 pieces per reel
ACS724KMATR-20AB-T	±20	100		
ACS724KMATR-30AB-T	±30	66		
ACS724KMATR-30AU-T	30	132		
ACS724KMATR-65AB-T	±65	30.75		

[1] Contact Allegro for additional packing options.



### SPECIFICATIONS

#### ABSOLUTE MAXIMUM RATINGS

Characteristic	Symbol	Notes	Rating	Units
Supply Voltage	$V_{CC}$		6	V
Reverse Supply Voltage	$V_{RCC}$		-0.1	V
Output Voltage	$V_{IOUT}$		$V_{CC} + 0.5$	V
Reverse Output Voltage	$V_{RIOUT}$		-0.1	V
Operating Ambient Temperature	$T_A$	Range K	-40 to 125	°C
Junction Temperature	$T_J(\text{max})$		165	°C
Storage Temperature	$T_{stg}$		-65 to 165	°C

#### ISOLATION CHARACTERISTICS

Characteristic	Symbol	Notes	Rating	Unit
Dielectric Strength Test Voltage	$V_{ISO}$	Agency type-tested for 60 seconds per UL 60950-1 (edition 2). Production tested at 3000 $V_{RMS}$ for 1 second, in accordance with UL 60950-1 (edition 2).	4800	$V_{RMS}$
Working Voltage for Basic Isolation	$V_{WVBI}$	Maximum approved working voltage for basic (single) isolation according to UL 60950-1 (edition 2).	1550	$V_{PK}$
			1097	$V_{RMS}$ or VDC
Working Voltage for Reinforced Isolation	$V_{WVRI}$	Maximum approved working voltage for reinforced isolation according to UL 60950-1 (edition 2).	800	$V_{PK}$
			565	$V_{RMS}$ or VDC
Clearance	$D_{cl}$	Minimum distance through air from IP leads to signal leads.	7.5	mm
Creepage	$D_{cr}$	Minimum distance along package body from IP leads to signal leads	8.2	mm

#### THERMAL CHARACTERISTICS

Characteristic	Symbol	Test Conditions*	Value	Units
Package Thermal Resistance (Junction to Ambient)	$R_{\theta JA}$	Mounted on the Allegro 85-0738 evaluation board with 700 mm <sup>2</sup> of 4 oz. copper on each side, connected to pins 1 and 2, and to pins 3 and 4, with thermal vias connecting the layers. Performance values include the power consumed by the PCB.	23	°C/W
Package Thermal Resistance (Junction to Lead)	$R_{\theta JL}$	Mounted on the Allegro ASEK724 evaluation board.	5	°C/W

\*Additional thermal information available on the Allegro website.

# ACS724KMA

*High-Accuracy, Hall-Effect-Based Current Sensor IC with  
Common-Mode Field Rejection in High-Isolation SOIC16 Package*

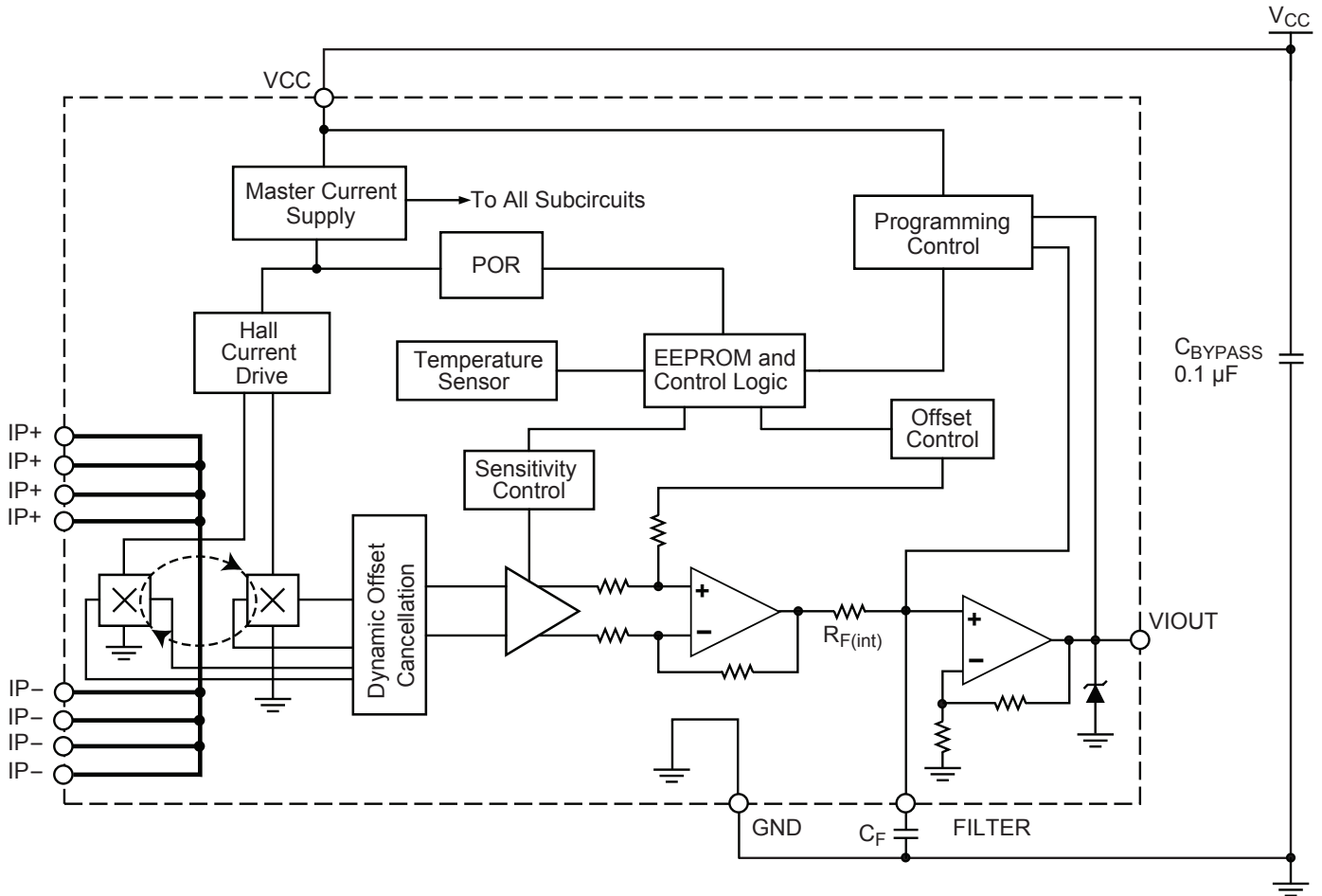

**Functional Block Diagram**

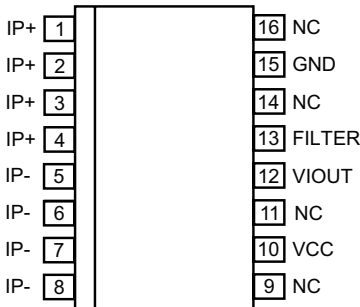

**Pinout Diagram**

**Terminal List Table**

Number	Name	Description
1, 2, 3, 4	IP+	Terminals for current being sensed; fused internally
5, 6, 7, 8	IP-	Terminals for current being sensed; fused internally
9, 16	NC	No internal connection; recommended to be left unconnected in order to maintain high creepage
10	VCC	Device power supply terminal
11, 14	NC	No internal connection; recommended to connect to GND for the best ESD performance
12	VIOUT	Analog output signal
13	FILTER	Terminal for external capacitor that sets bandwidth
15	GND	Signal ground terminal

**COMMON ELECTRICAL CHARACTERISTICS [1]:** Valid through the full range of  $T_A = -40^\circ\text{C}$  to  $125^\circ\text{C}$  and  $V_{CC} = 5\text{ V}$ , unless otherwise specified

Characteristic	Symbol	Test Conditions	Min.	Typ.	Max.	Units
Supply Voltage	$V_{CC}$		4.5	5	5.5	V
Supply Current	$I_{CC}$	$V_{CC}$ within $V_{CC}(\text{min})$ and $V_{CC}(\text{max})$	–	10	14	mA
Output Capacitance Load	$C_L$	VIOOUT to GND	–	–	10	nF
Output Resistive Load	$R_L$	VIOOUT to GND	4.7	–	–	k $\Omega$
Primary Conductor Resistance	$R_{IP}$	$T_A = 25^\circ\text{C}$	–	0.85	–	m $\Omega$
Internal Filter Resistance [2]	$R_{F(\text{INT})}$		–	1.7	–	k $\Omega$
Primary Hall Coupling Factor	G1	$T_A = 25^\circ\text{C}$	–	4.5	–	G/A
Secondary Hall Coupling Factor	G2	$T_A = 25^\circ\text{C}$	–	0.5	–	G/A
Hall Plate Sensitivity Matching	Sens <sub>MATCH</sub>	$T_A = 25^\circ\text{C}$	–	$\pm 1$	–	%
Hysteresis	$I_{\text{HYS}}$	Difference in offset after a $\pm 40\text{ A}$ pulse	–	150	–	mA
Rise Time	$t_r$	$I_P = I_P(\text{max})$ , $T_A = 25^\circ\text{C}$ , $C_L = 1\text{ nF}$	–	3	–	$\mu\text{s}$
Propagation Delay	$t_{pd}$	$I_P = I_P(\text{max})$ , $T_A = 25^\circ\text{C}$ , $C_L = 1\text{ nF}$	–	2	–	$\mu\text{s}$
Response Time	$t_{\text{RESPONSE}}$	$I_P = I_P(\text{max})$ , $T_A = 25^\circ\text{C}$ , $C_L = 1\text{ nF}$	–	4	–	$\mu\text{s}$
Internal Bandwidth	BW	Small signal $-3\text{ dB}$ , $C_L = 1\text{ nF}$	–	120	–	kHz
Noise Density	$I_{\text{ND}}$	Input-referenced noise density; $T_A = 25^\circ\text{C}$ , $C_L = 1\text{ nF}$	–	450	–	$\mu\text{A}_{\text{RMS}}/\sqrt{\text{Hz}}$
Noise	$I_{\text{N}}$	Input-referenced noise; $C_F = 4.7\text{ nF}$ , $C_L = 1\text{ nF}$ , BW = 18 kHz, $T_A = 25^\circ\text{C}$	–	60	–	$\text{mA}_{\text{RMS}}$
Nonlinearity	$E_{\text{LIN}}$	Through full range of $I_P$	–	$\pm 1$	–	%
Sensitivity Ratiometry Coefficient	SENS_RAT_COEF	$V_{CC} = 4.5\text{ to }5.5\text{ V}$ , $T_A = 25^\circ\text{C}$	–	1.3	–	–
Zero-Current Output Ratiometry Coefficient	QVO_RAT_COEF	$V_{CC} = 4.5\text{ to }5.5\text{ V}$ , $T_A = 25^\circ\text{C}$	–	1	–	–
Saturation Voltage [3]	$V_{\text{OH}}$	$R_L = 4.7\text{ k}\Omega$ , $T_A = 25^\circ\text{C}$	$V_{CC} - 0.5$	–	–	V
	$V_{\text{OL}}$	$R_L = 4.7\text{ k}\Omega$ , $T_A = 25^\circ\text{C}$	–	–	0.5	V
Power-On Time	$t_{\text{PO}}$	Output reaches 90% of steady-state level, $T_A = 25^\circ\text{C}$ , $I_P = I_{\text{PR}}(\text{max})$ applied	–	80	–	$\mu\text{s}$
Shorted Output to Ground Current	$I_{\text{SC}(\text{GND})}$	$T_A = 25^\circ\text{C}$	–	3.3	–	mA
Shorted Output to $V_{CC}$ Current	$I_{\text{SC}(\text{VCC})}$	$T_A = 25^\circ\text{C}$	–	45	–	mA

[1] Device may be operated at higher primary current levels,  $I_P$ , ambient temperatures,  $T_A$ , and internal leadframe temperatures, provided the Maximum Junction Temperature,  $T_J(\text{max})$ , is not exceeded.

[2]  $R_{F(\text{INT})}$  forms an RC circuit via the FILTER pin.

[3] The sensor IC will continue to respond to current beyond the range of  $I_P$  until the high or low saturation voltage; however, the nonlinearity in this region will be worse than through the rest of the measurement range.

xKMATR-12AB PERFORMANCE CHARACTERISTICS:  $T_A$  Range K, valid at  $T_A = -40^\circ\text{C}$  to  $125^\circ\text{C}$ ,  $V_{CC} = 5\text{ V}$ , unless otherwise specified

Characteristic	Symbol	Test Conditions	Min.	Typ. [1]	Max.	Units
<b>NOMINAL PERFORMANCE</b>						
Current Sensing Range	$I_{PR}$		-12	-	12	A
Sensitivity	Sens	$I_{PR(\min)} < I_P < I_{PR(\max)}$	-	166	-	mV/A
Zero Current Output Voltage	$V_{IOUT(Q)}$	Bidirectional; $I_P = 0\text{ A}$	-	$V_{CC} \times 0.5$	-	V
<b>ACCURACY PERFORMANCE</b>						
Total Output Error [2]	$E_{TOT}$	$I_P = I_{PR(\max)}$ , $T_A = 25^\circ\text{C}$ to $125^\circ\text{C}$	-2.5	$\pm 1$	2.5	%
		$I_P = I_{PR(\max)}$ , $T_A = -40^\circ\text{C}$ to $25^\circ\text{C}$	-	$\pm 3$	-	%
<b>TOTAL OUTPUT ERROR COMPONENTS [3]: <math>E_{TOT} = E_{SENS} + 100 \times V_{OE} / (\text{Sens} \times I_P)</math></b>						
Sensitivity Error	$E_{SENS}$	$T_A = 25^\circ\text{C}$ to $125^\circ\text{C}$ , measured at $I_P = I_{PR(\max)}$	-2	$\pm 1$	2	%
		$T_A = -40^\circ\text{C}$ to $25^\circ\text{C}$ , measured at $I_P = I_{PR(\max)}$	-	$\pm 2.8$	-	%
Offset Voltage	$V_{OE}$	$I_P = 0\text{ A}$ , $T_A = 25^\circ\text{C}$ to $125^\circ\text{C}$	-15	$\pm 5$	15	mV
		$I_P = 0\text{ A}$ , $T_A = -40^\circ\text{C}$ to $25^\circ\text{C}$	-	$\pm 20$	-	mV
<b>LIFETIME DRIFT CHARACTERISTICS</b>						
Sensitivity Error Lifetime Drift	$E_{\text{sens\_drift}}$		-	$\pm 1$	-	%
Total Output Error Lifetime Drift	$E_{\text{tot\_drift}}$		-	$\pm 1$	-	%

[1] Typical values with +/- are 3 sigma values.

[2] Percentage of  $I_P$ , with  $I_P = I_{PR(\max)}$ .

[3] A single part will not have both the maximum/minimum sensitivity error and maximum/minimum offset voltage, as that would violate the maximum/minimum total output error specification. Also, 3 sigma distribution values are combined by taking the square root of the sum of the squares. See Application Information section.

**xKMATR-20AB PERFORMANCE CHARACTERISTICS: T<sub>A</sub> Range K, valid at T<sub>A</sub> = -40°C to 125°C, V<sub>CC</sub> = 5 V, unless otherwise specified**

Characteristic	Symbol	Test Conditions	Min.	Typ. <sup>[1]</sup>	Max.	Units
<b>NOMINAL PERFORMANCE</b>						
Current Sensing Range	I <sub>PR</sub>		-20	-	20	A
Sensitivity	Sens	I <sub>PR(min)</sub> < I <sub>P</sub> < I <sub>PR(max)</sub>	-	100	-	mV/A
Zero Current Output Voltage	V <sub>IOUT(Q)</sub>	Bidirectional; I <sub>P</sub> = 0 A	-	V <sub>CC</sub> × 0.5	-	V
<b>ACCURACY PERFORMANCE</b>						
Total Output Error <sup>[2]</sup>	E <sub>TOT</sub>	I <sub>P</sub> = I <sub>PR(max)</sub> , T <sub>A</sub> = 25°C to 125°C	-2.5	±1	2.5	%
		I <sub>P</sub> = I <sub>PR(max)</sub> , T <sub>A</sub> = -40°C to 25°C	-	±3	-	%
<b>TOTAL OUTPUT ERROR COMPONENTS <sup>[3]</sup>: E<sub>TOT</sub> = E<sub>SENS</sub> + 100 × V<sub>OE</sub> / (Sens × I<sub>P</sub>)</b>						
Sensitivity Error	E <sub>SENS</sub>	T <sub>A</sub> = 25°C to 125°C, measured at I <sub>P</sub> = I <sub>PR(max)</sub>	-2	±1	2	%
		T <sub>A</sub> = -40°C to 25°C, measured at I <sub>P</sub> = I <sub>PR(max)</sub>	-	±2.8	-	%
Offset Voltage	V <sub>OE</sub>	I <sub>P</sub> = 0 A, T <sub>A</sub> = 25°C to 125°C	-15	±5	15	mV
		I <sub>P</sub> = 0 A, T <sub>A</sub> = -40°C to 25°C	-	±20	-	mV
<b>LIFETIME DRIFT CHARACTERISTICS</b>						
Sensitivity Error Lifetime Drift	E <sub>sens_drift</sub>		-	±1	-	%
Total Output Error Lifetime Drift	E <sub>tot_drift</sub>		-	±1	-	%

<sup>[1]</sup> Typical values with +/- are 3 sigma values.

<sup>[2]</sup> Percentage of I<sub>P</sub>, with I<sub>P</sub> = I<sub>PR(max)</sub>.

<sup>[3]</sup> A single part will not have both the maximum/minimum sensitivity error and maximum/minimum offset voltage, as that would violate the maximum/minimum total output error specification. Also, 3 sigma distribution values are combined by taking the square root of the sum of the squares. See Application Information section.

**xKMATR-30AB PERFORMANCE CHARACTERISTICS: T<sub>A</sub> Range K, valid at T<sub>A</sub> = -40°C to 125°C, V<sub>CC</sub> = 5 V, unless otherwise specified**

Characteristic	Symbol	Test Conditions	Min.	Typ. <sup>[1]</sup>	Max.	Units
<b>NOMINAL PERFORMANCE</b>						
Current Sensing Range	I <sub>PR</sub>		-30	-	30	A
Sensitivity	Sens	I <sub>PR(min)</sub> < I <sub>P</sub> < I <sub>PR(max)</sub>	-	66	-	mV/A
Zero Current Output Voltage	V <sub>IOUT(Q)</sub>	Bidirectional; I <sub>P</sub> = 0 A	-	V <sub>CC</sub> × 0.5	-	V
<b>ACCURACY PERFORMANCE</b>						
Total Output Error <sup>[2]</sup>	E <sub>TOT</sub>	I <sub>P</sub> = I <sub>PR(max)</sub> , T <sub>A</sub> = 25°C to 125°C	-2.5	±0.8	2.5	%
		I <sub>P</sub> = I <sub>PR(max)</sub> , T <sub>A</sub> = -40°C to 25°C	-	±2.7	-	%
<b>TOTAL OUTPUT ERROR COMPONENTS <sup>[3]</sup>: E<sub>TOT</sub> = E<sub>SENS</sub> + 100 × V<sub>OE</sub> / (Sens × I<sub>P</sub>)</b>						
Sensitivity Error	E <sub>SENS</sub>	T <sub>A</sub> = 25°C to 125°C, measured at I <sub>P</sub> = I <sub>PR(max)</sub>	-2	±0.7	2	%
		T <sub>A</sub> = -40°C to 25°C, measured at I <sub>P</sub> = I <sub>PR(max)</sub>	-	±2.6	-	%
Offset Voltage	V <sub>OE</sub>	I <sub>P</sub> = 0 A, T <sub>A</sub> = 25°C to 125°C	-15	±7	15	mV
		I <sub>P</sub> = 0 A, T <sub>A</sub> = -40°C to 25°C	-	±15	-	mV
<b>LIFETIME DRIFT CHARACTERISTICS</b>						
Sensitivity Error Lifetime Drift	E <sub>sens_drift</sub>		-	±1	-	%
Total Output Error Lifetime Drift	E <sub>tot_drift</sub>		-	±1	-	%

<sup>[1]</sup> Typical values with +/- are 3 sigma values.

<sup>[2]</sup> Percentage of I<sub>P</sub>, with I<sub>P</sub> = I<sub>PR(max)</sub>.

<sup>[3]</sup> A single part will not have both the maximum/minimum sensitivity error and maximum/minimum offset voltage, as that would violate the maximum/minimum total output error specification. Also, 3 sigma distribution values are combined by taking the square root of the sum of the squares. See Application Information section.



xKMATR-30AU PERFORMANCE CHARACTERISTICS:  $T_A$  Range K, valid at  $T_A = -40^\circ\text{C}$  to  $125^\circ\text{C}$ ,  $V_{CC} = 5\text{ V}$ , unless otherwise specified

Characteristic	Symbol	Test Conditions	Min.	Typ. <sup>[1]</sup>	Max.	Units
<b>NOMINAL PERFORMANCE</b>						
Current Sensing Range	$I_{PR}$		0	–	30	A
Sensitivity	Sens	$I_{PR(\min)} < I_P < I_{PR(\max)}$	–	132	–	mV/A
Zero Current Output Voltage	$V_{IOUT(Q)}$	Unidirectional; $I_P = 0\text{ A}$	–	$V_{CC} \times 0.1$	–	V
<b>ACCURACY PERFORMANCE</b>						
Total Output Error <sup>[2]</sup>	$E_{TOT}$	$I_P = I_{PR(\max)}$ , $T_A = 25^\circ\text{C}$ to $125^\circ\text{C}$	–2.5	$\pm 0.7$	2.5	%
		$I_P = I_{PR(\max)}$ , $T_A = -40^\circ\text{C}$ to $25^\circ\text{C}$	–	$\pm 2.5$	–	%
<b>TOTAL OUTPUT ERROR COMPONENTS <sup>[3]</sup>: <math>E_{TOT} = E_{SENS} + 100 \times V_{OE} / (\text{Sens} \times I_P)</math></b>						
Sensitivity Error	$E_{SENS}$	$T_A = 25^\circ\text{C}$ to $125^\circ\text{C}$ , measured at $I_P = I_{PR(\max)}$	–2	$\pm 0.7$	2	%
		$T_A = -40^\circ\text{C}$ to $25^\circ\text{C}$ , measured at $I_P = I_{PR(\max)}$	–	$\pm 2.5$	–	%
Offset Voltage	$V_{OE}$	$I_P = 0\text{ A}$ , $T_A = 25^\circ\text{C}$ to $125^\circ\text{C}$	–15	$\pm 7$	15	mV
		$I_P = 0\text{ A}$ , $T_A = -40^\circ\text{C}$ to $25^\circ\text{C}$	–	$\pm 20$	–	mV
<b>Lifetime Drift Characteristics</b>						
Sensitivity Error Lifetime Drift	$E_{\text{sens\_drift}}$		–	$\pm 1$	–	%
Total Output Error Lifetime Drift	$E_{\text{tot\_drift}}$		–	$\pm 1$	–	%

<sup>[1]</sup> Typical values with +/- are 3 sigma values.

<sup>[2]</sup> Percentage of  $I_P$ , with  $I_P = I_{PR(\max)}$ .

<sup>[3]</sup> A single part will not have both the maximum/minimum sensitivity error and maximum/minimum offset voltage, as that would violate the maximum/minimum total output error specification. Also, 3 sigma distribution values are combined by taking the square root of the sum of the squares. See Application Information section.

xKMATR-65AB PERFORMANCE CHARACTERISTICS:  $T_A$  Range K, valid at  $T_A = -40^\circ\text{C}$  to  $125^\circ\text{C}$ ,  $V_{CC} = 5\text{ V}$ , unless otherwise specified

Characteristic	Symbol	Test Conditions	Min.	Typ. <sup>[1]</sup>	Max.	Units
<b>NOMINAL PERFORMANCE</b>						
Current Sensing Range	$I_{PR}$		-65	-	65	A
Sensitivity	Sens	$I_{PR(\min)} < I_P < I_{PR(\max)}$	-	30.75	-	mV/A
Zero Current Output Voltage	$V_{IOUT(Q)}$	Bidirectional; $I_P = 0\text{ A}$	-	$V_{CC} \times 0.5$	-	V
<b>ACCURACY PERFORMANCE</b>						
Total Output Error <sup>[2]</sup>	$E_{TOT}$	$I_P = I_{PR(\max)}$ , $T_A = 25^\circ\text{C}$ to $125^\circ\text{C}$	-2.5	$\pm 1$	2.5	%
		$I_P = I_{PR(\max)}$ , $T_A = -40^\circ\text{C}$ to $25^\circ\text{C}$	-	$\pm 3$	-	%
<b>TOTAL OUTPUT ERROR COMPONENTS <sup>[3]</sup>: <math>E_{TOT} = E_{SENS} + 100 \times V_{OE} / (\text{Sens} \times I_P)</math></b>						
Sensitivity Error	$E_{SENS}$	$T_A = 25^\circ\text{C}$ to $125^\circ\text{C}$ , measured at $I_P = I_{PR(\max)}$	-2	$\pm 1$	2	%
		$T_A = -40^\circ\text{C}$ to $25^\circ\text{C}$ , measured at $I_P = I_{PR(\max)}$	-	$\pm 2.8$	-	%
Offset Voltage	$V_{OE}$	$I_P = 0\text{ A}$ , $T_A = 25^\circ\text{C}$ to $125^\circ\text{C}$	-15	$\pm 5$	15	mV
		$I_P = 0\text{ A}$ , $T_A = -40^\circ\text{C}$ to $25^\circ\text{C}$	-	$\pm 20$	-	mV
<b>LIFETIME DRIFT CHARACTERISTICS</b>						
Sensitivity Error Lifetime Drift	$E_{\text{sens\_drift}}$		-	$\pm 1$	-	%
Total Output Error Lifetime Drift	$E_{\text{tot\_drift}}$		-	$\pm 1$	-	%

<sup>[1]</sup> Typical values with +/- are 3 sigma values.

<sup>[2]</sup> Percentage of  $I_P$ , with  $I_P = I_{PR(\max)}$ .

<sup>[3]</sup> A single part will not have both the maximum/minimum sensitivity error and maximum/minimum offset voltage, as that would violate the maximum/minimum total output error specification. Also, 3 sigma distribution values are combined by taking the square root of the sum of the squares. See Application Information section.

## CHARACTERISTIC PERFORMANCE xKMATR-12AB

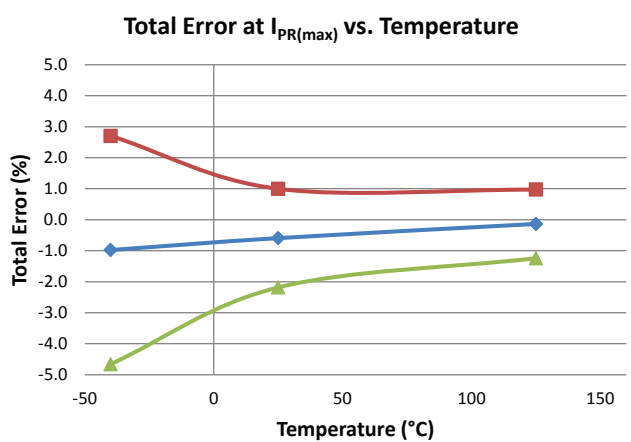
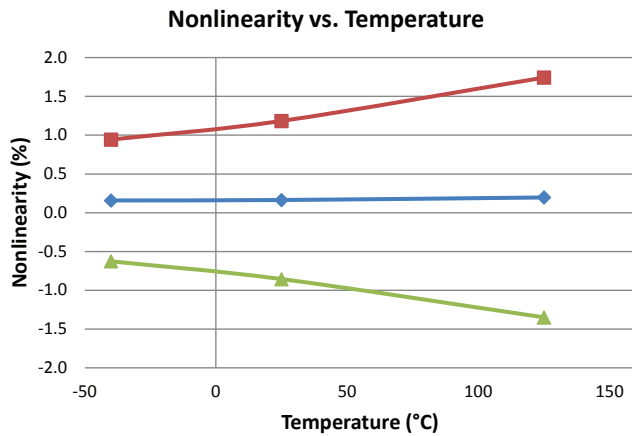
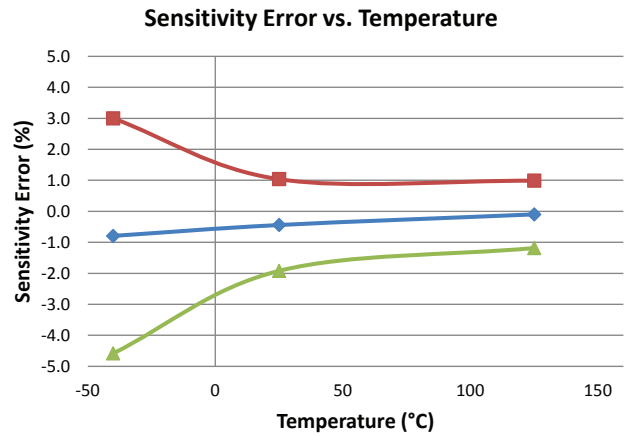
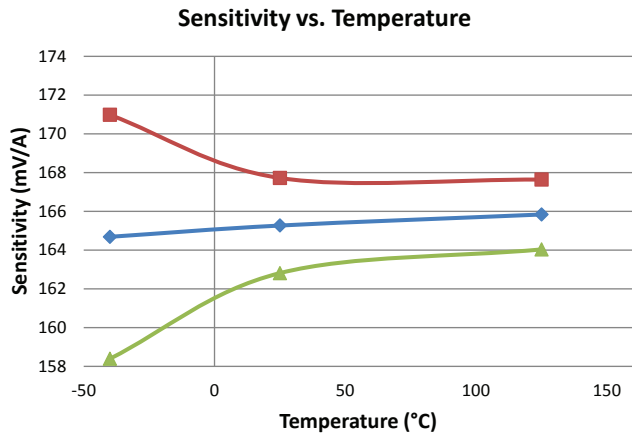
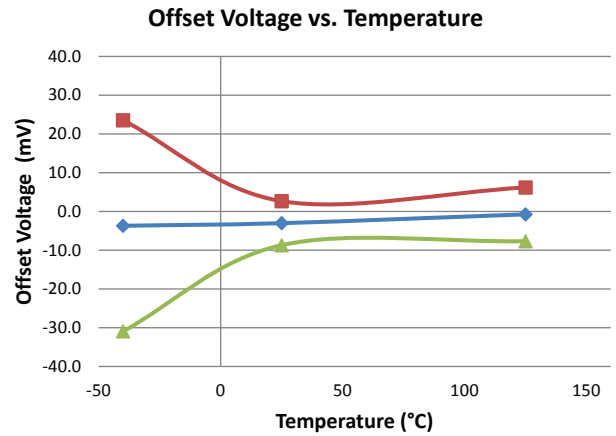
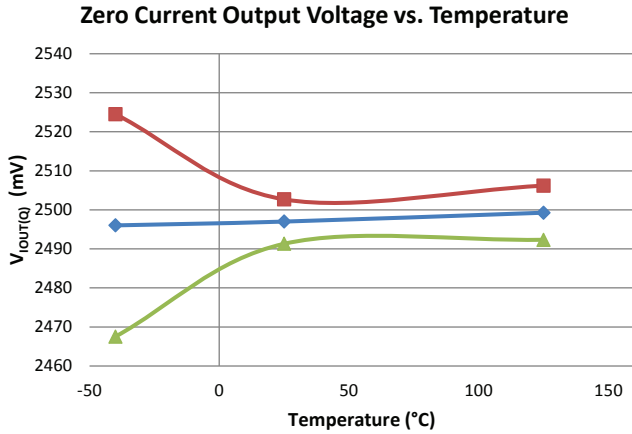

■ +3 Sigma     
 ◆ Average     
 ▲ -3 Sigma

## CHARACTERISTIC PERFORMANCE xKMATR-20AB

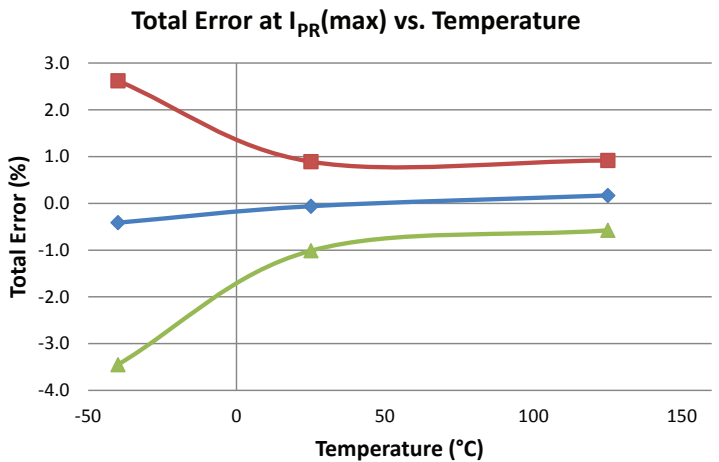
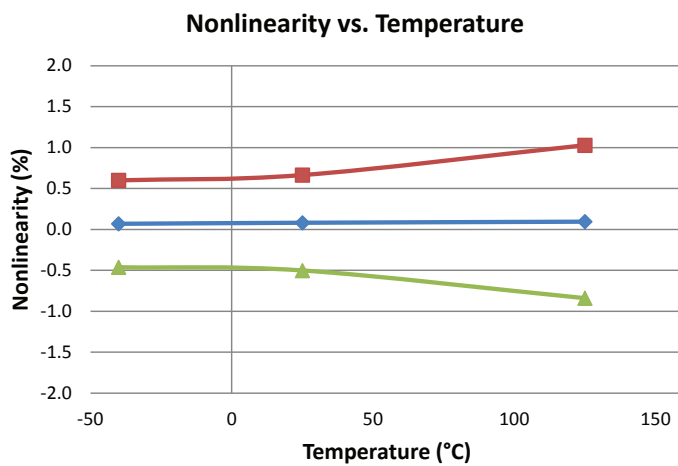
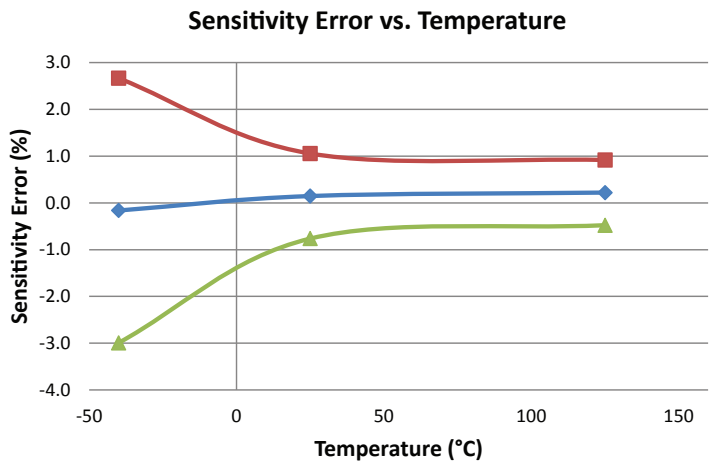
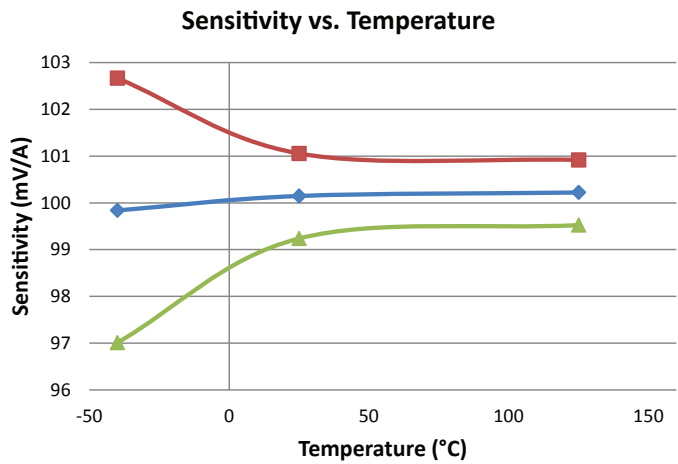
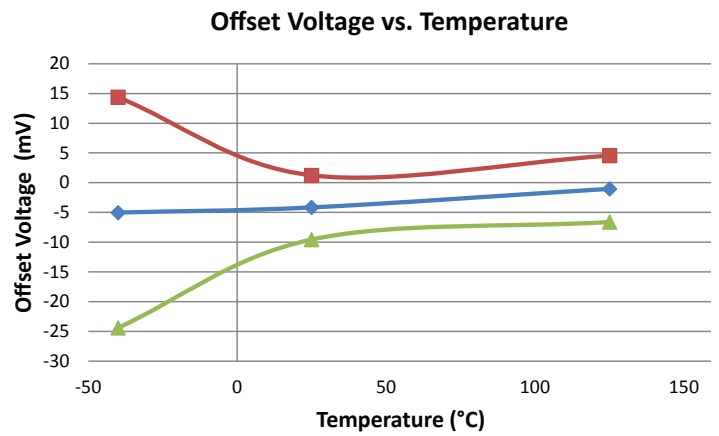
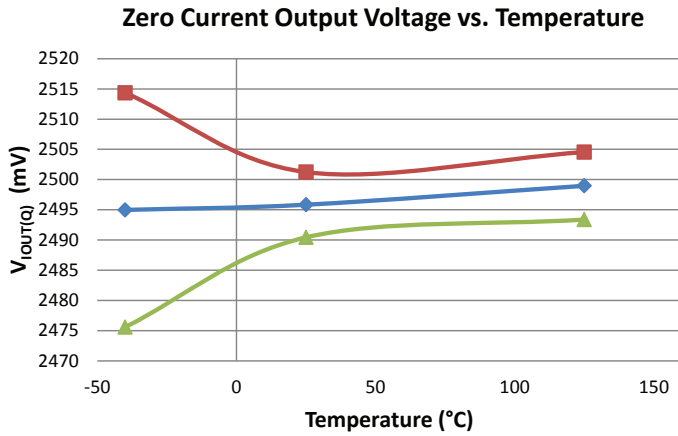

■ +3 Sigma     
 ◆ Average     
 ▲ -3 Sigma

## CHARACTERISTIC PERFORMANCE xKMATR-30AB

Zero Current Output Voltage vs. Temperature

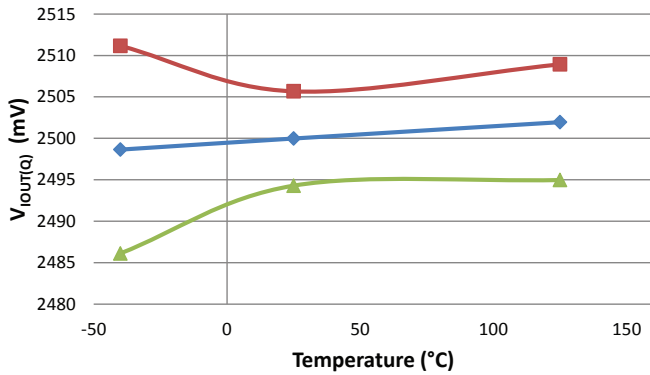

Offset Voltage vs. Temperature

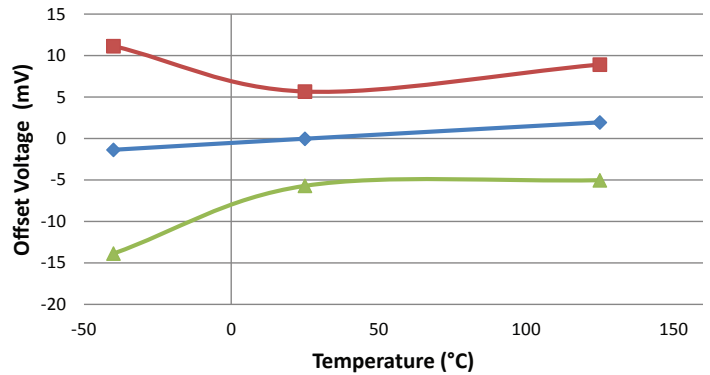

Sensitivity vs. Temperature

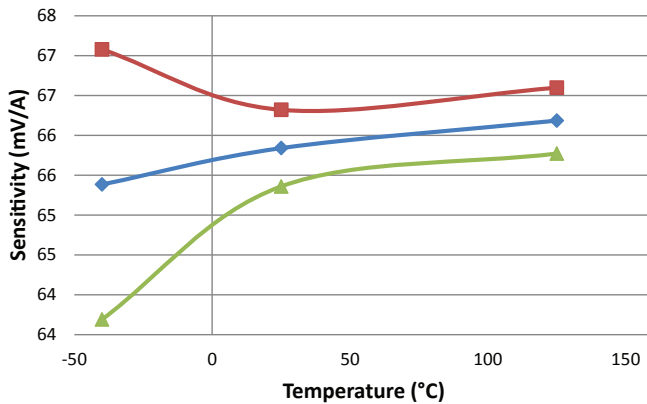

Sensitivity Error vs. Temperature

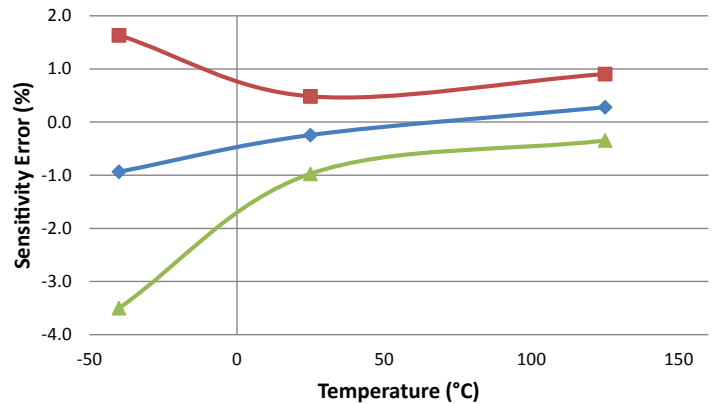

Nonlinearity vs. Temperature

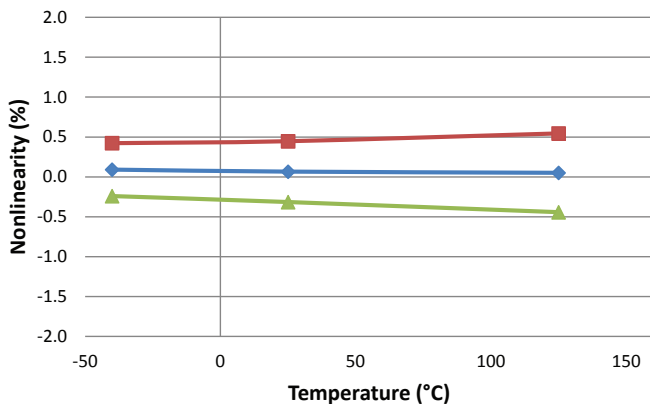

Total Error at  $I_{PR(max)}$  vs. Temperature

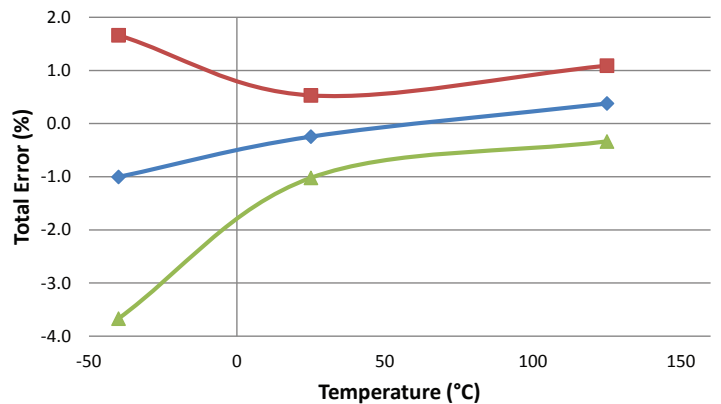

■ +3 Sigma     
 ◆ Average     
 ▲ -3 Sigma

## CHARACTERISTIC PERFORMANCE xKMATR-30AU

### Zero Current Output Voltage vs. Temperature

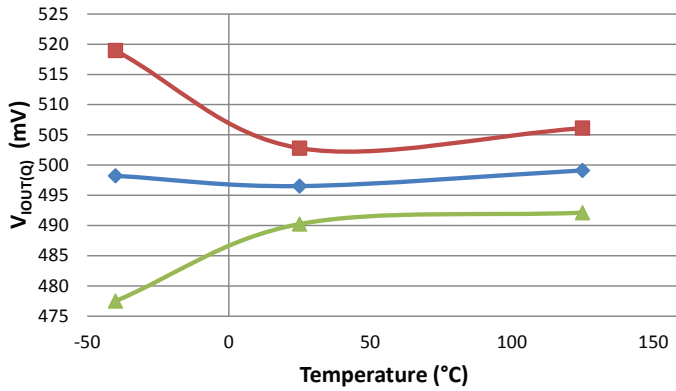

### Offset Voltage vs. Temperature

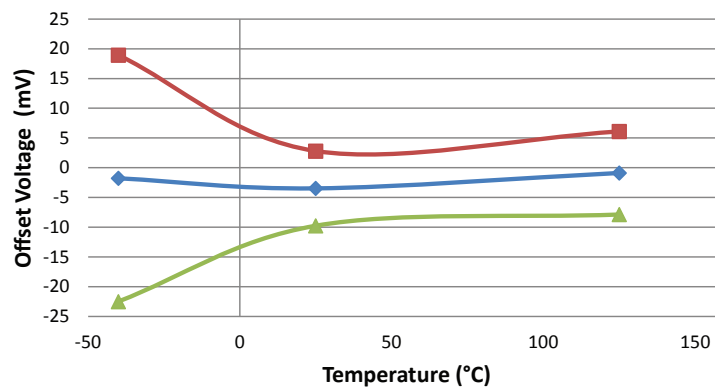

### Sensitivity vs. Temperature

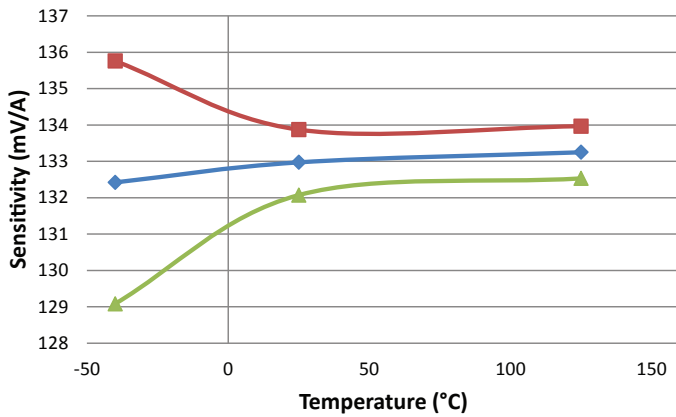

### Sensitivity Error vs. Temperature

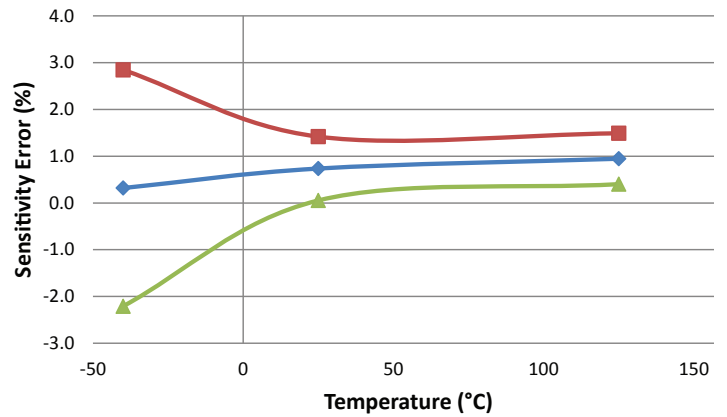

### Nonlinearity vs. Temperature

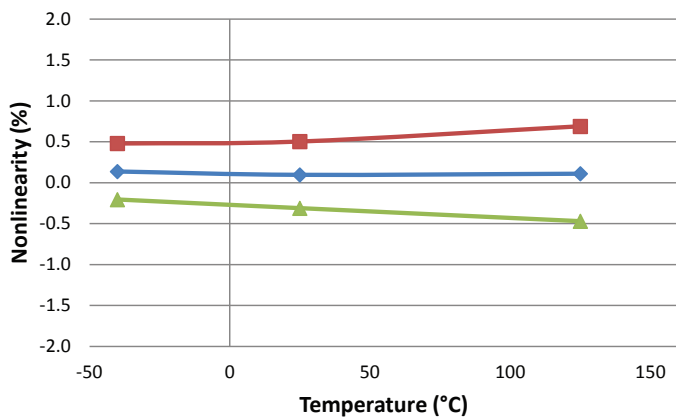

### Total Error at I<sub>PR</sub>(max) vs. Temperature

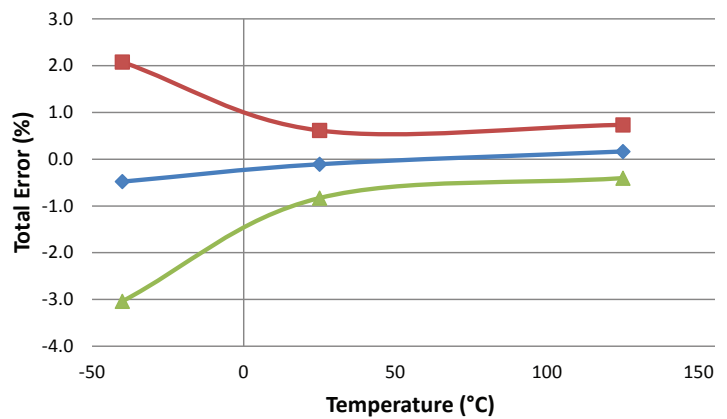

■ +3 Sigma     
 ◆ Average     
 ▲ -3 Sigma

### DEFINITIONS OF ACCURACY CHARACTERISTICS

#### Sensitivity (Sens)

The change in sensor IC output in response to a 1 A change through the primary conductor. The sensitivity is the product of the magnetic coupling factor (G/A) (1 G = 0.1 mT) and the linear IC amplifier gain (mV/G). The linear IC amplifier gain is programmed at the factory to optimize the sensitivity (mV/A) for the full-scale current of the device.

#### Nonlinearity ( $E_{LIN}$ )

The nonlinearity is a measure of how linear the output of the sensor IC is over the full current measurement range. The nonlinearity is calculated as:

$$E_{LIN} = \left\{ 1 - \left[ \frac{V_{IOUT}(I_{PR(max)}) - V_{IOUT(Q)}}{2 \times V_{IOUT}(I_{PR(max)/2}) - V_{IOUT(Q)}} \right] \right\} \times 100 (\%)$$

where  $V_{IOUT}(I_{PR(max)})$  is the output of the sensor IC with the maximum measurement current flowing through it and  $V_{IOUT}(I_{PR(max)/2})$  is the output of the sensor IC with half of the maximum measurement current flowing through it.

#### Zero Current Output Voltage ( $V_{IOUT(Q)}$ )

The output of the sensor when the primary current is zero. For a unipolar supply voltage, it nominally remains at  $0.5 \times V_{CC}$  for a bidirectional device and  $0.1 \times V_{CC}$  for a unidirectional device. For example, in the case of a bidirectional output device,  $V_{CC} = 5.0 \text{ V}$  translates into  $V_{IOUT(Q)} = 2.50 \text{ V}$ . Variation in  $V_{IOUT(Q)}$  can be attributed to the resolution of the Allegro linear IC quiescent voltage trim and thermal drift.

#### Offset Voltage ( $V_{OE}$ )

The deviation of the device output from its ideal quiescent value of  $0.5 \times V_{CC}$  (bidirectional) or  $0.1 \times V_{CC}$  (unidirectional) due to nonmagnetic causes. To convert this voltage to amperes, divide by the device sensitivity, Sens.

#### Total Output Error ( $E_{TOT}$ )

The difference between the current measurement from the sensor IC and the actual current ( $I_P$ ), relative to the actual current. This is equivalent to the difference between the ideal output voltage and the actual output voltage, divided by the ideal sensitivity, relative to the current flowing through the primary conduction path:

$$E_{TOT}(I_P) = \frac{V_{IOUT\_ideal}(I_P) - V_{IOUT}(I_P)}{\text{Sens}_{ideal}(I_P) \times I_P} \times 100 (\%)$$

The Total Output Error incorporates all sources of error and is a function of  $I_P$ . At relatively high currents,  $E_{TOT}$  will be mostly due to

sensitivity error, and at relatively low currents,  $E_{TOT}$  will be mostly due to Offset Voltage ( $V_{OE}$ ). In fact, at  $I_P = 0$ ,  $E_{TOT}$  approaches infinity due to the offset. This is illustrated in Figure 1 and Figure 2. Figure 1 shows a distribution of output voltages versus  $I_P$  at 25°C and across temperature. Figure 2 shows the corresponding  $E_{TOT}$  versus  $I_P$ .

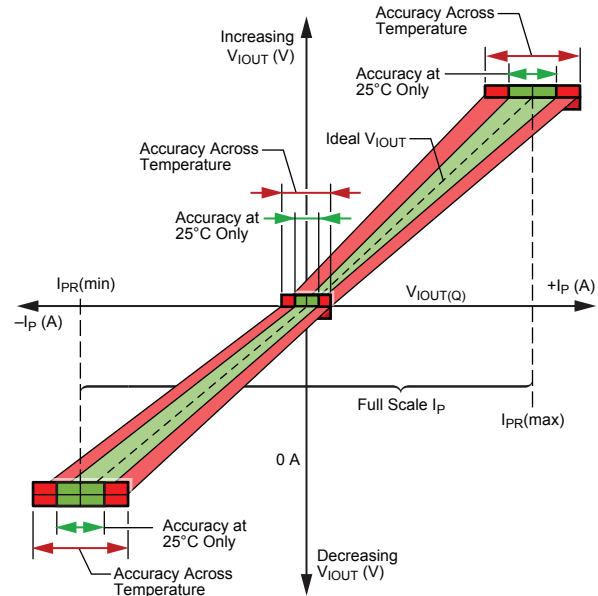

Figure 1: Output Voltage versus Sensed Current

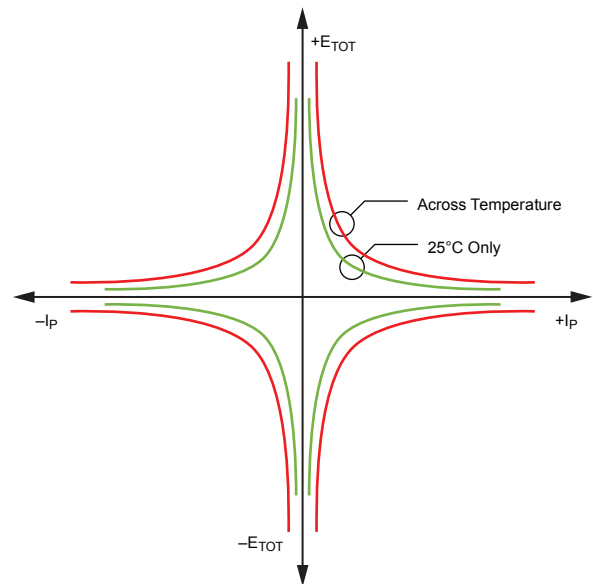

Figure 2: Total Output Error versus Sensed Current

### APPLICATION INFORMATION

#### Estimating Total Error versus Sensed Current

The Performance Characteristics tables give distribution ( $\pm 3$  sigma) values for Total Error at  $I_{PR(max)}$ ; however, one often wants to know what error to expect at a particular current. This can be estimated by using the distribution data for the components of Total Error, Sensitivity Error, and Offset Voltage. The  $\pm 3$  sigma value for Total Error ( $E_{TOT}$ ) as a function of the sensed current ( $I_p$ ) is estimated as:

$$E_{TOT}(I_p) = \sqrt{E_{SENS}^2 + \left(\frac{100 \times V_{OE}}{Sens \times I_p}\right)^2}$$

Here,  $E_{SENS}$  and  $V_{OE}$  are the  $\pm 3$  sigma values for those error terms. If there is an average sensitivity error or average offset voltage, then the average Total Error is estimated as:

$$E_{TOT,AVG}(I_p) = E_{SENS,AVG} + \frac{100 \times V_{OE,AVG}}{Sens \times I_p}$$

The resulting total error will be a sum of  $E_{TOT}$  and  $E_{TOT,AVG}$ . Using these equations and the 3 sigma distributions for Sensitivity Error and Offset Voltage, the Total Error versus sensed current ( $I_p$ ) is shown here for the ACS724KMATR-20AB. As expected, as one goes towards zero current, the error in percent goes towards infinity due to division by zero (refer to Figure 3).

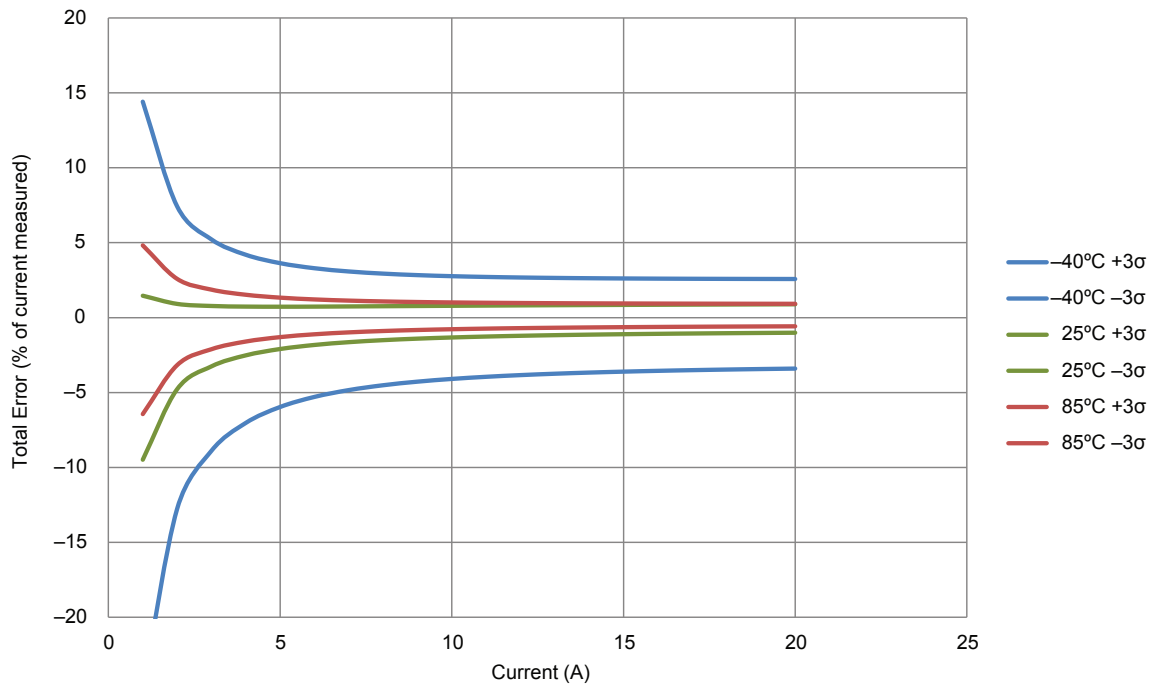

Figure 3: Predicted Total Error as a Function of Sensed Current for the ACS724KMATR-20AB



### DEFINITIONS OF DYNAMIC RESPONSE CHARACTERISTICS

#### Power-On Time ( $t_{PO}$ )

When the supply is ramped to its operating voltage, the device requires a finite time to power its internal components before responding to an input magnetic field.

Power-On Time ( $t_{PO}$ ) is defined as the time it takes for the output voltage to settle within  $\pm 10\%$  of its steady-state value under an applied magnetic field, after the power supply has reached its minimum specified operating voltage ( $V_{CC(min)}$ ) as shown in the chart at right (refer to Figure 4).

#### Rise Time ( $t_r$ )

The time interval between: a) when the sensor IC reaches 10% of its full-scale value; and b) when it reaches 90% of its full-scale value (refer to Figure 5). The rise time to a step response is used to derive the bandwidth of the current sensor IC, in which  $f(-3 \text{ dB}) = 0.35/t_r$ . Both  $t_r$  and  $t_{RESPONSE}$  are detrimentally affected by eddy current losses observed in the conductive IC ground plane.

#### Propagation Delay ( $t_{pd}$ )

The propagation delay is measured as the time interval between: a) when the primary current signal reaches 20% of its final value, and b) when the device reaches 20% of its output corresponding to the applied current (refer to Figure 5).

#### Response Time ( $t_{RESPONSE}$ )

The time interval between: a) when the primary current signal reaches 90% of its final value, and b) when the device reaches 90% of its output corresponding to the applied current (refer to Figure 6).

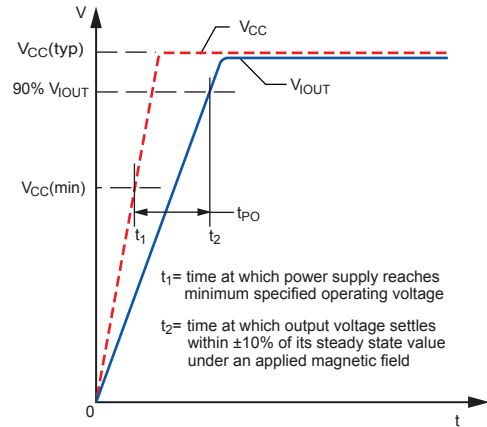

Figure 4: Power-On Time

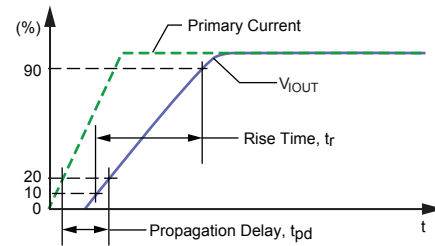

Figure 5: Rise Time and Propagation Delay

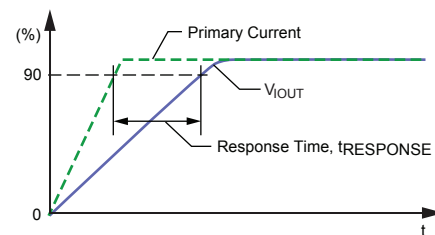

Figure 6: Response Time

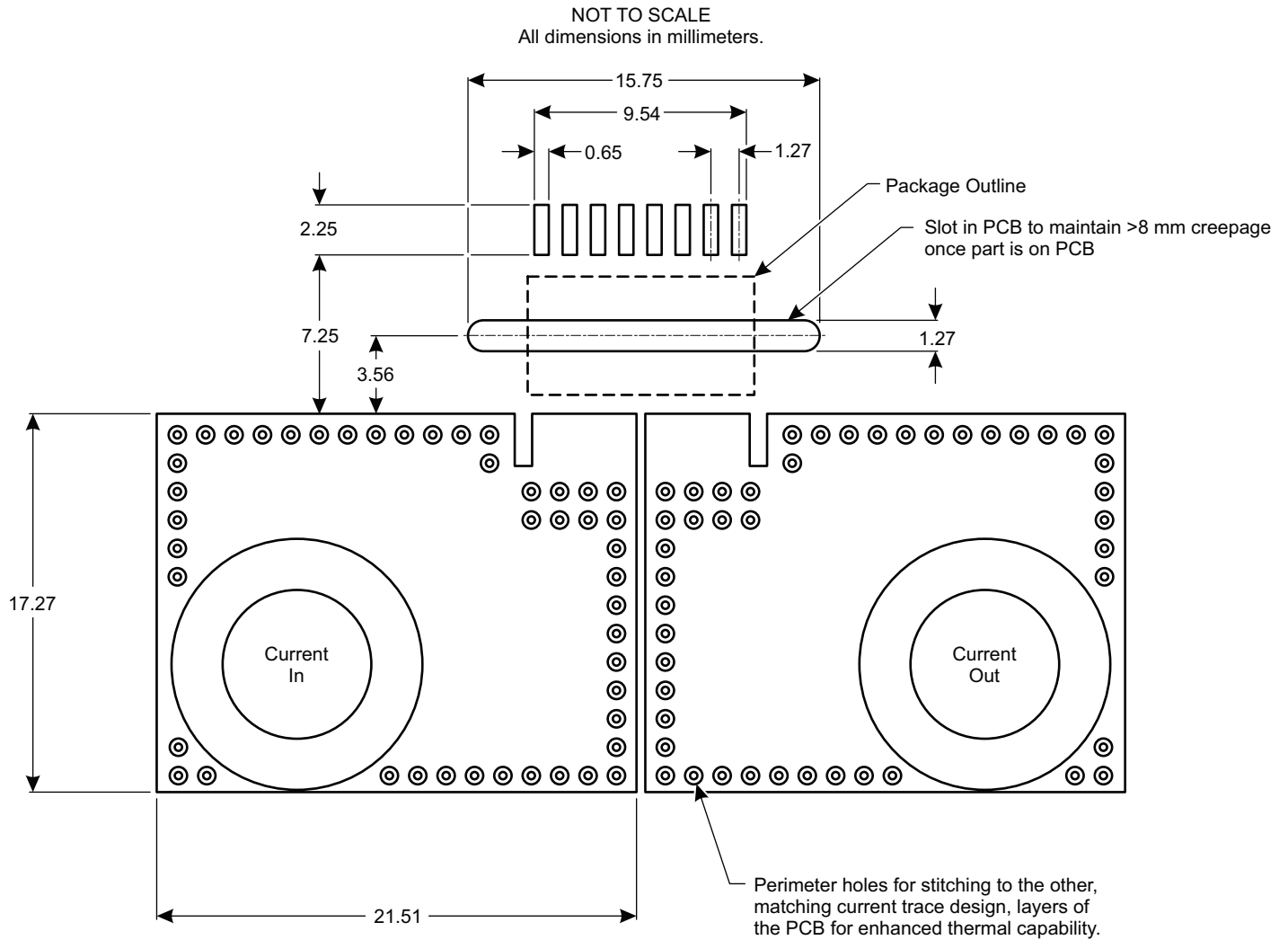

Figure 7: High-Isolation PCB Layout

### PACKAGE OUTLINE DRAWING

#### For Reference Only – Not for Tooling Use

(Reference MS-013AA)

NOT TO SCALE

Dimensions in millimeters

Dimensions exclusive of mold flash, gate burrs, and dambar protrusions

Exact case and lead configuration at supplier discretion within limits shown

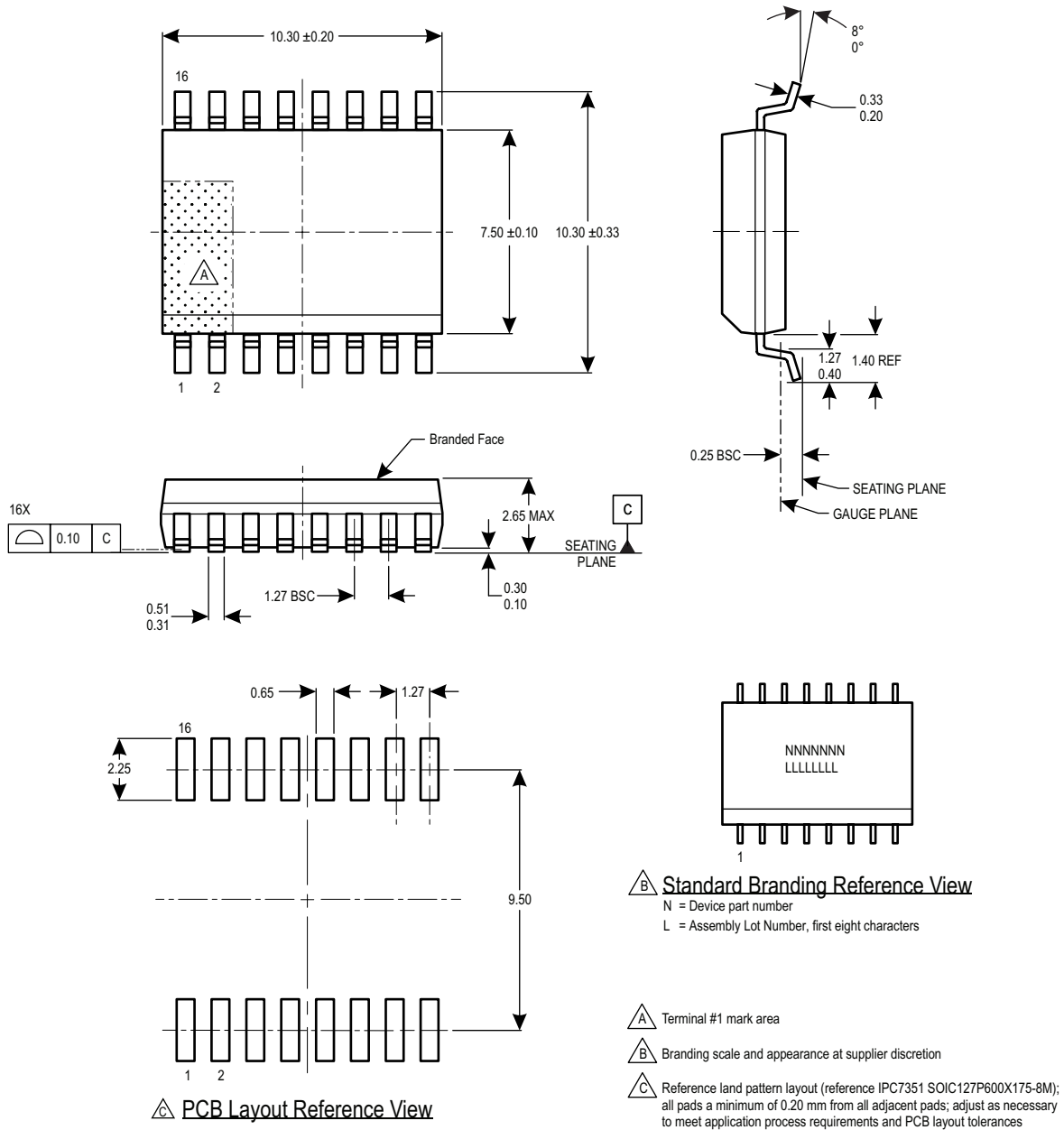

Figure 8: Package MA, 16-Pin SOICW

# ACS724KMA

## *High-Accuracy, Hall-Effect-Based Current Sensor IC with Common-Mode Field Rejection in High-Isolation SOIC16 Package*

### Revision History

Number	Date	Description
–	December 11, 2015	Initial release
1	January 8, 2016	Added ACS724KMATR-65AB-T variant
2	March 18, 2016	Added ACS724KMATR-30AB-T variant, UL/TUV certification; removed solder balls reference in Description
3	April 13, 2016	Corrected Package Outline Drawing branding information (page 17).
4	June 15, 2017	Added ACS724KMATR-12AB-T variant; corrected packing information
5	November 27, 2017	Added Sensitivity Ratiometry Coefficient and Zero-Current Output Ratiometry Coefficient to Electrical Characteristics table (page 5).

Copyright ©2017, Allegro MicroSystems, LLC

Allegro MicroSystems, LLC reserves the right to make, from time to time, such departures from the detail specifications as may be required to permit improvements in the performance, reliability, or manufacturability of its products. Before placing an order, the user is cautioned to verify that the information being relied upon is current.

Allegro's products are not to be used in any devices or systems, including but not limited to life support devices or systems, in which a failure of Allegro's product can reasonably be expected to cause bodily harm.

The information included herein is believed to be accurate and reliable. However, Allegro MicroSystems, LLC assumes no responsibility for its use; nor for any infringement of patents or other rights of third parties which may result from its use.

*For the latest version of this document, visit our website:*

[www.allegromicro.com](http://www.allegromicro.com)

