

RoHS

客户图

由 Autodesk 教育版产品制作

目錄
MAPX
A0

设变内容
MODIFICATION
NEW

日期
DATE
09-10-20

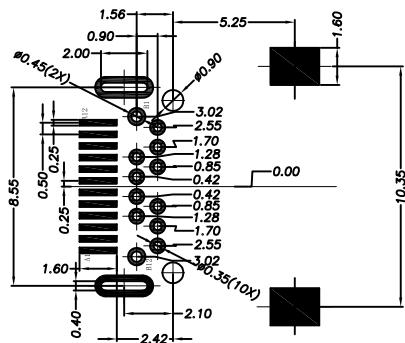
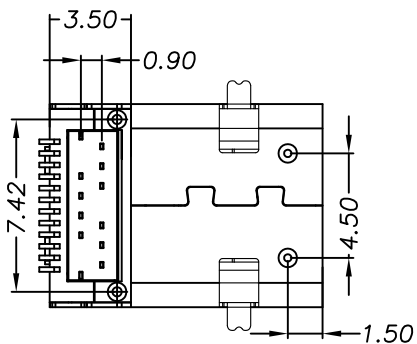
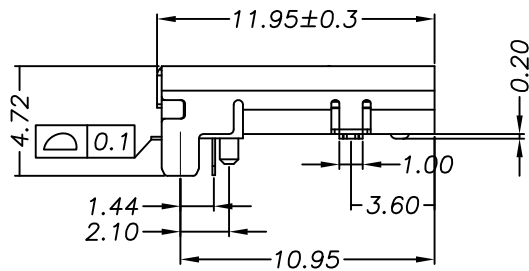
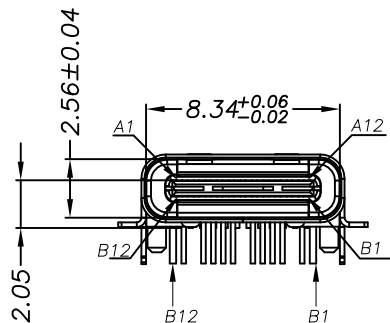
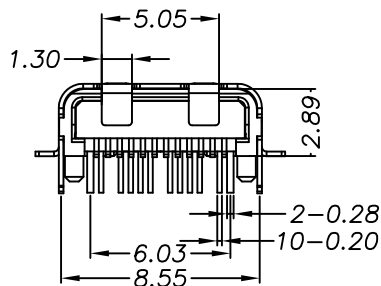
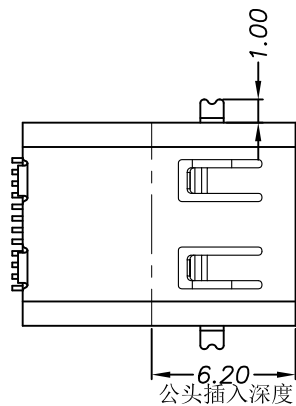
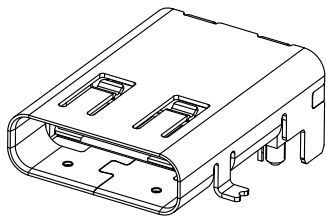

RECOMMENDED PCB LAYOUT(TOP VIEW)

NOTES:

SPECIFICATION:

- CURRENT RATING: 3A MAX
- VOLTAGE: 100 VAC
- TEMPERATURE RANGE: -30 °C ~ 85 °C
- CONTACT RESISTANCE: 40 MILLIONHM MAX
- INSULATION RESISTANCE: 100 MEGOHMS MIN.
- INSERTION FORCE : 5N~20N
- UNMATING FORCE: 8N~20N
- DURABILITY: 10,000 CYCLES

A1	GND	B12	GND
A2	SSTXP1	B11	SSRXP1
A3	SSTXN1	B10	SSRXN1
A4	VBUS	B9	VBUS
A5	CC1	B8	SBU2
A6	DP1	B7	DN2
A7	DN1	B6	DP2
A8	SBU1	B5	CC2
A9	VBUS	B4	VBUS
A10	SSRXN2	B3	SSTXN2
A11	SSRXP2	B2	SSTXP2
A12	GND	B1	GND
PIN	SIGNAL NAME	PIN	SIGNAL NAME

产品图

PRODUCT CHART DWG

深圳市精拓金电子有限公司

公差一览表

TOLERANCE UNLESS OTHERWISE			
X.	±0.30	X'.	±5°
.X	±0.25	.X'	±2°
.XX	±0.30	.XX'	±1°
.XXX	±0.15	.XXX'	±0.5°

单位 UNITS	MM	制图 DRAWING	许榕强	产品料号 PRODUCT PART NO.	918-418K2023C40004
比例 SCALE	1:1	审核 CHKD	郭治富	产品名称 PRODUCT NO.	TYPE-C3.1母座11.95L/8.55四脚前贴后插LCP黑有柱端子DIP+SMT24P
日期 DATE	2009/10/20	核准 APPD	黄国荣	角法 VIEW	版本 VER A0

由 Autodesk 教育版产品制作

由 Autodesk 教育版产品制作