

IT6720 Digital Control Power Supply

User 's Manual



Access www.itechate.com for more products information

WARNING

Safety Regulations

To avoid electrical shock, do not open the cabinet. Refer servicing to qualified personnel only.

To avoid injuries, always disconnect power, discharge circuits, and remove external voltage sources before touching components. **KEEP AWAY FROM LIVE CIRCUITS.**

We cannot accept responsibility for any direct or indirect financial damage or loss of profit that might occur when using the power supply.

The instrument chassis and cover must be connected to an electrical ground.

Certification

We certify that this product met its published specifications at time of shipment from the factory.

Notice

The information contained in this document is subject to change without notice.

Warranty

This hardware product is warranted against defects in material and workmanship for a period of ONE year from date of delivery. IT6720 power supply for use with a hardware product and when properly installed on that hardware product, are warranted not to fail to execute their programming instructions due to defects in material and workmanship for a period of 90 days from date of delivery. During the warranty period our company will either repair or replace products which prove to be defective. Our company does not warranty that the operation for the software firmware or hardware shall be uninterrupted or error free. For warranty service, with the exception of warranty options, this product must be returned to a service facility designated by our company. Customer shall prepay shipping charges by (and shall pay all duty and taxes) for products returned to our place for warranty service. Our company shall pay for return of products to Customer.

Limitation of Warranty

The foregoing warranty shall not apply to defects resulting from improper or inadequate maintenance by the customer, customer-supplied software or interfacing, unauthorized modification or misuse, operation outside of the environmental specifications for the product, or improper site preparation and maintenance.

Compliance Statements

Disposal of Old Electrical & Electronic Equipment (Applicable in the European Union and other European countries with separate collection systems)



The ITECH product you have purchased is subject to Directive 2002/96/EC of the European Parliament and the Council of the European Union on waste electrical and electronic equipment (WEEE) and, in jurisdictions adopting that Directive, is marked as being put on the market after August 13, 2005, and should not be disposed of as unsorted municipal waste. Please utilize your local WEEE collection facilities in the disposition of this product and otherwise observe all applicable requirements.

Safety Symbols



Connect it to safety earth ground using the wire recommended in the user's manual.



High voltage danger



The symbol on an instrument indicates that the user should refer to the operating instructions located in the manual.

About IT6720

With widest voltage and current range, IT6720 digital DC power supplies are applied in many fields.

With max power 100W and output adjustable in 60V/5A, auto control voltage/current slew rate, power rate up to three times rapid than other similar products, a unit can replace three models (60V*1.6A/ 32V*3A/ 20V*5A), reduce your repeat investment.

Example:

When you set the output voltage as 60V, because the max power of IT6720 is 100W, so the max output current is $100W/60V=1.6A$.

When you change the output voltage to 30V, the output current is $100W/30V=3.2A$.

Calculate according to the above way when the output voltage is 20V, the output current should be 5A, but as the max rating current of IT6720 is 8A, so the final max output current is 5A.

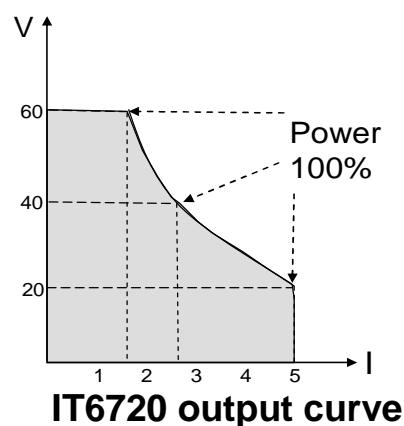

■ Function

- Fully digital control
- High resolution 10mV/1mA in Full range
- Low ripple and noise
- Software calibration
- Bright and easy to read display (VFD)
- Constant current and constant voltage output
- Selectable remote control keypads
- High reliability OVP/OCP/OTP protection
- Output on/off control
- Best performance /price ratio
- Storage for 4*100 preset voltage and current output

Panel Layout

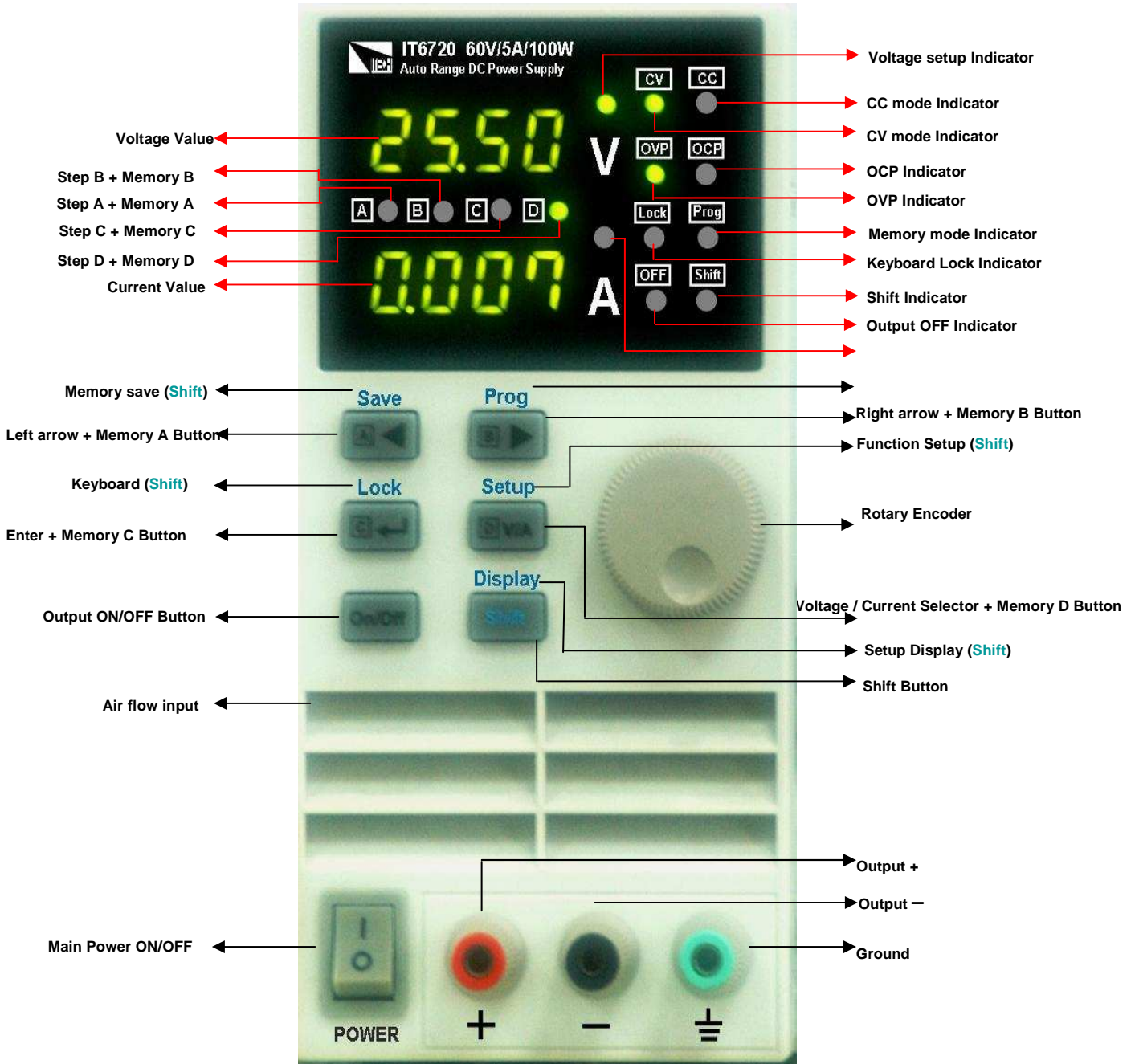

Quick Start

Check out

Confirm whether the power supply has been destroyed in transportation, if there is any flaw, please contact the vender.





Confirm whether the AC input voltage of IT6720 comply with the standards of your country or region.

Note: If switching input voltage, operate through the back panel switch (110V/220V).

After the check of the above matters, power on by press 

Setting the voltage



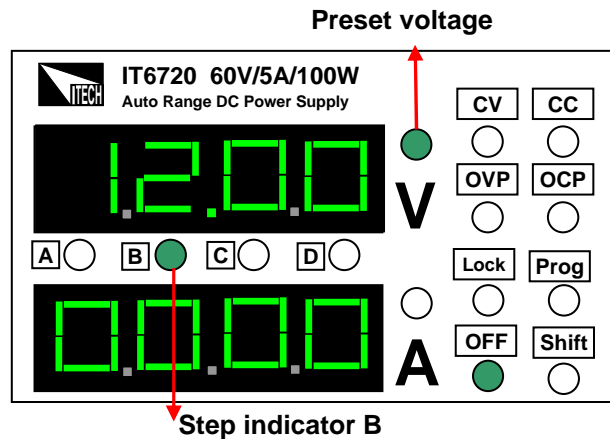

Press  to light up the voltage setup indicator B. It means IT6720 is in voltage set mode, shown as fig 1.

Press   light up the voltage setup indicator . Now the voltage will rise/decline 1V once you rotary the knob . Set the voltage to 12V.





Setting the current

Press  to light up the current setup indicator A. IT6720 is in current set mode, shown as fig 1.

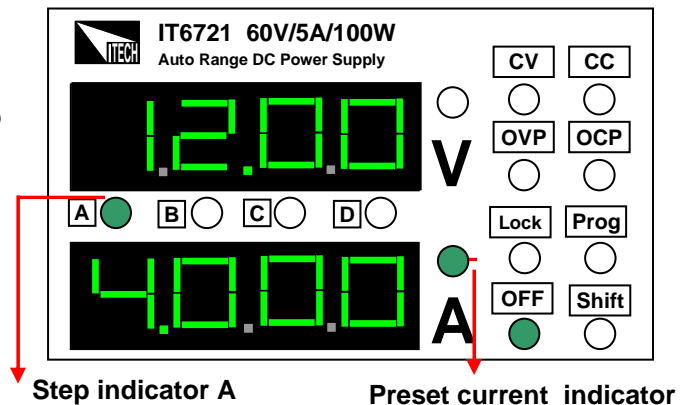
Press   to adjust the setup indicator to . Now the current will rise/decline 1V once you rotary the knob . Set the current to 4A.



Enable output

Press  to enable the IT6720 output. Voltage and current settings will be wink for three seconds, and after that, the display value of numerical display will change from the set value to actual measured voltage and current value. Power off lights will be turned off which means the power is in output state. Press  again, you will shut power supply's output.

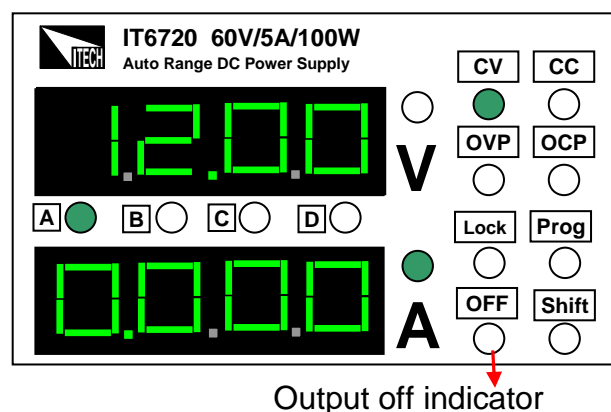

Step value for Cursor Position

Cursor position	Step voltage	Step current
A	-----	1A
B	1V	0.1A
C	0.1V	0.01A
D	0.01V	0.001A

Check the set voltage and current value

The power supply usually displays the actual voltage and current values. When you want to check the preset voltage and current values, the unit will display automatically settings, press **Shift** twice, the settings will be displayed for three seconds.

Key lock function

This function can prevent error operation by unauthorized person.

Press **Shift**, after the **Shift** was lit on, press **Lock** (Lock), **Lock** will be lit on, which means all keys on the panel except **Shift** and **On/Off**. Repeat above operation, key lock function will be disabled.

OVP function

Press **Shift**, and press **D/V/A** for three seconds, now the panel displays OVP, shown as fig 4. Use **A**, **B** and **Rotary** to set OVP value.

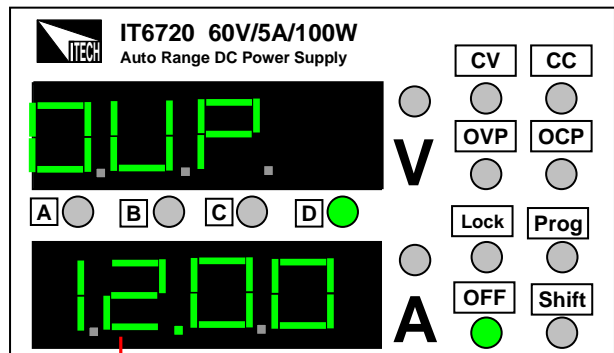

OVP voltage value

OCP function

Press **Lock** to enter into OCP setting interface after setting OVP value, use **A**, **B** and **Rotary** to set the OCP value.

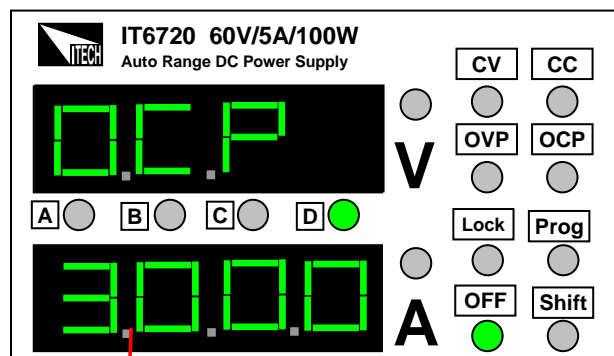

NOTE

If the OVP and OCP settings are lower than the actual voltage/current value, the output of power supply will be turned off. The default settings of IT6720 are OVP=61V, OCP=5.1A.





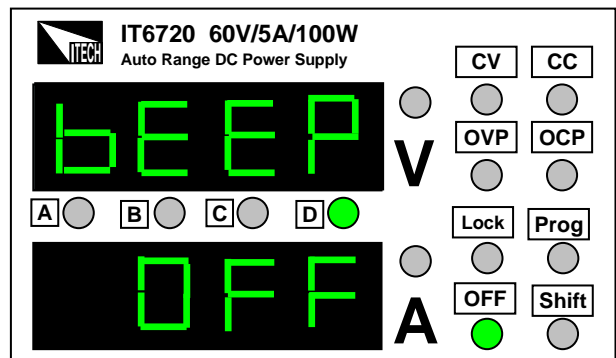

OCP current value

Key sound (BEEP)

Press  to enter the BEEP setting Interface after finished the OCP setting, select the ON/OFF state with the knob . ON indicates there is key sound, OFF means no.





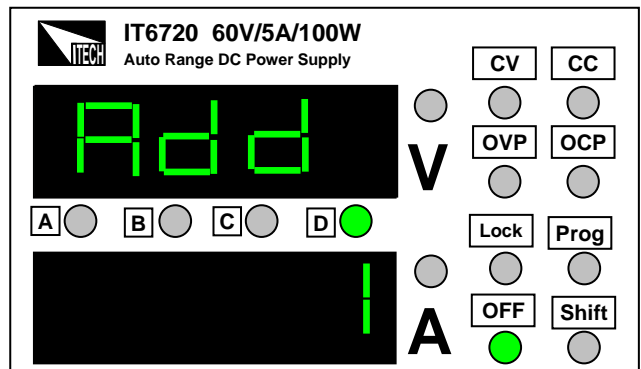

Power address (ADD)

Press  to enter the ADD setting interface after finishing the BEEP setting, select the   and  to enter store address setting. ADD range: 0~30, press  to confirm.



Store group setting (GRP)

Press  to enter into GRP interface after setting the OCP value, use   and  to select store group.

IT6720 allows customers to store 100 groups with A/B/C/D four set value for every group.

Press  to confirm the chosen group and end the setup mode.

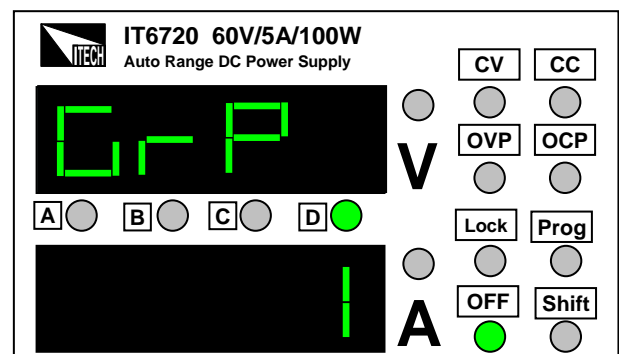

Store operation

In the normal working mode, set the voltage/current value to be stored.

Press **Shift** and **A** , now the Cursor **A** **B** **C** **D** will wink together. Press any key in **A** **B** **C** **D** to save it.

Recall operation

Press **Shift** and **B** , the indicator **Prog** will be lit on, which means that IT6720 working in the shortcuts mode. Press any key in **A** **B** **C** **D** , recall the preset voltage/current value which has been stored.

When the power supply is on recall operation, that means all you can recall the parameters from the store group. Press any key of **A** **B** **C** **D** to recall the stored parameter.

When the power supply is on recall operation **A** **B** **C** **D** are disabled, they only can be used with **Shift** key. Press **Shift** , and press **B** to exit recall function.CC

Faulty disposal

If the outputs is disabled:

1: Check whether voltage and current settings are zero, if so, reset voltage and current value.

2: Check whether the indicator **OFF** is lit on, if so, press **On/Off** to enable the outputs.

3: Check whether the indicators **OVP** **OCP** are lit on, if so, please reset according to the mentioned OVP/OCP/OCP means.

If the keypad is disabled, check whether the indicator **Lock** is lit on, if so, unlock the keypads as the above means.

6: Specifications

■ Specs

Specifications		IT6720
Output Rating	Voltage	0~60V
	Current	0~5A
	Power	100W
Load Regulation	Voltage	<0.01%+3mV
	Current	<0.01%+3mA
Line Regulation	Voltage	<0.01%+3mV
	Current	<0.1%+3mA
Programming Accuracy	Voltage	<0.05%+10mV
	Current	<0.2%+2mA
Read back Accuracy	Voltage	<0.05%+10mV
	Current	<0.1%+2mA
Ripple	Voltage	<2mV rms
	Current	<5mA rms
Dimension	W*H*D	88*175*282(mm)
Weight	Net	<2.5Kg

Memo

[Http://www.itechate.com](http://www.itechate.com)



© Copyright 2006 All Rights Reserved
Ver1.0 /MAR 2008/ IT6720